

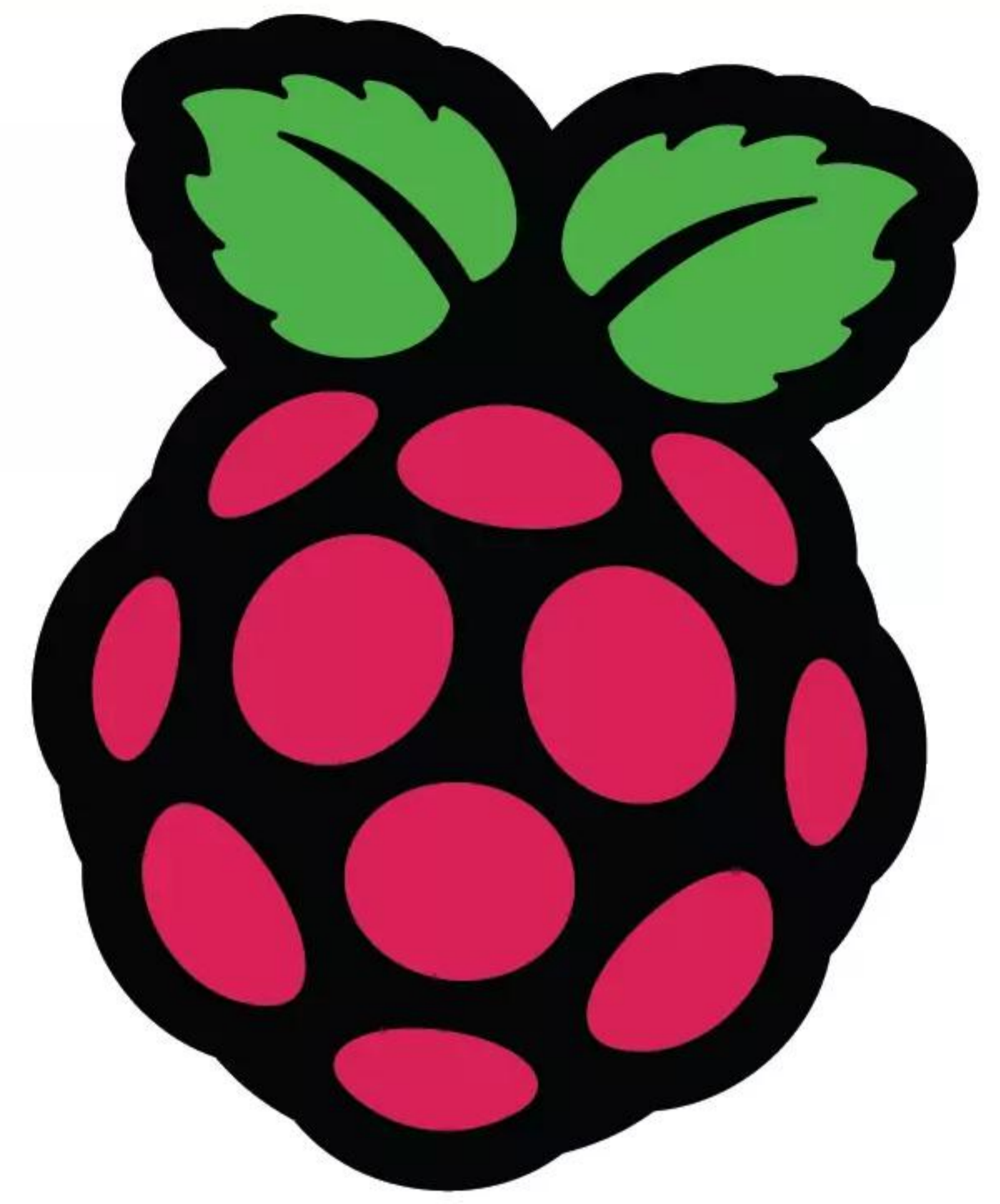

NEW! RASPBERRY PI 5: HUGE SPEED BOOST

# The MagPi



Issue 134 | October 2023 | magpi.cc

The official Raspberry Pi magazine

Introducing...

# Raspberry Pi 5

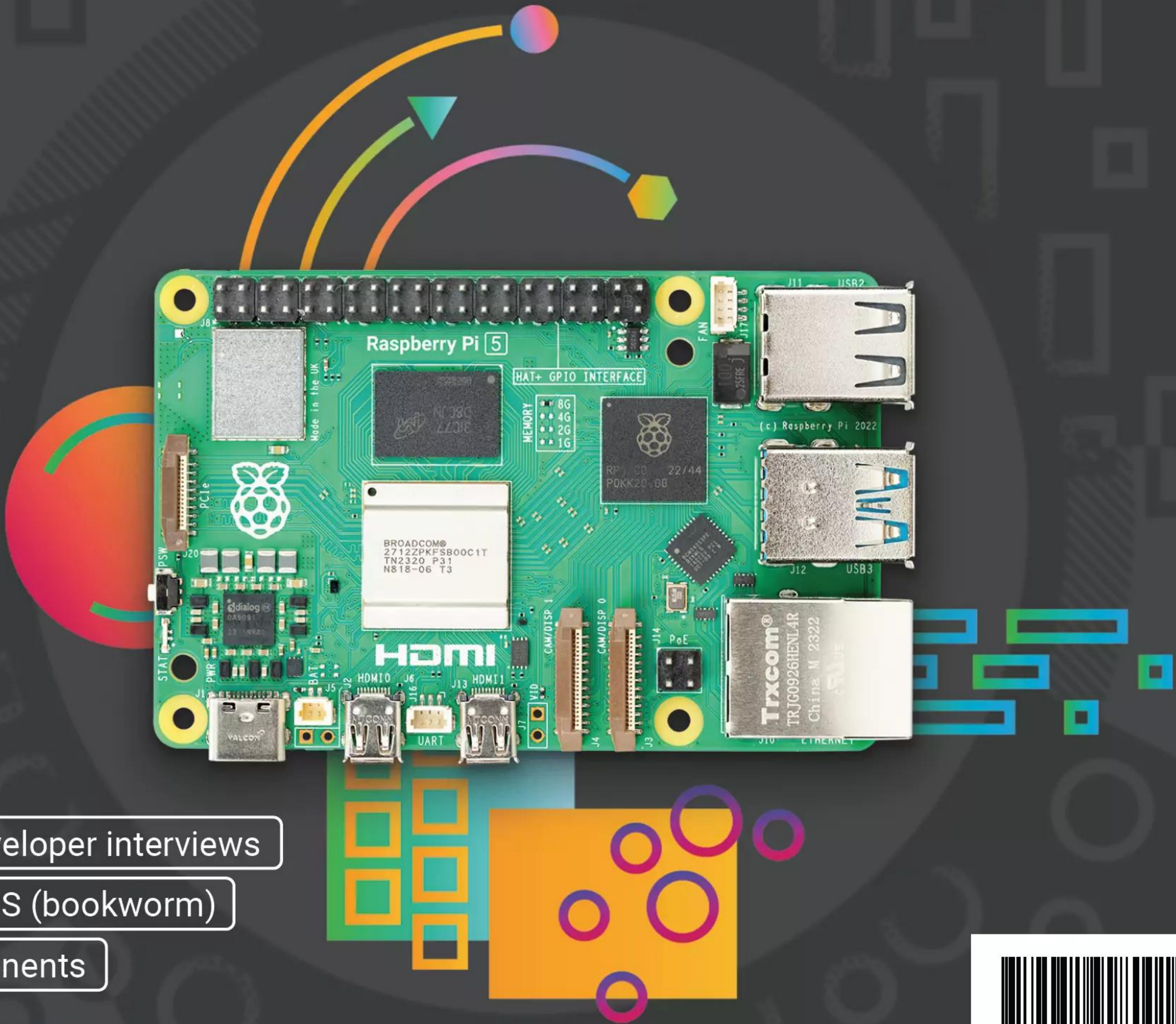

**Exclusive!**

Engineer & developer interviews

Raspberry Pi OS (bookworm)

10 new components

£5.99



**Priority Boarding**

GET YOUR RASPBERRY PI 5 FIRST!



# Industrial Raspberry Pi

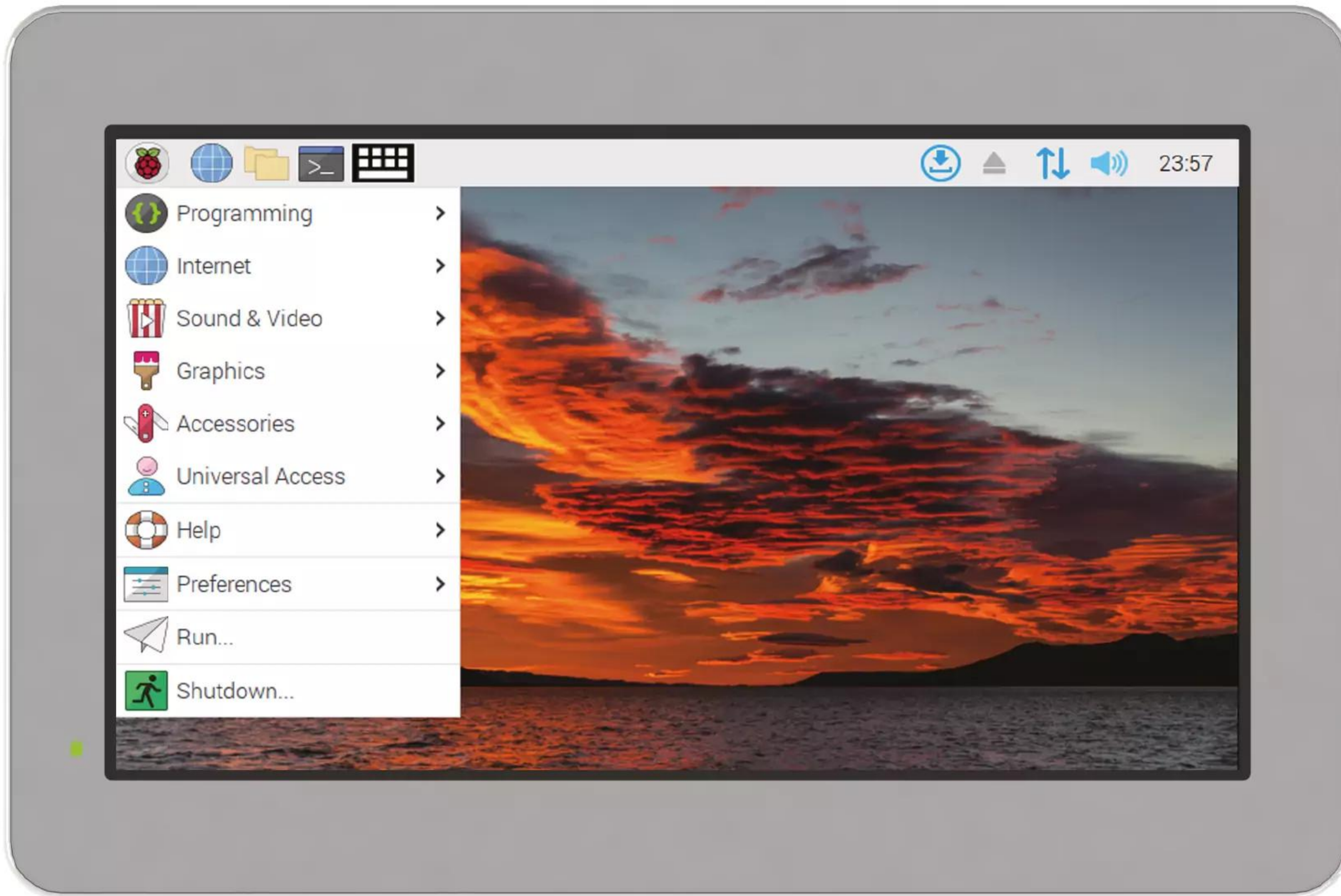

## ComfilePi

The ComfilePi is a touch panel PC designed with high-tolerant components and no moving parts for industrial applications. It features a water-resistant front panel, touchscreen, color LCD (available in various sizes), RS-232, RS-485, Ethernet, USB, I2C, SPI, digital IO, battery-backed RTC (real-time clock), and piezo buzzer.

Use the rear-panel 40-pin GPIO header to expand its features and capabilities with additional I/O boards. The ComfilePi is UL Listed and employs Raspberry Pi Compute Module.

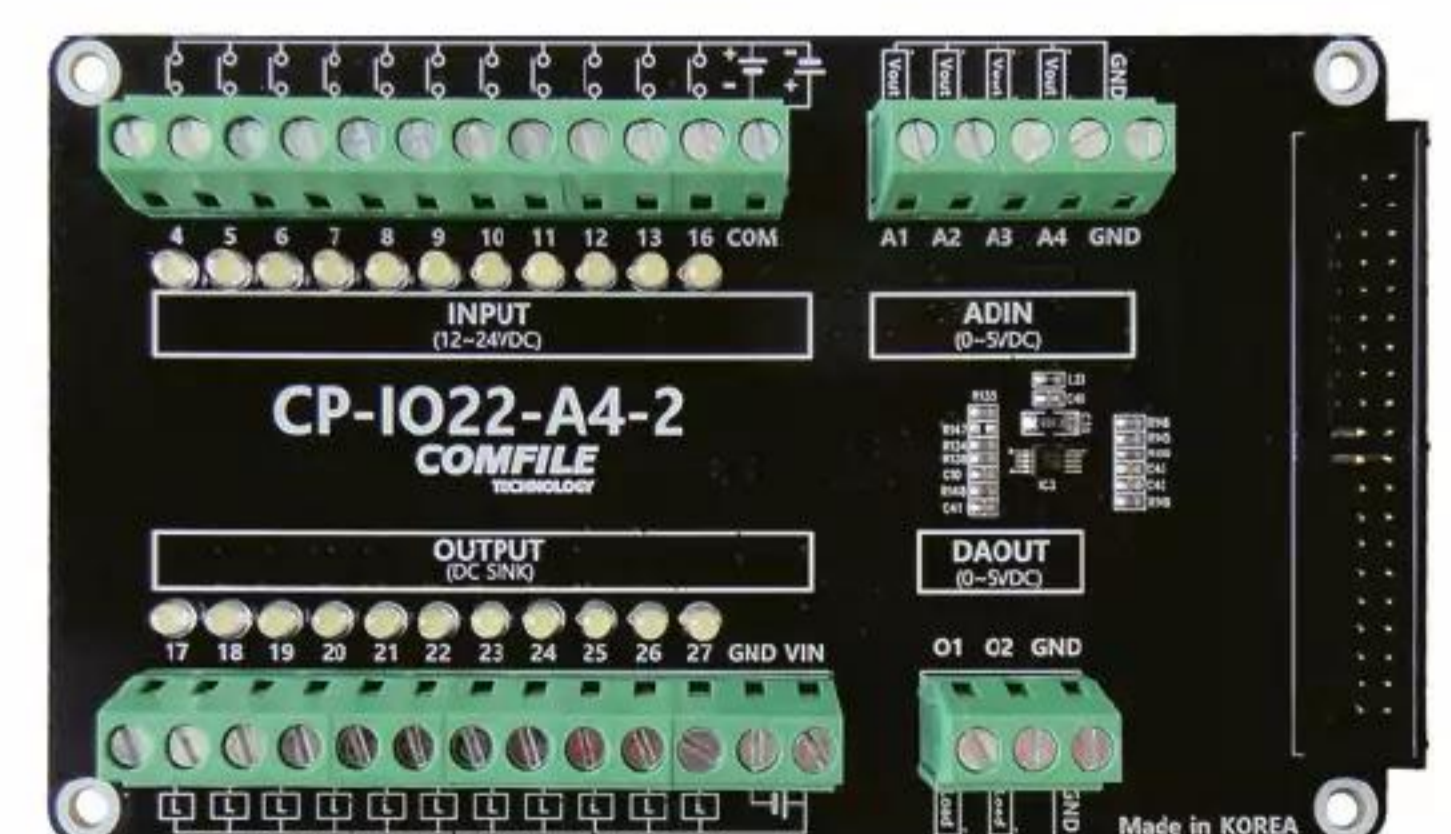

# WELCOME

## to The MagPi 134

**T**here's only one thing everybody is talking about this month – the announcement of Raspberry Pi 5.

Raspberry Pi's upcoming small-factor computer is a giant leap forward in speed and features. Managing to fit so many new components onto the same-sized board is an incredible feat of engineering.

Raspberry Pi 5 is up to three times as fast as the – already speedy – Raspberry Pi 4 it replaces; Raspberry Pi 5 is a full desktop-class computer. It has dual-camera and display support; Raspberry Pi connector for PCIe with an M.2 drive HAT on the way. It even features a power button (hurrah!) and a real-time clock. And it still has the GPIO pins for homemade hacking and making. It's perfect!

There's a lot packed in Raspberry Pi 5, so turn to Page 10 to read all about it. This is the future for Raspberry Pi computing, and we can't wait to see what you all make with it.

Lucy Hattersley Editor



**EDITOR** Lucy Hattersley

Lucy is editor of *The MagPi* and has had a Raspberry Pi 5 on her desk for a while now, slowly watching it coaxed to life by some of the smartest people she's ever known.

[magpi.cc](http://magpi.cc)



GET  
RASPBERRY  
PI 5 **FIRST!**  
**Priority Boarding**  
PAGE 8

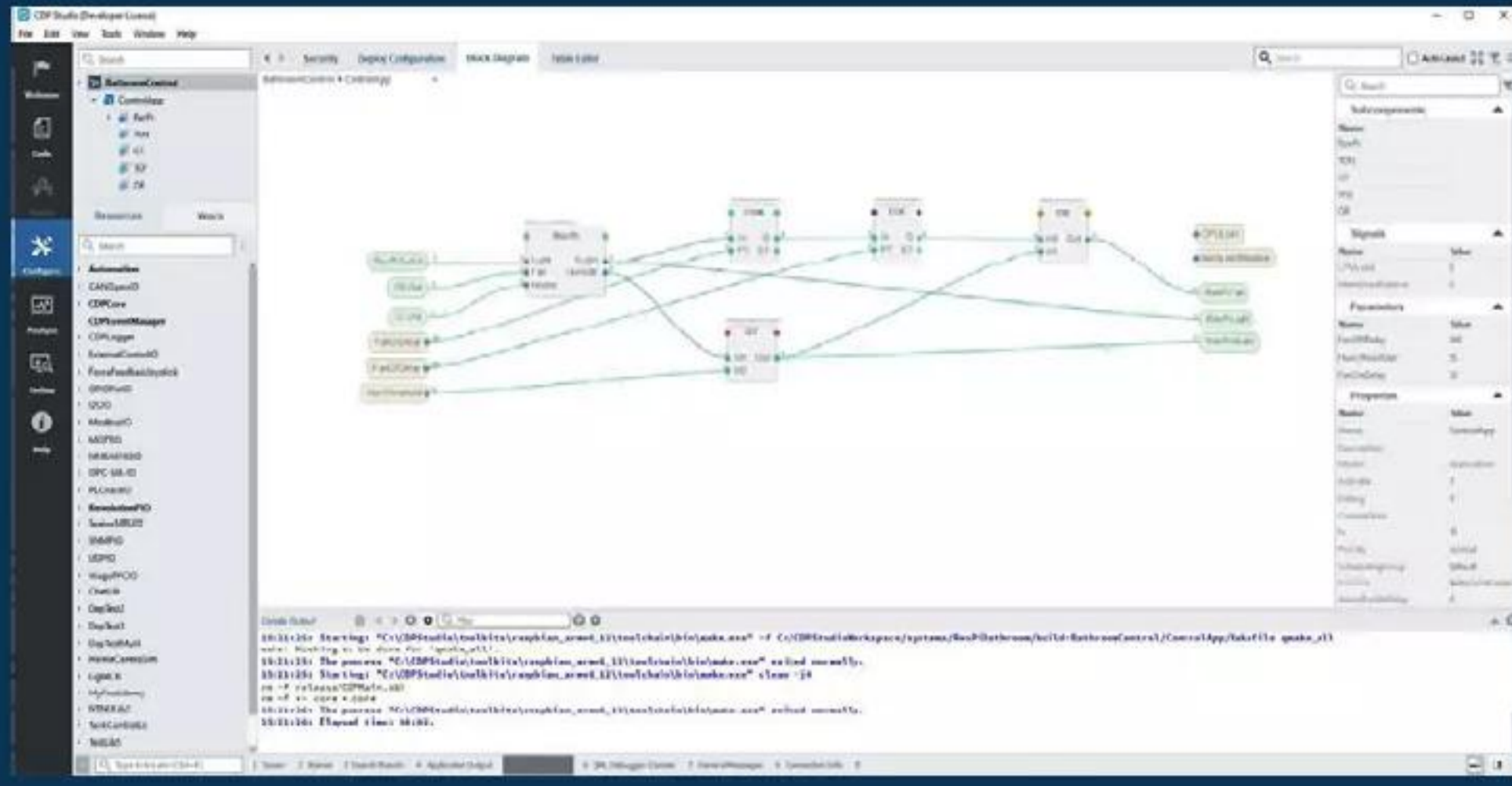

No-code

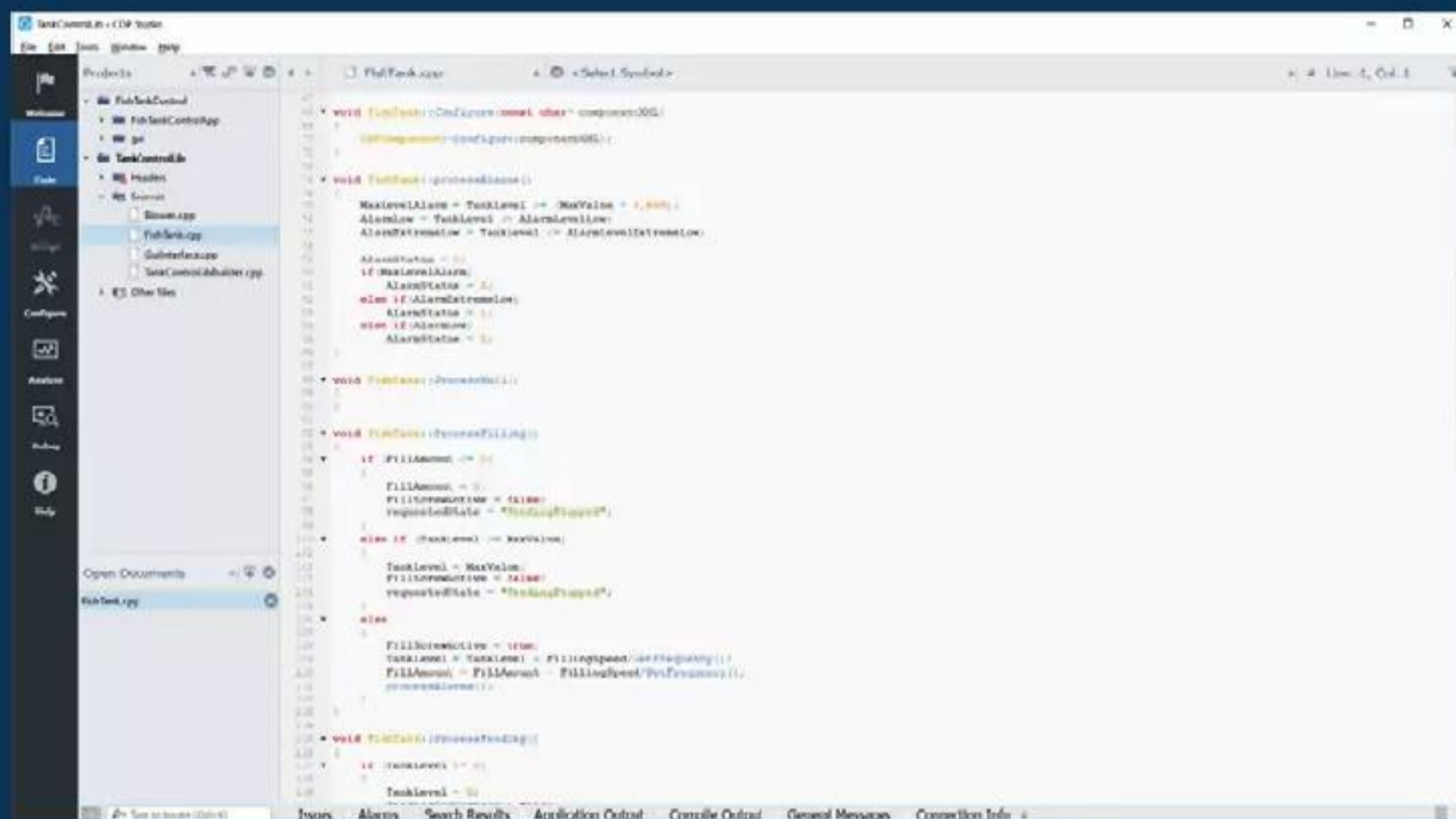

Full-code

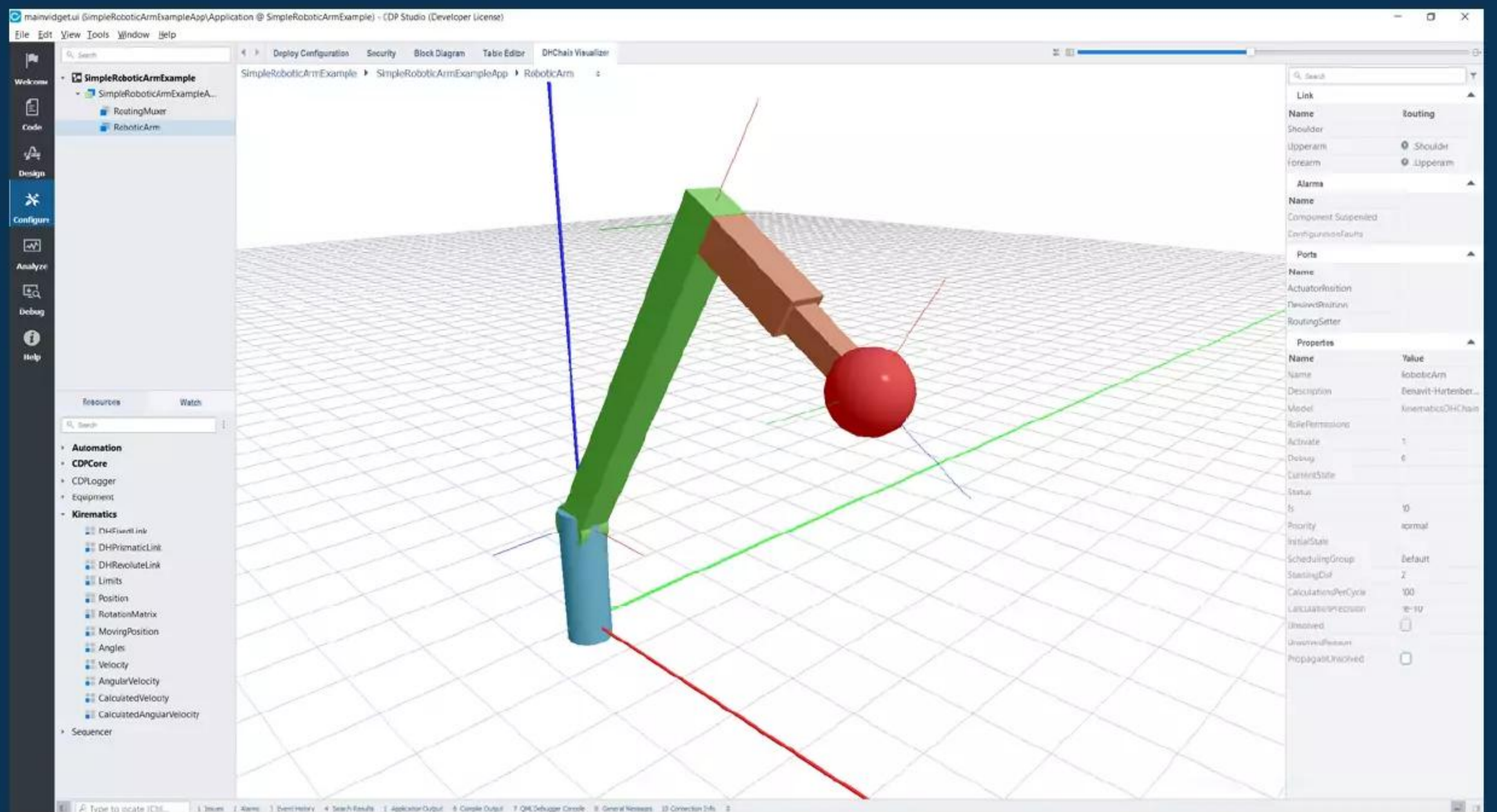

Robotic arm with DHChain configurator and visualizer

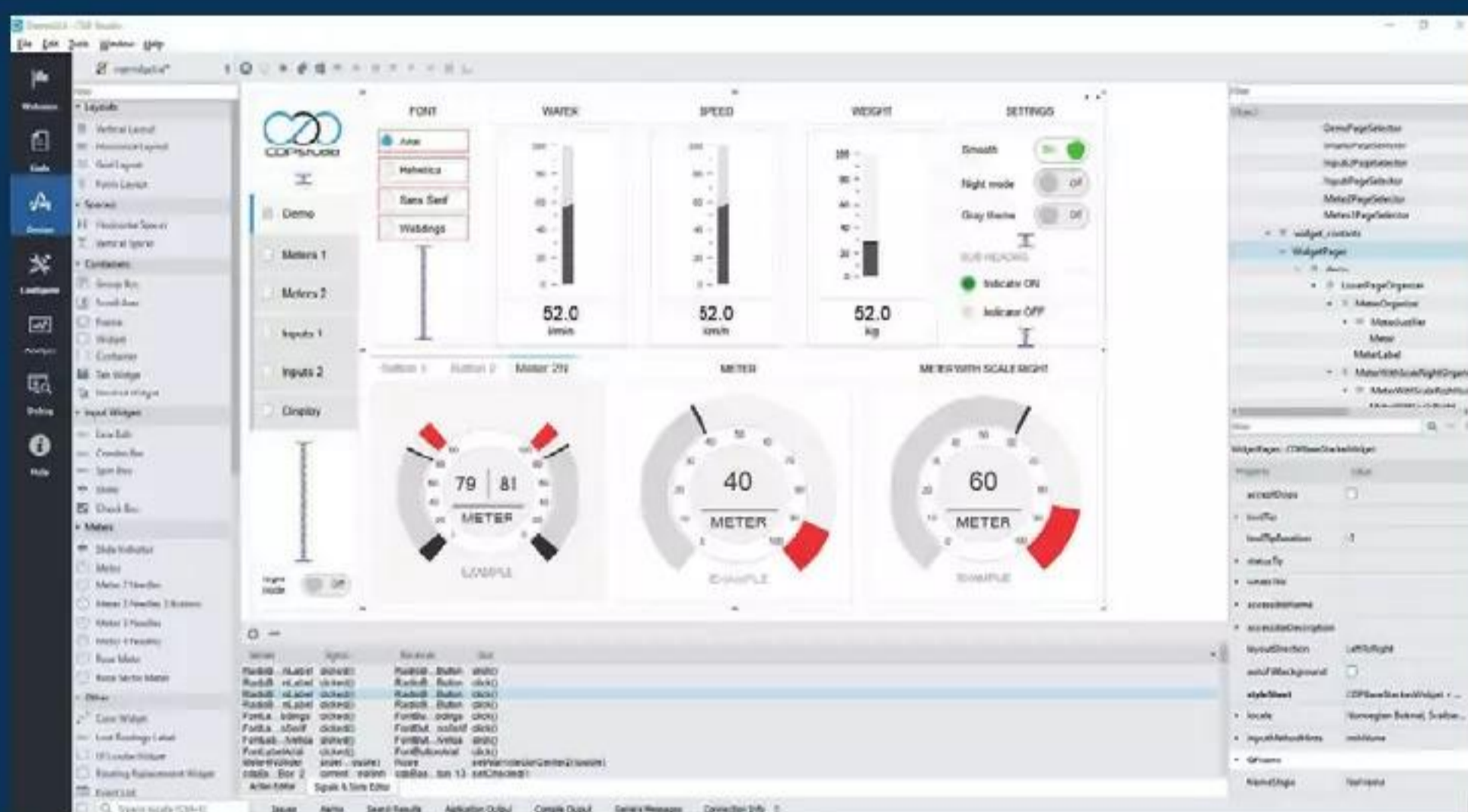

HMI for panel PC and Web

**No-Code**  
**Kinematics and Visualizer**

PROFESSIONAL CONTROL SYSTEM DEVELOPMENT TOOL

# Home projects made easy.

CDP Studio, a great software development tool for your home projects. Build systems for Raspberry Pi, use C++ or NoCode programming, open source libraries, out of the box support for GPIO, I2C, MQTT, OPC UA and more. Create beautiful user interfaces. Built for industrial control system development, **FREE for home projects.**

**cdpstudio.com**

Tel: +47 990 80 900 • info@cdptech.com

CDP Technologies AS // Hundsværgata 8, 6008 Ålesund, Norway



# Contents

► Issue 134 ► October 2023

## Cover Feature

**10** Raspberry Pi 5

## Regulars

- 38** Case Study: Sarawak
- 90** Your Letters
- 97** Next Month
- 98** The Final Word

## Project Showcases

- 24** Bristol Braille
- 28** Giant Dot Matrix Printer
- 30** DispatchPi
- 32** Zelda Guardian security camera
- 36** The Oracle



10

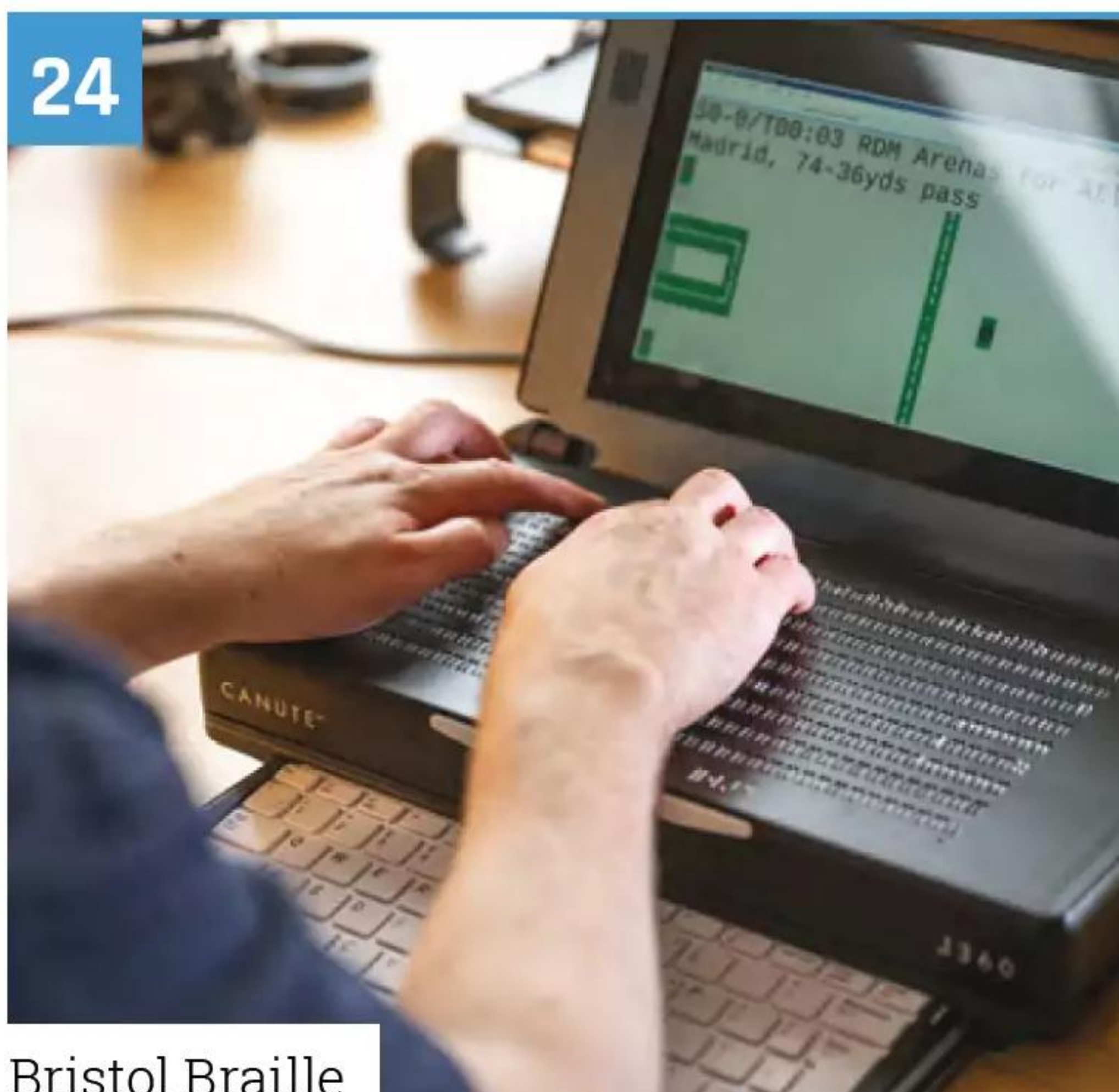

24

Bristol Braille

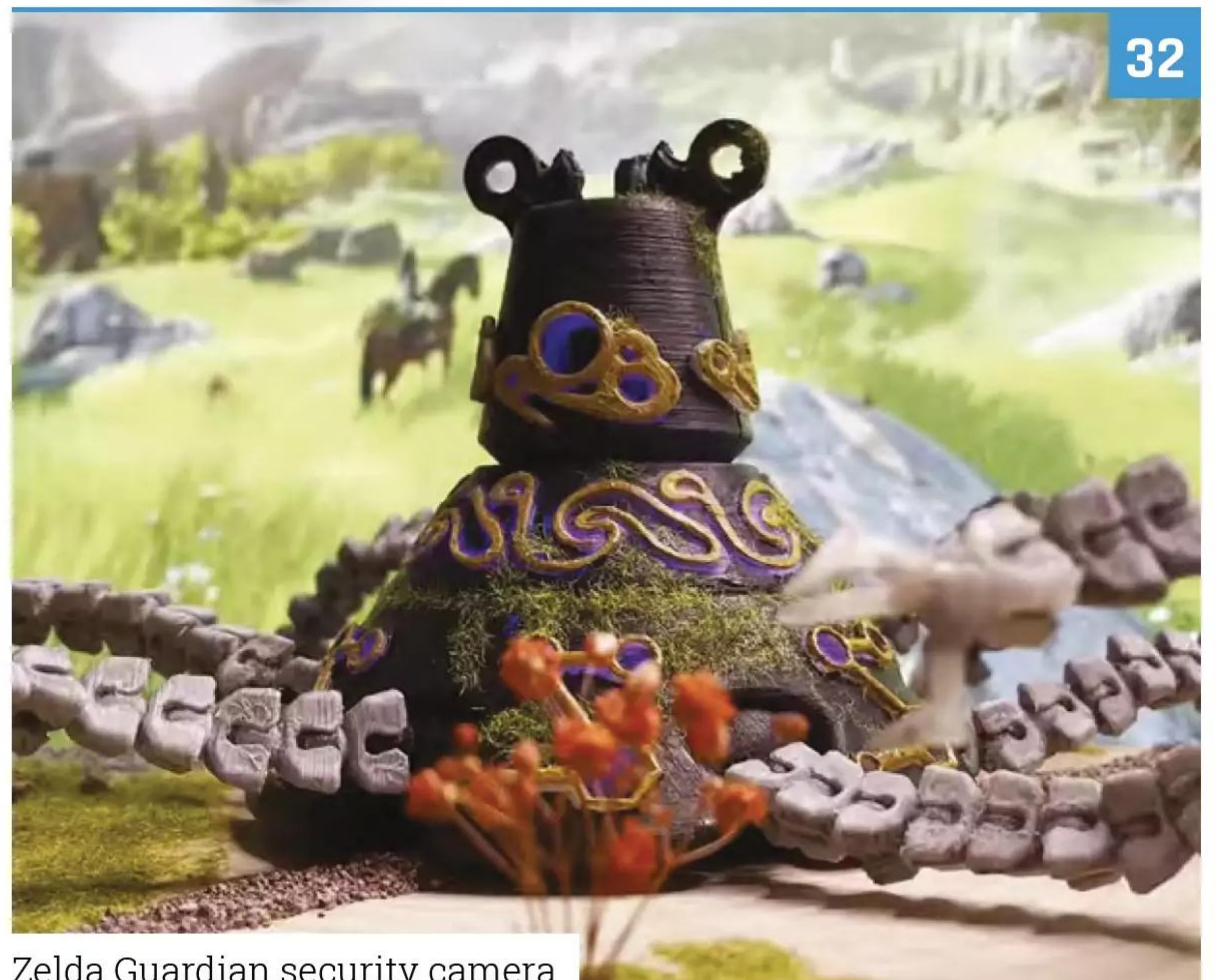

32

Zelda Guardian security camera

The MagPi is published monthly by Raspberry Pi Ltd, Maurice Wilkes Building, St. John's Innovation Park, Cowley Road, Cambridge, CB4 0DS, United Kingdom. Publishers Service Associates, 2406 Reach Road, Williamsport, PA, 17701, is the mailing agent for copies distributed in the US and Canada. Application to mail at Periodicals prices is pending at Williamsport, PA. POSTMASTER: Send address changes to The MagPi, c/o Publishers Service Associates, 2406 Reach Road, Williamsport, PA, 17701.

**Tutorials**

- 42** Make a low-cost oscilloscope
- 46** Control a model railway
- 52** Understanding camera modes
- 56** Practical Python Part 2
- 60** Pico-powered chord keyboard

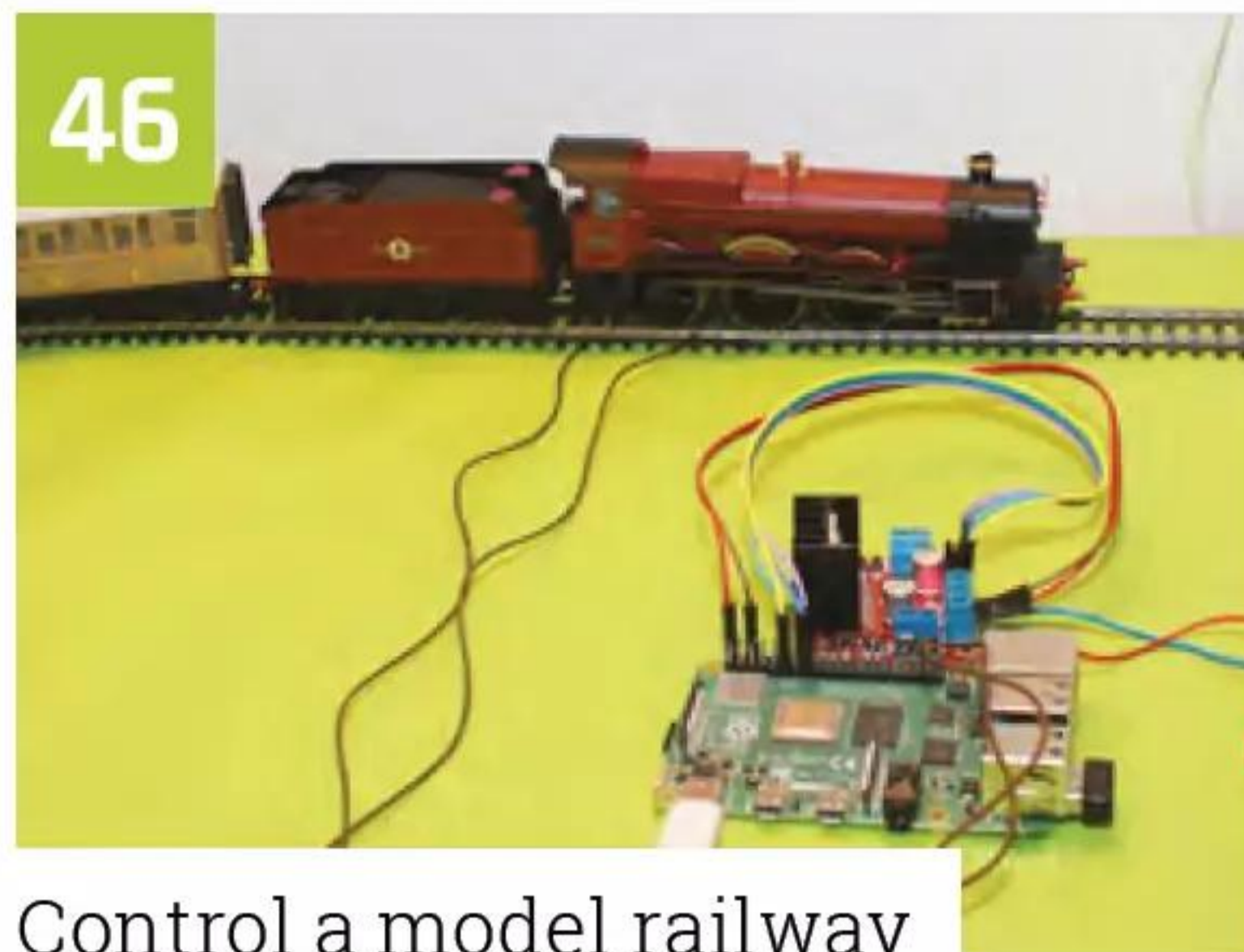

Control a model railway



Understanding camera modes

**The Big Feature**



Trick or treat with Raspberry Pi



Inventor HAT Mini

**Reviews**

- 75** CM4 Mini
- 76** Inventor HAT Mini
- 78** 10 amazing starter kits
- 81** Learn: robotics

**Community**

- 84** Nicholas Provenzano interview
- 86** This Month in Raspberry Pi



Nicholas Provenzano interview

**WIN**  
1 OF 5

**RASPBERRY PI 5 8GB**

**94**

**DISCLAIMER:** Some of the tools and techniques shown in The MagPi magazine are dangerous unless used with skill, experience, and appropriate personal protection equipment. While we attempt to guide the reader, ultimately you are responsible for your own safety and understanding the limits of yourself and your equipment. Children should be supervised. Raspberry Pi Ltd does not accept responsibility for any injuries, damage to equipment, or costs incurred from projects, tutorials or suggestions in The MagPi magazine. Laws and regulations covering many of the topics in The MagPi magazine are different between countries, and are always subject to change. You are responsible for understanding the requirements in your jurisdiction and ensuring that you comply with them. Some manufacturers place limits on the use of their hardware which some projects or suggestions in The MagPi magazine may go beyond. It is your responsibility to understand the manufacturer's limits.

# IDEAS START HERE

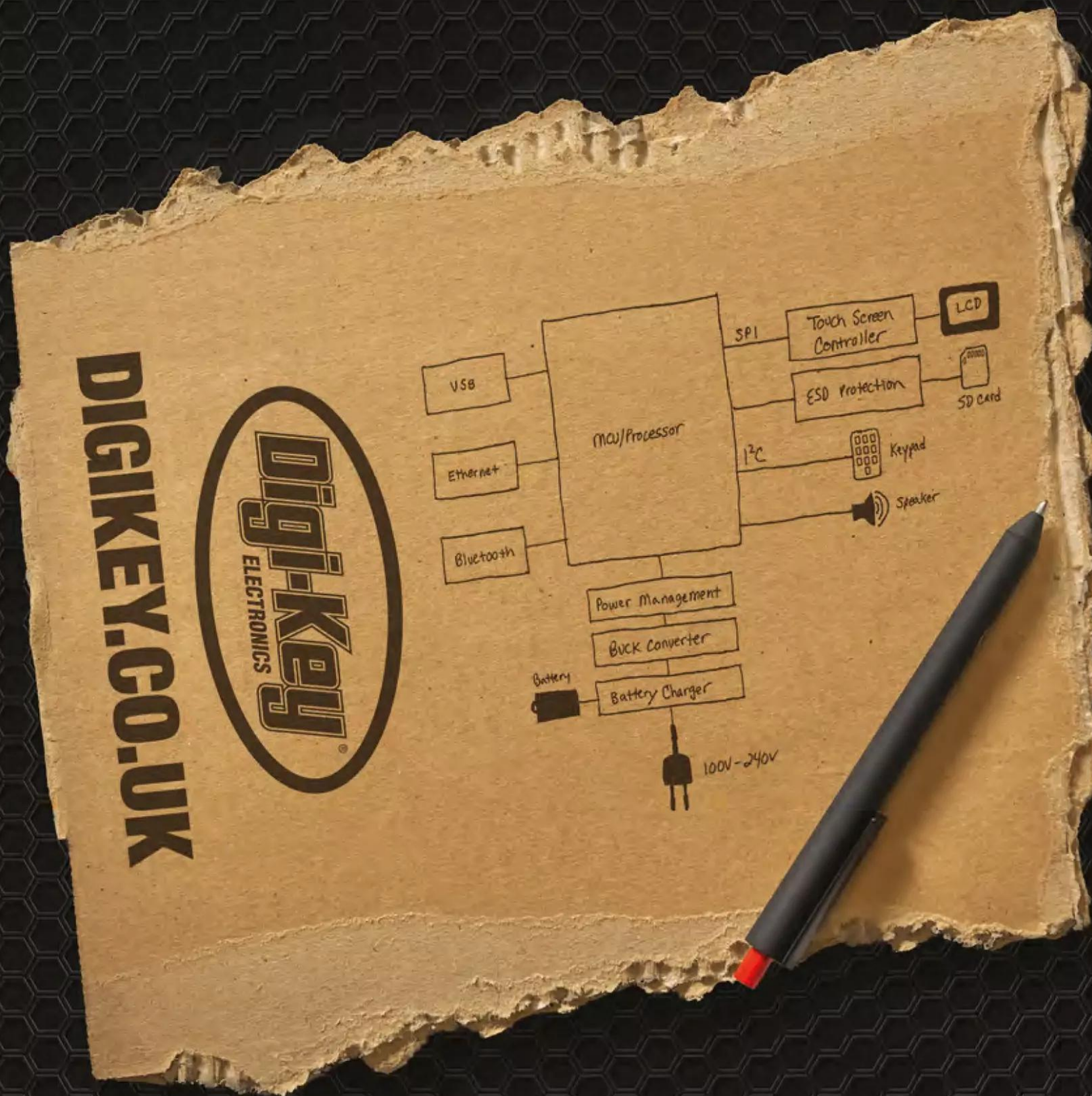

From millions of in-stock parts to the latest new product inventory, we've got everything you need to turn breakthrough ideas into reality.

Get inspired at [digikey.co.uk](https://www.digikey.co.uk) or call 0800 587 0991.



# Raspberry Pi **5**

## PRIORITY BOARDING

We've reserved Raspberry Pi 5 boards  
*for The MagPi subscribers*

GET YOUR  
RASPBERRY PI 5  
**FIRST!**

Want to get Raspberry Pi 5 sent to you in the first week of release? With Priority Boarding you can pre-order your Raspberry Pi 5 (4 GB or 8 GB) and it'll get sent out first.

Raspberry Pi has set aside thousands of Raspberry Pi 5 computers for The MagPi and HackSpace print subscribers to buy. We've enough for everybody who subscribes to The MagPi ([magpi.cc/subscribe](https://magpi.cc/subscribe)) or HackSpace magazine ([hsmag.cc/subscribe](https://hsmag.cc/subscribe)).





## How it works!

If you have a print subscription to The MagPi ([magpi.cc/subscribe](https://magpi.cc/subscribe)) or HackSpace magazine we will have your email on file. We'll send each of our subscribers a unique code in the next few days. Click the link in the email and it will take you to a site where you can pre-order and pay for your Raspberry Pi 5. Customers in the US and Canada will be directed to PiShop; while customers in the UK, Europe, and the rest of the world will be directed to The Pi Hut.

## Get started

New subscribers to The MagPi will get a Priority Boarding code when they sign up. So don't delay. Take out a subscription today ([magpi.cc/subscribe](https://magpi.cc/subscribe)). You'll be able to buy your Raspberry Pi 5 first and get incredible Raspberry Pi tutorials, projects, and community events every month.

*Click here for more information:*

**[magpi.cc/priorityboarding](https://magpi.cc/priorityboarding)**

**TERMS & CONDITIONS** Your Priority Boarding code will be emailed to everybody with a print subscription to The MagPi or HackSpace magazine. People who subscribe to both magazines will get two codes. Print only! Priority Boarding does not apply to people with App Store, Google Play, Zinio, PDF contributions, or other paid-for subscriptions. Each code will entitle you to purchase 1x (one) Raspberry Pi 5 model (either 4 GB or 8 GB) for the standard retail price and delivery. Multiple codes need to be used individually. This is a limited offer and is subject to change or withdrawal at any time.



# Introducing...

# Raspberry Pi 5

Up to **three times faster**, absolutely packed with new features, and available to *The MagPi* subscribers first, Raspberry Pi 5 is everything we wanted from a new Raspberry Pi computer

By Lucy Hattersley

**R**aspberry Pi 5. Those are all the words you need to hear this month. This is the moment we've been waiting for.

The next generation of Raspberry Pi has been in development for years, and we can finally lift the wraps on the full specifications, design process and features on the new board.

For the first time, this computer features silicon designed in-house by Raspberry Pi. The new chip RP1 allows Raspberry Pi 5 to deliver a huge improvement in peripheral performance and functionality. It's also opened up a lot of space on the board, which now features 10 new components on the classic form factor.

Raspberry Pi 5 is still the single-board



computer we know and love, but at its heart sits a 2.4GHz quad-core Arm Cortex-A76 CPU that makes Raspberry Pi 5 between two and three times as fast as its predecessor.

Two models are available at launch: 4GB and 8GB. Both with SDRAM running at 4267MHz.

The board remains the same size and dimensions but is packed with new features. It has a power button next to the status LED, a real-time clock, a Raspberry Pi connector for PCIe to support fast peripherals including NVMe drives (there is still an SD Card slot, now running twice as fast as before); there are two 4-lane DSI/CSI sockets, which support either two camera modules, two displays, or one of each. It has two HDMI connectors and now you can drive two full 4K displays both running at 60fps, up from 30fps on Raspberry Pi 4. There's even an UART connector, and a fan connector to provide power to a new case with an integrated fan.

Raspberry Pi 5 will start shipping in late October, and subscribers to *The MagPi* can pre-order theirs today with Priority Boarding (page 8)

Raspberry Pi 5 is an excellent upgrade to our favourite micro-computer. This is the springboard we've been bouncing on for months, and we can't wait to dive in.

## When is it out?

Raspberry Pi 5 will be available in 4GB and 8GB models from late October. Subscribers to *The MagPi* will get a pre-order code to buy Raspberry Pi 5 in the first wave (see page 8).

Locate a reseller near you at the Raspberry Pi product page ([magpi.cc/products](https://magpi.cc/products))

## 10 New Components

Raspberry Pi's engineers have squeezed an incredible amount of extra tech onto the same-sized board

- 1 BCM2712 Broadcom chip
- 2 RP1 I/O controller
- 3 Power button
- 4 Dual DSI/CSI sockets
- 5 Raspberry Pi connector for PCIe
- 6 UART debug connector
- 7 Fan & Active Cooler power connector
- 8 Real-time clock with battery connector
- 9 Power-management IC
- 10 Heatsink mounts

# Get to know Raspberry Pi 5

Your in-depth guide to Raspberry Pi's new micro-computer

## Specifications

2.4GHz 64-bit quad-core Cortex-A76 processor

### VideoCore VII GPU

4GB / 8GB LPDDR4X SDRAM at 4267MHz

### microSD (SDR104 supported)

2 × micro HDMI ports (supports up to 4Kp60)

2 × USB 3.0 ports

2 × USB 2.0 ports

2 × 4-lane connectors for camera or display peripherals (sold separately)

Gigabit Ethernet port

802.11b/g/n/ac wireless

Bluetooth 5.0

PoE-capable (requires PoE HAT, sold separately)

Raspberry Pi connector for PCIe (requires M.2 HAT, sold separately)

Power button

Fan connector

UART connector

Real-time clock, with connector for battery backup

5V/5A USB-C power supply recommended, 5V/3A minimum requirement (sold separately)

### RAM

Here we have 8GB of LPDDR4 in the form of a Micron chip



### PCIe

A new PCI Express high-speed expansion bus is positioned on the edge of the board. An upcoming adaptor will enable an M.2 drive to be connected directly to Raspberry Pi 5, along with other custom devices.

### Power

The Renesas/Dialog DA9091 "Gilmour" power management chip is custom silicon that provides power supplied to the various components

### Power Button

A power button, one of the most heavily requested features, has finally been added to Raspberry Pi 5. The status LED sits adjacent



### USB-C power

Raspberry Pi 5 is powered by an external USB-C power supply

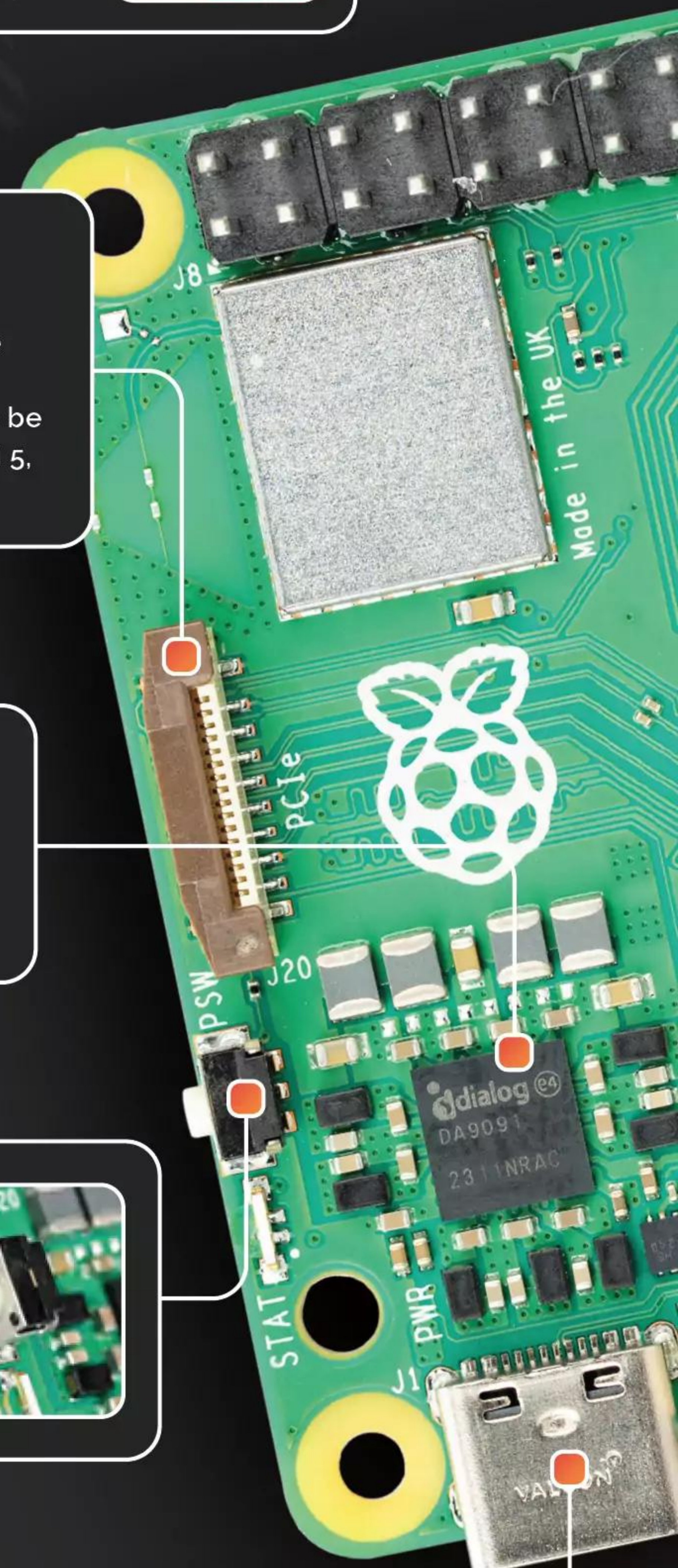

### BCM2712 chip

The silver heart of Raspberry Pi 5 is the new Broadcom BCM2712 SoC (System-on-chip) architecture. It contains an ARM Cortex-A76 quad-core CPU running at 2.4GHz and a new VideoCore VII GPU that supports OpenGL-ES 3.1, Vulkan 1.2.



### Fan socket

A new on-board fan socket is used to provide power to the fan-enabled case and Active Cooler accessories

### Active Cooler

There are two extra holes on the board. These are to mount the Active Cooler attachment

### Raspberry Pi RP1

The new Raspberry Pi RP1 chip handles the bulk of input and output (I/O). It is connected to BCM2712 via PCI Express.



### Dual 4Kp60 HDMI

There are two micro-HDMI ports; Raspberry Pi 5 can drive dual displays, both at 4Kp60 resolution

### Dual CSI/DSI

The CSI and DSI ports have been combined into two multipurpose CSI/DSI ports (now using the denser connector pinout found on Raspberry Pi Zero). You can connect either two displays, or two cameras (or one of each)



### UART

Between the micro-HDMI ports sits a new UART connector, which can be used to control Raspberry Pi 5 in headless mode

### RTC BATTERY

The battery connector is used to connect a battery (or supercapacitor) to provide backup power to the Real Time Clock

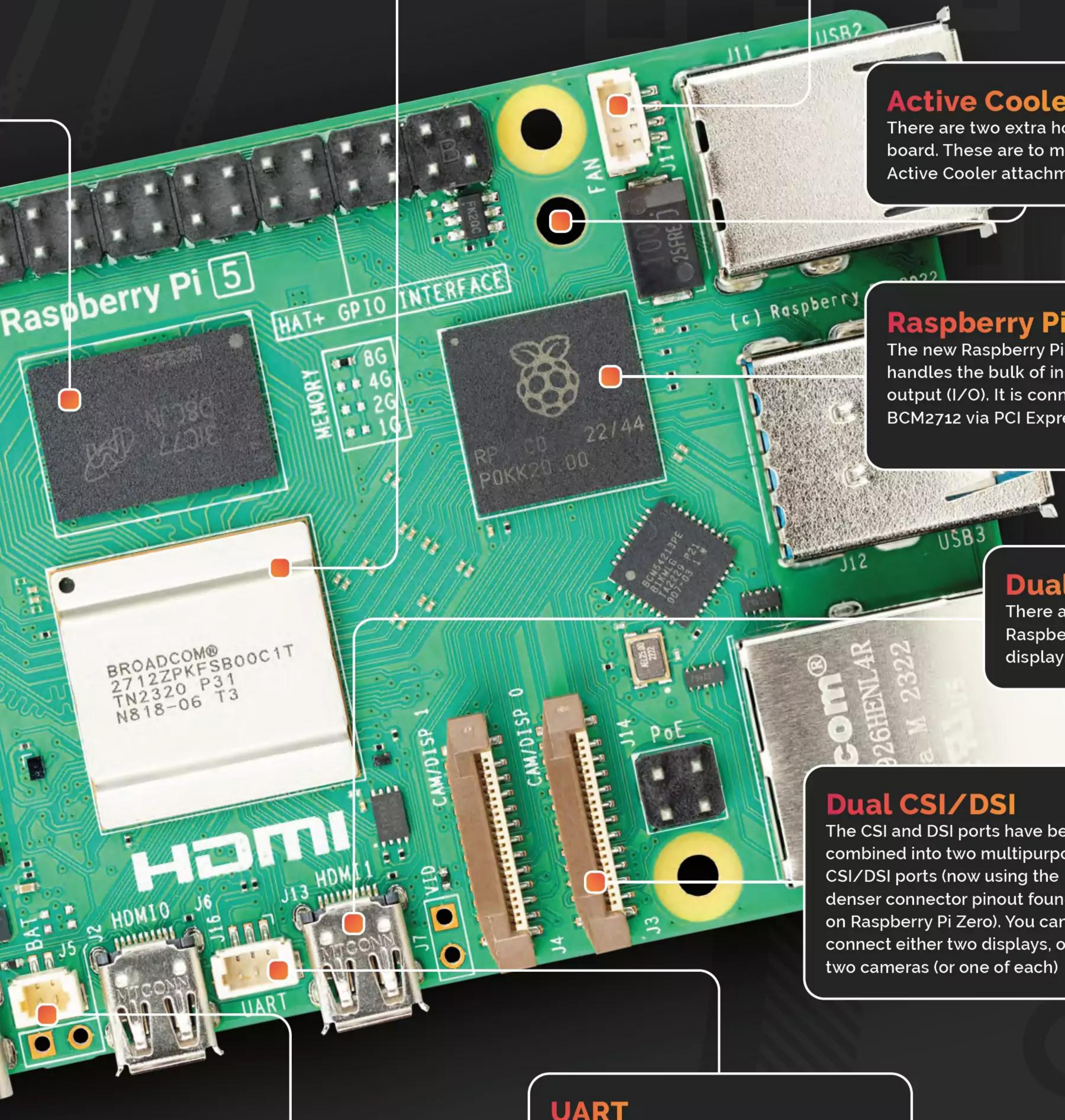

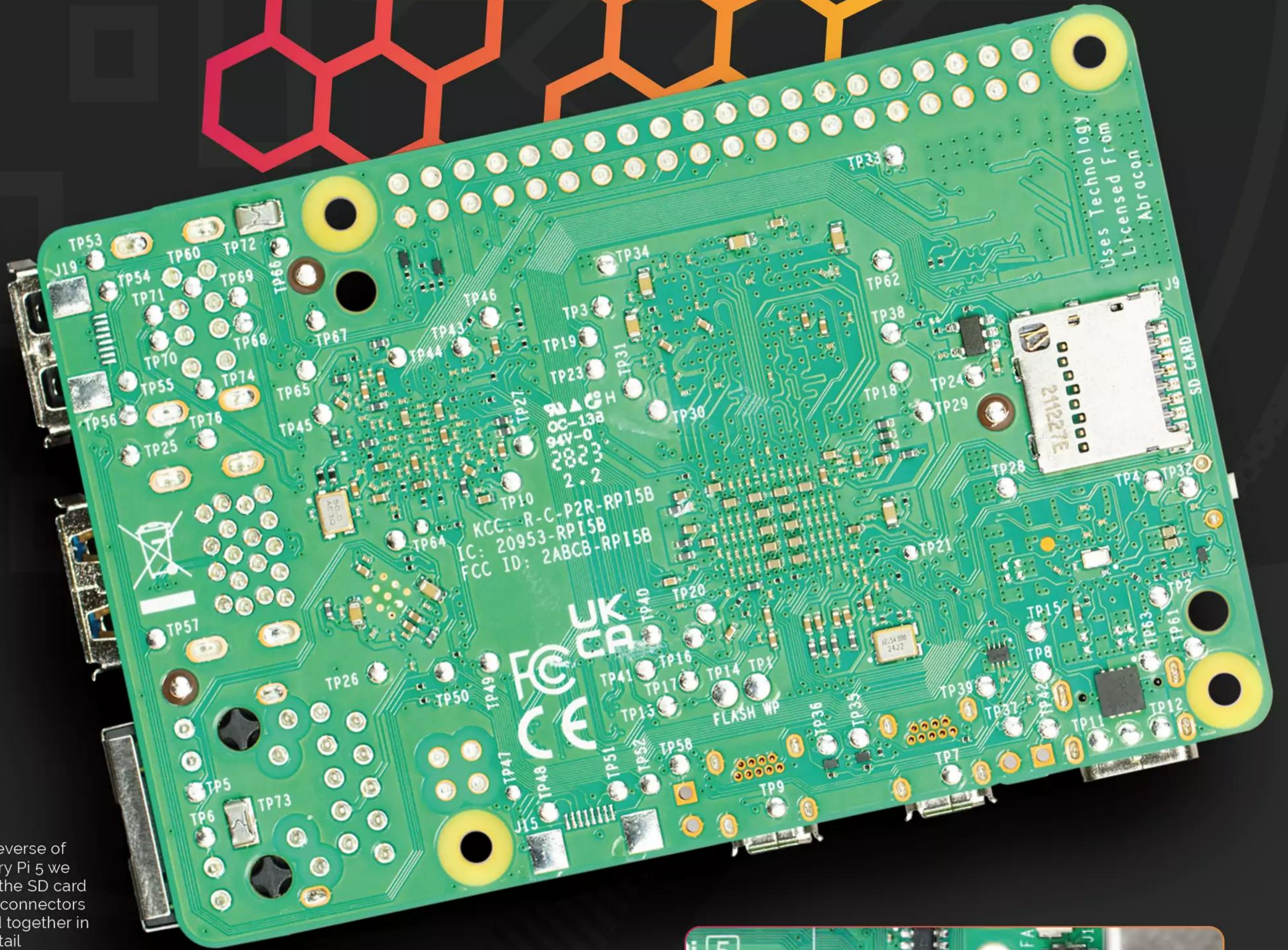

▶ On the reverse of Raspberry Pi 5 we can see the SD card slot and connectors soldered together in more detail



## Battery

Raspberry Pi 5 has a two-pin JST (Japan Solderless Terminal) port marked BAT. This is used to connect a battery (or other power source) to the new Real Time Clock (RTC).

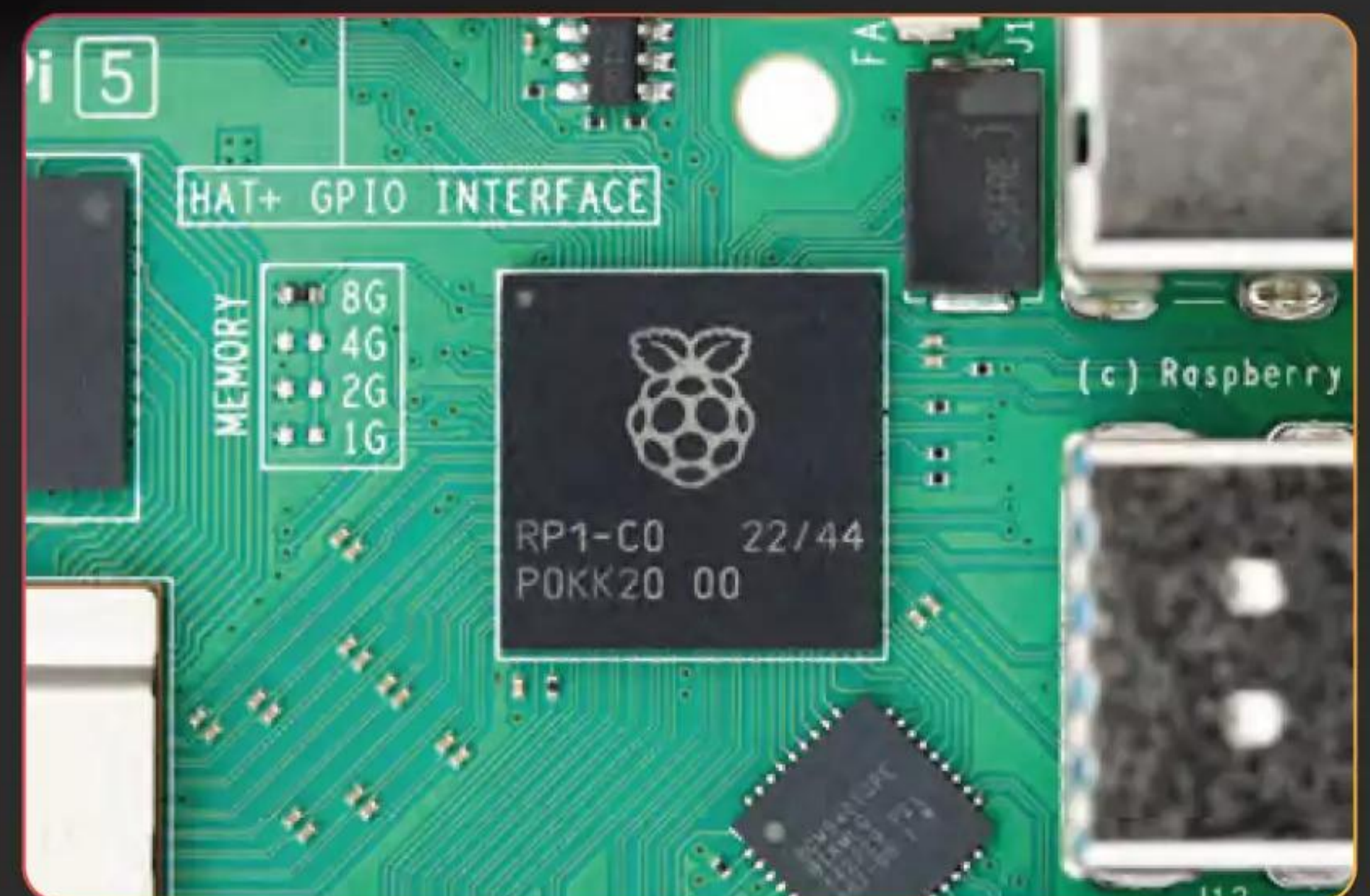

## Raspberry Pi RP1

Raspberry Pi has been developing RP1 for a long time. RP1 is a new communications chip. RP1 is custom silicon designed by Raspberry Pi that connects the CPU to the 'slower' components on the board (of course, these slow components can still function incredibly quickly).

In the case of Raspberry Pi 5, RP1 controls the input and output (I/O) for the GPIO pins, USB ports, CSI/DSI ports and Ethernet. It is connected to the BCM2712 SoC via a 4-lane PCI-express bus. The GPIO pins have the same function and layout as before, so most HATs and other accessories will be compatible.

# Explore the new Raspberry Pi OS

A new operating system is also announced:  
Raspberry Pi OS based on Debian 'bookworm'

**R**aspberry Pi 5 can run a variety of different operating systems and, thanks to its speed increase, you have a lot of Linux and other ARM-based OSes to choose from.

Raspberry Pi OS is still our preferred operating system. Built on top of Debian, it is a Linux operating system custom-built for Raspberry Pi hardware.

With Raspberry Pi OS you get easy access to hardware features like the GPIO pins, and Camera Module, and can be sure everything is being tested. Out shortly before Raspberry Pi 5 is available will be a new version of Raspberry Pi OS, based on Debian 'bookworm'.

Raspberry Pi 4 and Raspberry Pi 5 hardware running bookworm replaces the X11-based LXDE desktop with a Wayland system using Wayfire as the window manager. This software is used to draw windows on the screen and is highly customizable. Raspberry Pi OS has a slicker windowing system with subtle animations. The desktop background is still drawn by pcmanfm but has been modified to talk to Wayland. The taskbar looks the same but is a customized version of Wayfire's wf-panel, which also includes ports of the existing plugins.

The experience of Raspberry Pi OS (bookworm)

▼ Firefox joins Chrome as a web browser option

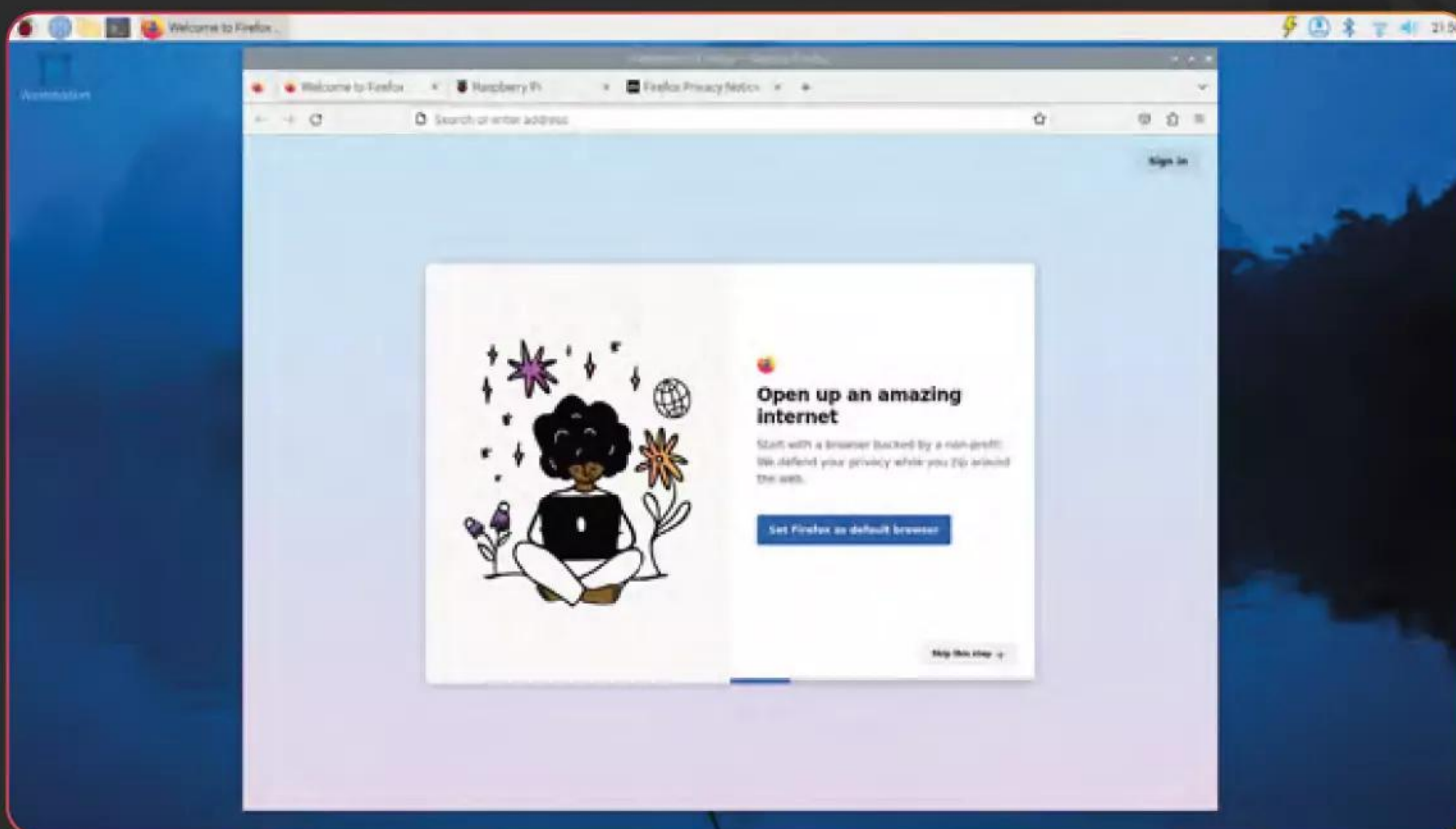

on Raspberry Pi 5 is fantastic, offering similar levels of interactive speed as a desktop-class computer. It has the same feature set and design as before, but with vastly improved performance and a slightly slicker design: windows fade in and out with a smooth animation.

There are new desktop images as well, but the overall style is in keeping with earlier versions of Raspberry Pi OS.

There is also a new Network Manager ([networkmanager.dev](https://networkmanager.dev)) which replaces dhcpcd. Network Manager is becoming the standard networking tool on many Linux distributions, while dhcpcd was relatively uncommon.

“ The experience of Raspberry Pi OS (bookworm) on Raspberry Pi 5 is fantastic ”

Pipewire is now being used instead of PulseAudio to handle audio and video. This is used by some tools to provide services like screen sharing for Wayland, so it is a useful enabling technology.

Finally, Firefox joins Google Chrome as a browser option in the Recommended installation of Raspberry Pi OS. Firefox enables browser sync across Raspberry Pi and other operating systems, a feature missing from Chrome.

# Raspberry Pi 5 Accessories

Modular design is more feature-packed than ever

## Raspberry Pi Case

Alongside Raspberry Pi 5 comes a new case with powerful new features.

It retains the white and red modular scheme of the original case, and now contains four separate compartments.

There is the red base, which Raspberry Pi 5 sits on, with a white frame in the middle. New to this case is a clear shelf with a fan on board (that connects to the fan socket next to the Ethernet port). This shelf has a cutout section enabling access to the GPIO pins, and a final lid, with airflow spacing, covers everything into a neat package. Inside the box you will also find a heatsink to attach to Raspberry Pi 5's main processor and four stick-on rubber feet.

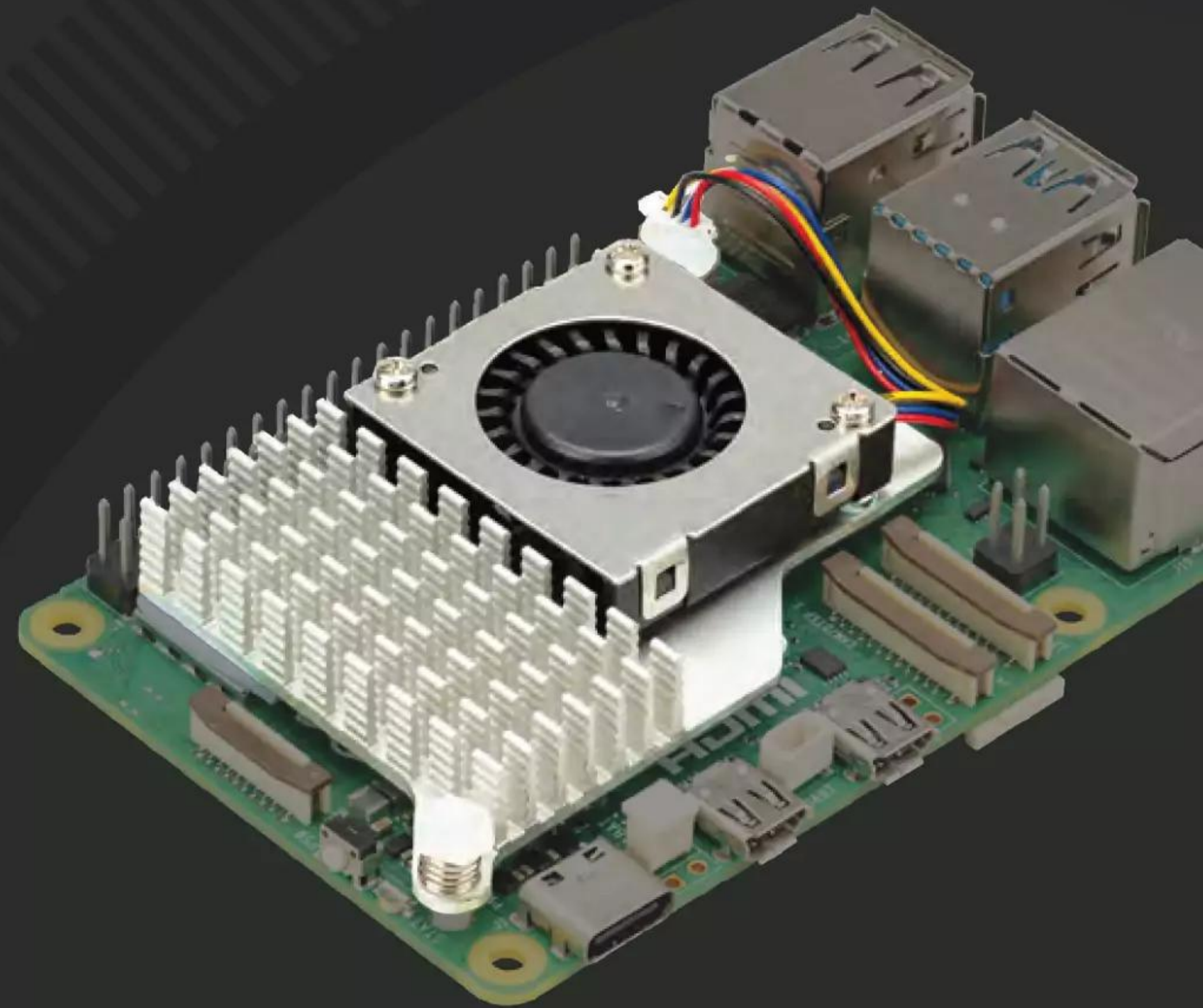

## Active Cooler

An alternative cooling solution is also available, called the Active Cooler. It may look like a fan, but this is an extruded heatsink with fins and a blower (a fan that sucks air in from the top and directs it sideways). It connects directly to the board for power. You'll notice two extra holes on Raspberry Pi 5's board to attach the Active Cooler, which is connected with pushpins.



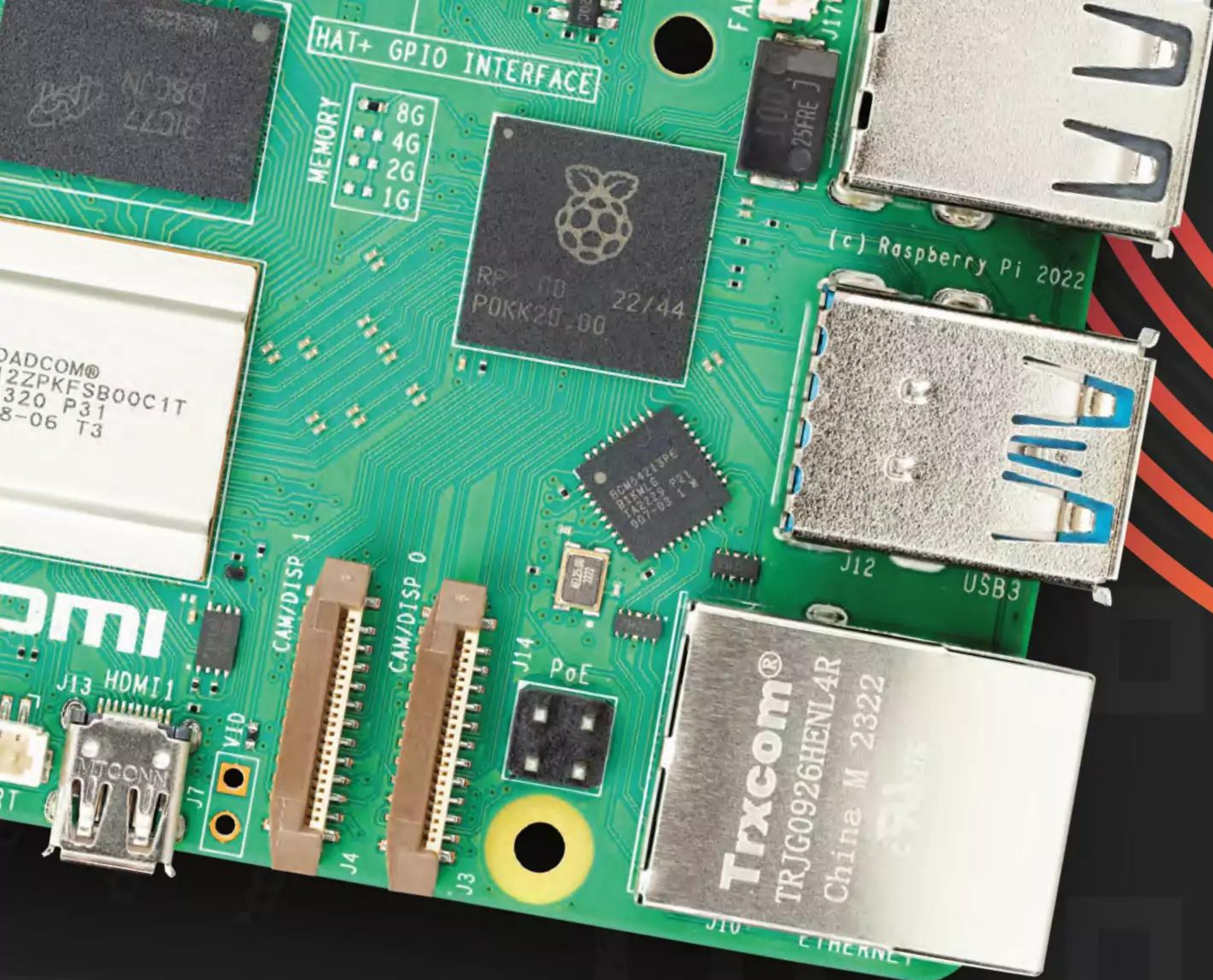

## Raspberry Pi Power Supply

Raspberry Pi 5 requires a 25 W (5 V/5 A) USB-C power supply to support maximum current to downstream USB devices. With only low-power peripherals like mice and keyboards attached, you can safely continue to use a 5 V/3 A (15 W) PSU as a minimum requirement. In testing, we have been using the 15 W power supply without the Active Cooler or Raspberry Pi Case without issues.

To power Raspberry Pi 5 to the best of its abilities, you should invest in the new Raspberry Pi Power Supply, which provides 25 W of power via a USB-C connection. The Power Supply's input voltage is 100–240 V~50/60 Hz, and output modes are:

- 5.1 V/5 A (25.5 W)
- 9 V/3 A (27 W)
- 12 V/2.25 A (27 W)
- 15 V/1.8 A (27 W)



## PCI Express M.2 adapter

We can exclusively reveal that Raspberry Pi is working on a PCI Express adapter to connect M.2 storage drives directly to Raspberry Pi 5. We'll have more information on this soon because the L-shaped design is being finalised. In the meantime, here is a photo of the adapter cable that will connect to the M.2 HAT. 

# Behind the scenes with

# Raspberry Pi

# 5



BIO

**James Adams**

CTO (HARDWARE)

James has been at Raspberry Pi for over ten years. You'll find his signature on a Raspberry Pi 5 under the USB ports.

Building new hardware, new silicon, and new docs

**It's been over four years since Raspberry Pi 4 was released, but parts of Raspberry Pi 5 have been in development for far longer.** We

sat down with James Adams, CTO (Hardware) at Raspberry Pi, to talk about the new technologies on the board and what they bring to Raspberry Pi.

## RP1 - an in-house southbridge

Raspberry Pi 5 is coming out in October 2023, yet one of its most important new components is a chip that has been in development since 2015; RP1. Technically, it's the first bit of Raspberry Pi silicon (hence the number) as it entered development long before RP2040. Over the years, we've heard inside Raspberry Pi of this 'Project Y' device being planned for inclusion first in for Raspberry Pi 3B+, and then in Raspberry Pi 4.

"This is our longest running chip development program," says James Adams. "I guess it's the reason that we built ourselves a chip team in the first place... the idea is that we separate out Raspberry Pi I/O away from the main processor. That allows the main processor to be much simpler and you can iterate it more quickly, as it's almost a purely digital design."

You may have noticed that the layout of the USB and Ethernet ports have swapped back to the original Model B+ arrangement after they were reordered on Raspberry Pi 4. We wanted to know how RP1 had informed this, along with the layout of the board in general.

"This is a result of our having, for the first time, total freedom in specifying the pinout of the various silicon devices on the board. So, the Model B+ board layout came first. That then informed the pinout of RP1, and then the pinouts of the other device," continues James. "In the middle of the board you'll see a big sort of multi-lane highway, and that's a four-lane PCI Express (PCIe) bus.

"If you had to swap any of those lanes over, it would be a disaster. So, we designed the pinouts of RP1 and BCM2712 (with Broadcom) to match. It's the same story with the power supplies: we've designed the [power supply] chip with Dialog (now Renesas) to make sure the various voltage rails come out in the right order relative to the devices that consume them."

## Project why?

The initial concept for a Raspberry Pi southbridge, back in 2015, was to build a device which could bridge the spare MIPI camera and display channels on BCM2837 to Gigabit Ethernet and other fast interfaces. BCM2711 integrated these interfaces, rendering this concept obsolete, but the project lived on as today's RP1.

“ I guess it's the reason that we built ourselves a chip team in the first place ”

"The MIPI bridge was the original idea for the RP1 chip, but we very quickly settled on the idea that actually, we should use something more standard like PCI Express," explains James. "So, that RP1 chip has gone through two prototype silicon steps (A and B) and this C-step - that is, the third iteration - is the production version. It's had fairly long gestation and I don't believe it's suffered for it: I think we've improved on it at each stage, and have had the time to make it all it could be."

## PCI Express - more speed on board

One of the things we've seen users request for Raspberry Pi over the years is eSATA connectors,

## What is a southbridge?

The southbridge in a traditional legacy PC is the chip that handles most of the medium-speed input/output (I/O) functions, such as USB, storage, networking, etc. In comparison, the northbridge provides the highest-speed interfaces: to SDRAM and PCI Express.

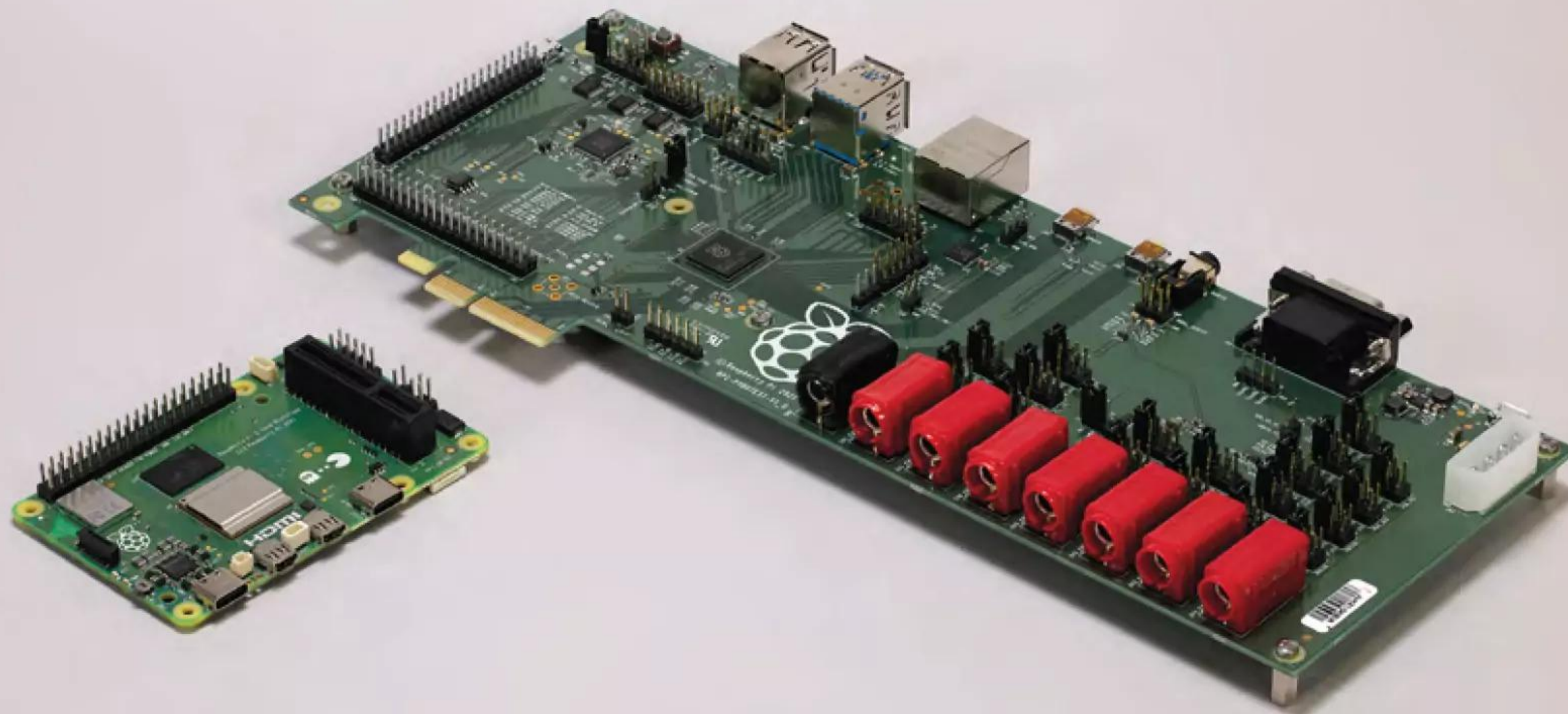

- ◀ The prototype board for RP1 is much bigger than the final product
- ▼ The old technique involves slowly heating up Raspberry Pi in an oven

so hopefully it will come as a pleasant surprise to most that Raspberry Pi 5 is jumping right past that to PCIe. “We’re seeing SATA as a legacy port these days,” James tells us.

The Raspberry Pi connector for PCIe looks a lot like the DSI and CSI ports, using a similar flat flexible cable to connect to a HAT. Why that, and not a standard connector, like M.2?

“M.2 is the smallest standard connector, but it’s still quite large,” says James. “Also, it has fairly chunky power requirements, hence the little custom connector there. We are doing a HAT that will allow you to put an M.2 on it though.”

When connected to the HAT, smaller devices in the M.2 form factor should fit neatly on top of the Raspberry Pi itself.

“The 2242 and 2230 form factors [Ed note: 42 and 30mm long respectively] should fit fine,” James says. “For longer devices, currently, I’ve got some mounting holes at the edge of the board. We may be able to build some kind of bracket that fits onto those holes and restrains the device, but we’re still working on that one.”

Apart from the obvious opportunity to add NVMe storage, other uses for the PCIe port include Ethernet bridges, SATA bridges, and even a TPU for machine learning applications.

### PMIC - pushing USB C to the limit

The ‘fairly chunky power requirements’ that James mentioned are only possible thanks to a new PMIC (power management integrated circuit) that’s been developed specifically for Raspberry Pi 5.

“This Dialog (now Renesas) PMIC is a real beast,” James says. “It’s a brilliant bit of

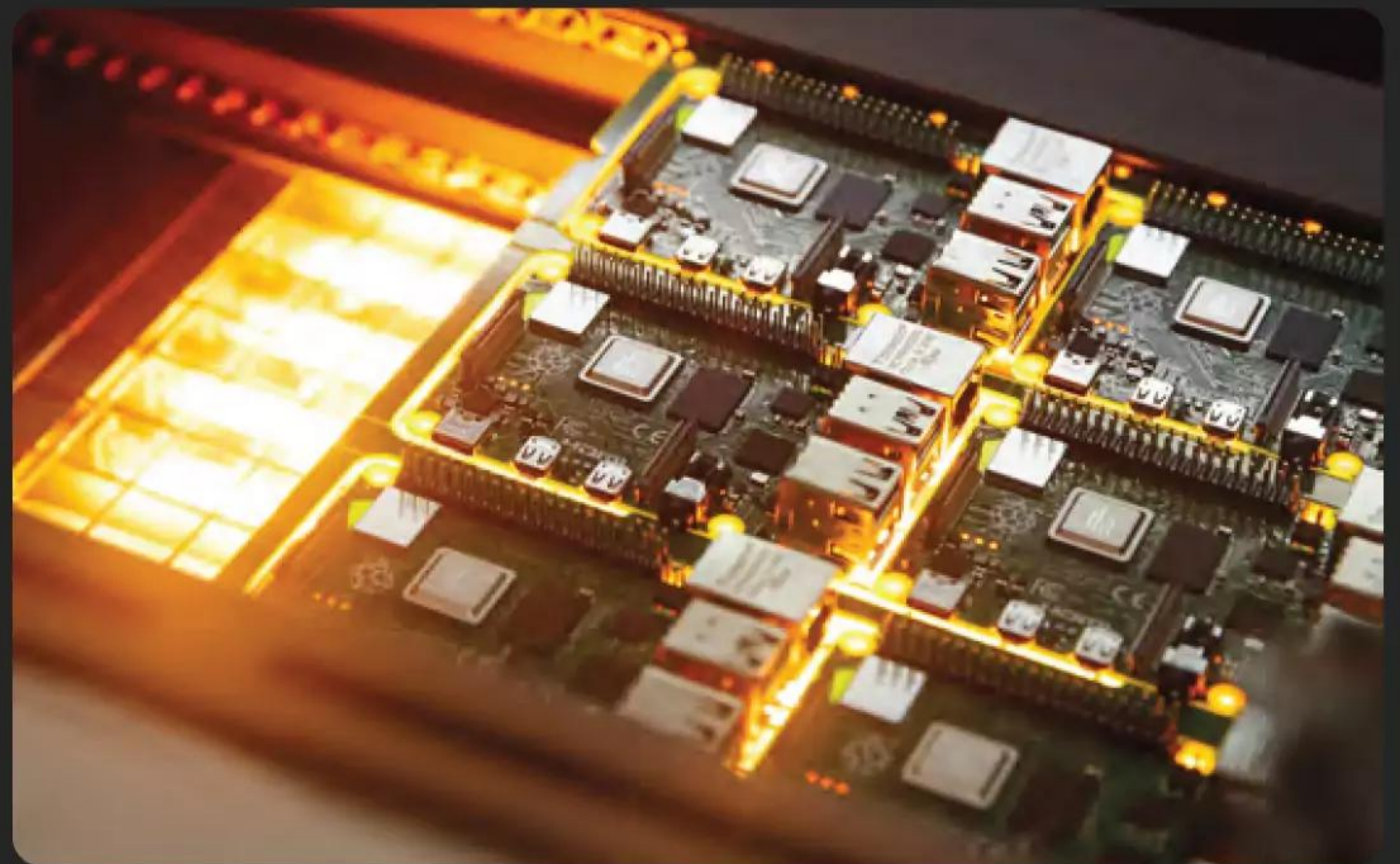

## New construction techniques

Previously, Raspberry Pi boards were manufactured using techniques called wave, or selective, soldering. These involve carefully splashing molten solder onto the board. A new technique is being used for Raspberry Pi 5 called intrusive reflow. “Your pick and place machine now picks and places the big connectors as well,” James explains. “What you do is you put solder paste on the bottom side, then they put the components on, put it through the oven, and they will get soldered and stuck. And then the same for the other side... they put paste over the holes, and then the pick and place machine puts these in and then, when the oven comes in, it will flow down inside the holes and form a strong joint.” The connectors had to be modified to withstand the heat of the oven, but it results in a yield and reliability improvement for Raspberry Pi, and, as James says: “it just looks better.”

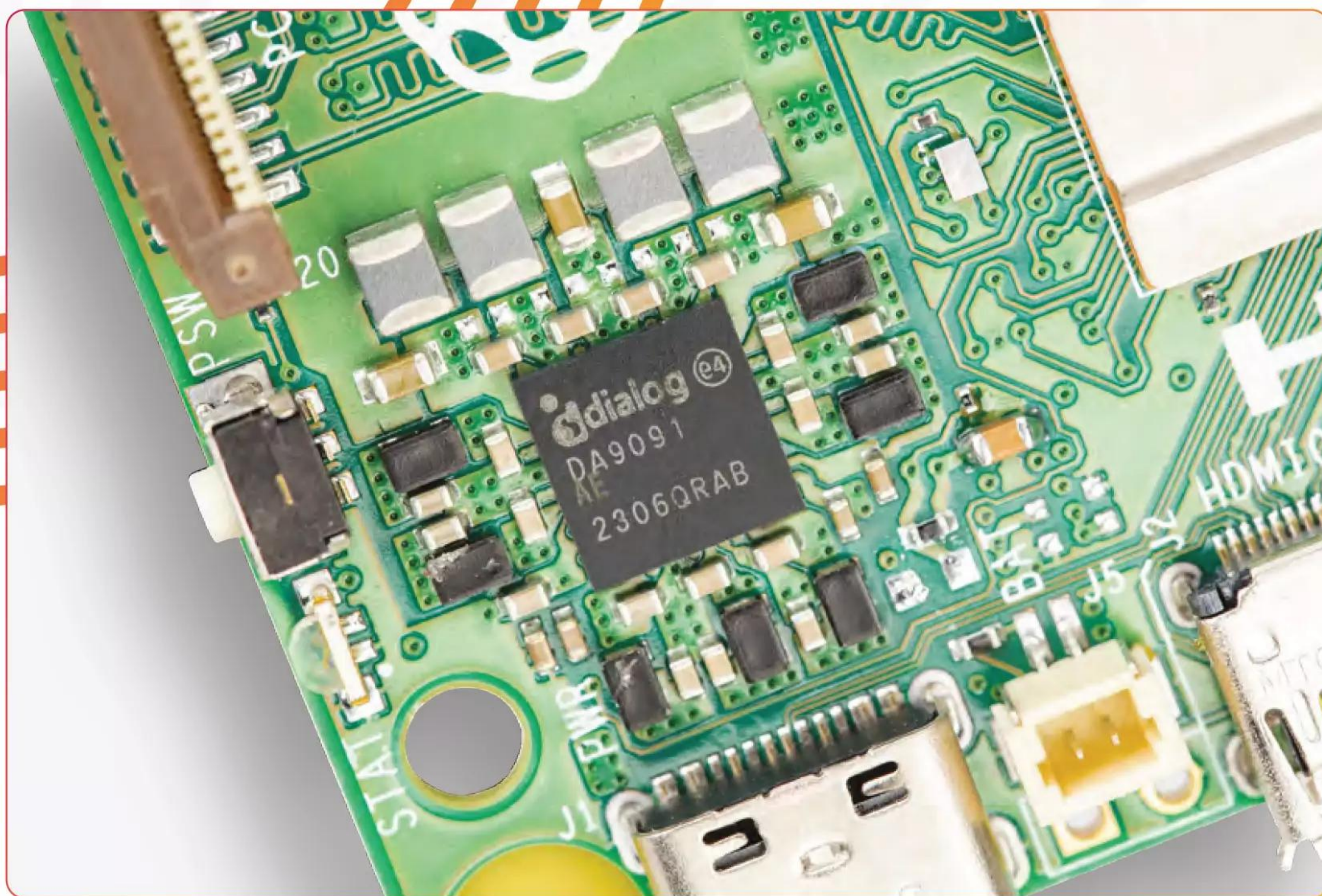

► This set of chips was custom designed for Raspberry Pi 5, allowing for everything to be properly powered

engineering. I spec'd it to add everything that I wanted on there – despite not being really super-secure that we'd be able to deliver everything – and, of course, so it fitted on the board. Actually, working with Dialog, we managed to just squeeze it all into the space available at the right kind of cost. It's just been a lovely bit of engineering and it looks really neat and tidy... It even has supply voltage and current sensing. So, you can get on the fly voltages and current readings for each rail which is useful, and it's also got a real-time clock on there.”

And because of this custom work, a feature that's been much desired since the launch of the original product in 2012 has finally been added to Raspberry Pi 5: a power button. James has wanted to add a button to a Raspberry Pi for a long time. “The PMIC reads the state of the power button, and handles ‘hard’ startups and shutdowns, itself,” James explains to us. “For ‘soft’ startups and shutdowns, it sends the button state to the main processor, which manages graceful transitions in and out of shutdown.

### Powered up

The souped-up PMIC allows for the gruntier (James' wording) main SoC to consume more power, and it does this in tandem with a new USB power supply.

“We'll be launching a new Raspberry Pi USB power supply, which can supply five volts at five amps. We're using the USB-C connector at

its maximum current, rather than going to a higher voltage.”

“Both the PMIC and the power supply support the USB Power Delivery (USB PD) standard. With USB PD there's a little serial interface running over the power cable. You talk to the power supply, it starts off at five volts, but then you ask it: ‘what voltages do you support?’. And it says: ‘I support all these voltages.’ Usually it's five, nine, 15, 20 volts if you've got a PC one. We could have just used a standard PD supply,

“ We decided to do something a little bit non-standard, which is what we often do in search of performance ”

get nine volts at three amps, but then you have to do the voltage conversion on the board. That costs you area, it costs you silicon, it costs you efficiency. So, we decided to do something a little bit non-standard, which is what we often do in search of performance, and create a five-volt, five-amp profile for our power supply. That means you don't need all that conversion, but it can still support the board, and if you're using the new supply we can support extra USB current downstream compared to Raspberry Pi 4. Or more HAT current.”

## Real time clock

For the first time ever, Raspberry Pi will come with an RTC, a real time clock, which allows for accurate timekeeping, even when it's switched off. “There's a little tiny 32kHz crystal, and we've got a little rechargeable battery that plugs into the socket there,” James said, when we asked about it. With the battery installed, he reckons it will last for six months without needing to be powered back on.

# Documenting Raspberry Pi 5

Writing great documentation for every level is necessary, argues Alasdair Allan



**BIO**  
Alasdair Allan

HEAD OF  
DOCUMENTATION

Alasdair is a long-time tech writer and enthusiast, and appreciates it when people compliment the Raspberry Pi documentation.

## Task lead vs feature lead

Two of the main ways the docs are split up is based on whether they need to be task lead or featured lead.

Feature lead tends to involve the lower-level functions – giving information on how, e.g., SPI or i2c work and how you can access them. Task lead tends to be a bit meatier, giving you all the information you need from the lower levels up to create, say, a web server that displays sensor readings.

**W**hen Raspberry Pi Pico was released, people were quick to praise the in-depth official documentation found at [magpi.cc/docs](https://magpi.cc/docs).

Writing the docs is a collaborative effort with the engineering and comms team headed up by Alasdair Allan, Head of Documentation. We asked him how they were written.

“How they’re written really depends on what sort of product we’re releasing,” Alasdair says. “For instance, Raspberry Pi 5 is the culmination of several different projects. It has our own silicon on-board, it’s not the main CPU, that’s a piece of silicon from Broadcom. But Raspberry Pi 5 has got our own RP1 chip on-board, and that’s a piece of silicon that talks to all of the on-board peripherals. It talks to I2C, it talks to SPI, it talks to the USB bus, the Ethernet, the cameras, the displays; it’s where all of the peripherals hook into the CPU. So we need a piece of documentation that lets you write kernel drivers, and will allow you to port an operating system to the new Raspberry Pi 5. The documentation needs to be a thorough register level deep-dive, and that means that it’s going to be collaborative effort. Because nobody can hold the whole thing in their head at once.”

At the time we spoke to Alasdair, the peripherals document for RP1 was roughly 1200 pages, but he was hoping to cut that down.

“Beyond that, there’s another strand of work for Raspberry Pi 5, which is the documentation around the board itself,” Alasdair continues. “Raspberry Pi 5 has a number of things that have not been made available before, [such as] PCIe, and there’s other things that are Raspberry Pi 5-specific, and that’s the only documentation I haven’t started writing yet. There’s plenty of time for that, and we’re still waiting for software to settle before launch.”

## Window of opportunity

Writing the docs isn’t just about getting the information down – the kind of people looking for

that level of info need to be able to understand it, and this is a big part of the philosophy for the docs.

“Documentation is about letting people accomplish a task without making them learn more than they have to do,” Alasdair explains. “What your user wants to do is the thing that they want to do. They don’t care if they accomplish that in a specific computing language, using a specific technology, or specific piece of hardware, they simply want to do the thing they need to do, whether it’s measure temperature, or run a web server, or spin up a file server, [etc.] The task they want to accomplish is the important thing to them. And the documentation and the software under it, and the hardware underneath that, needs to make that as simple as possible.”

“ Documentation is about letting people accomplish a task without making them learn more than they have to do ”

For the kind of user knowledge these sections are written for, Alasdair treats these levels as a window.

“ I don’t believe anyone can hold all that in their heads any more. [It’s all about levels of abstraction], you work at the top end, or in the middle, or at the bottom, and the full stack. What you actually work on is a moving window that looks out onto a stack of technology that spans all the way from silicon to high-level languages and protocols. There’s no way that windows reaches all the way to either end. Some people have wider windows, and some have narrow windows. And that’s fine. But nobody can hold the whole thing in their hands.”

# SUBSCRIBE TODAY FOR JUST £10

Get 3 issues + FREE Pico W



GET RASPBERRY PI 5 **FIRST!**  
**Priority Boarding**  
PAGE 8



## Subscriber Benefits

- ▶ **FREE Delivery**  
Get it fast and for FREE
- ▶ **Exclusive Offers**  
Great gifts, offers, and discounts
- ▶ **Great Savings**  
Save up to 23% compared to stores

## Subscribe for £10

- ▶ Free Pico W
- ▶ 3 issues of The MagPi
- ▶ Free delivery to your door
- ▶ £10 (UK only)

## Subscribe for 6 Months

- ▶ Free Pico W
  - ▶ 6 issues of The MagPi
  - ▶ Free delivery to your door
- |          |                     |
|----------|---------------------|
| £30 (UK) | \$43 (USA)          |
| €43 (EU) | £45 (Rest of World) |

📞 Subscribe by phone: **01293 312193**

📧 Subscribe online: **magpi.cc/subscribe**

✉ Email: **magpi@subscriptionhelpline.co.uk**

Subscribe for £10 is a UK-only offer. The subscription will renew at £15 every three months unless cancelled. A free Pico W is included with a 6-month subscription in USA, Europe and Rest of World.

**SUBSCRIBE TODAY AND GET A**

# **FREE** Raspberry Pi Pico W

Subscribe in print today and get a **FREE** development board

- ▶ A brand new RP2040-based Raspberry Pi Pico W development board
- ▶ Learn to code with electronics and build your own projects
- ▶ Make your own home automation projects, handheld consoles, tiny robots, and much, much more

WORTH  
**\$6**



This is a limited offer. Not included with renewals. Offer subject to change or withdrawal at any time.

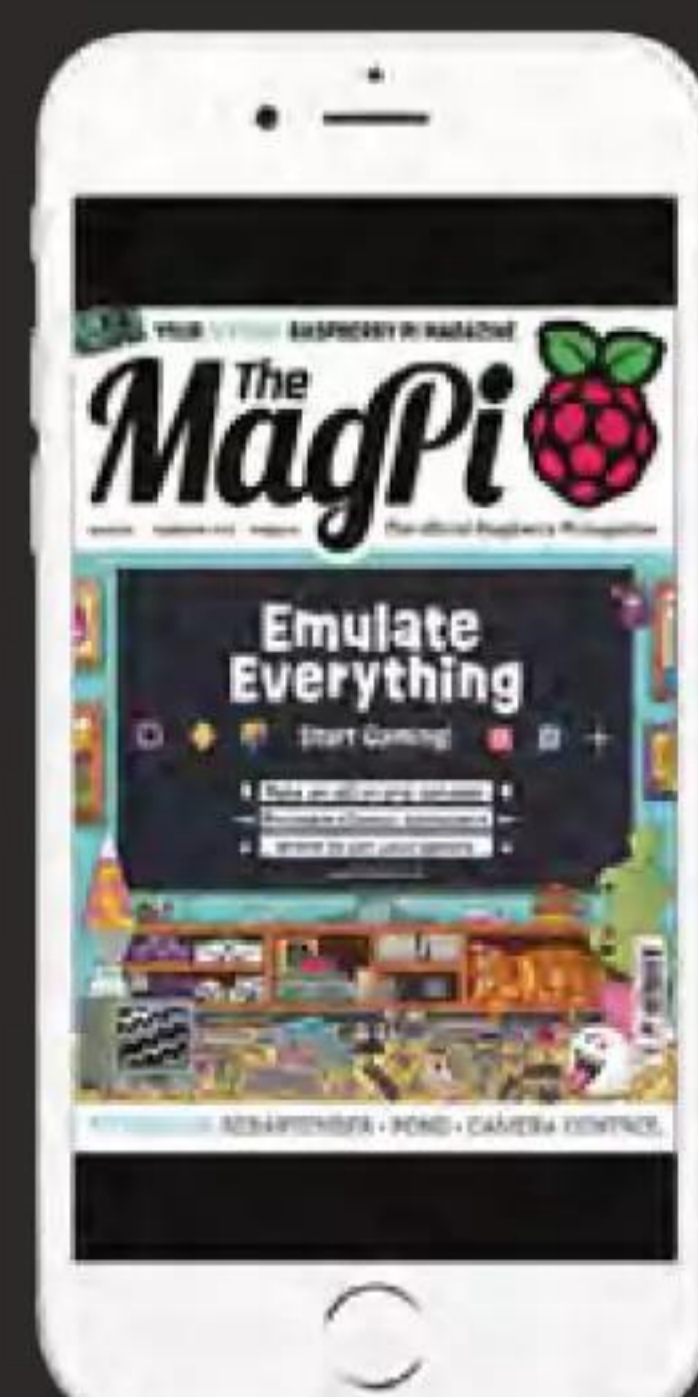

 Buy now: [magpi.cc/subscribe](https://magpi.cc/subscribe)

**SUBSCRIBE**  
on app stores

From **£2.29**

 Available on the  
**App Store**

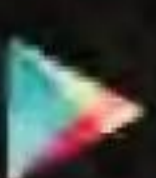
GET IT ON  
 **Google Play**

# Bristol Braille Canute 360

Braille readers bring literacy to non- and partially sighted readers. **Rosie Hattersley** hears about a breakthrough Raspberry Pi version



**Ed Rogers**

Bristol Braille MD Ed Rogers has used Raspberry Pi professionally and for his own interest since it first launched, and loves the community and support it provides.

[bristolbraille.org](http://bristolbraille.org)

**S**creen fatigue is all too real for millions of smartphone and laptop info-seekers, but the details we get to read oh-so-casually are something most of us take for granted. Not so for blind and partially sighted readers. Text-to-speech engines do a great job of narrating on-screen information, but it's no substitute for being able to read what you wish to at your own pace.

Community interest organisation Bristol Braille set about changing this with its Canute 360 multi-line reader which has a Raspberry Pi at its heart. This Raspberry Pi Zero-based device is the world's first multi-line Braille reader and is capable of generating whole paragraphs of text at a time – a huge leap forward compared to the few words at a time Braille users are often accustomed to. Canute has 40 cells on each of its nine lines of text. It can read Braille Ready Files and Portable Embossed Files, so the world of reading now spans texts from Bookshare, the RNIB Library, and any other Braille library in the world. Excitingly, it can also open up the world of gaming.

### Keeping it local

Founder and MD of Bristol Braille Technology Ed Rogers has been working on “refreshable Braille



technology” since 2008 and co-invented the Canute multiline Braille display. He is also a co-founder and trustee of the Braille Foundation, a community of more than 1500 people who help each other with projects to promote Braille use. Ed drew on this community's expertise when designing the Canute 360 to ensure it would meet their needs and expectations. Having closely followed Raspberry Pi's success for many years, he was convinced from the outset that it would be the ideal component for the embryonic Braille reader. “We didn't want to distract ourselves by



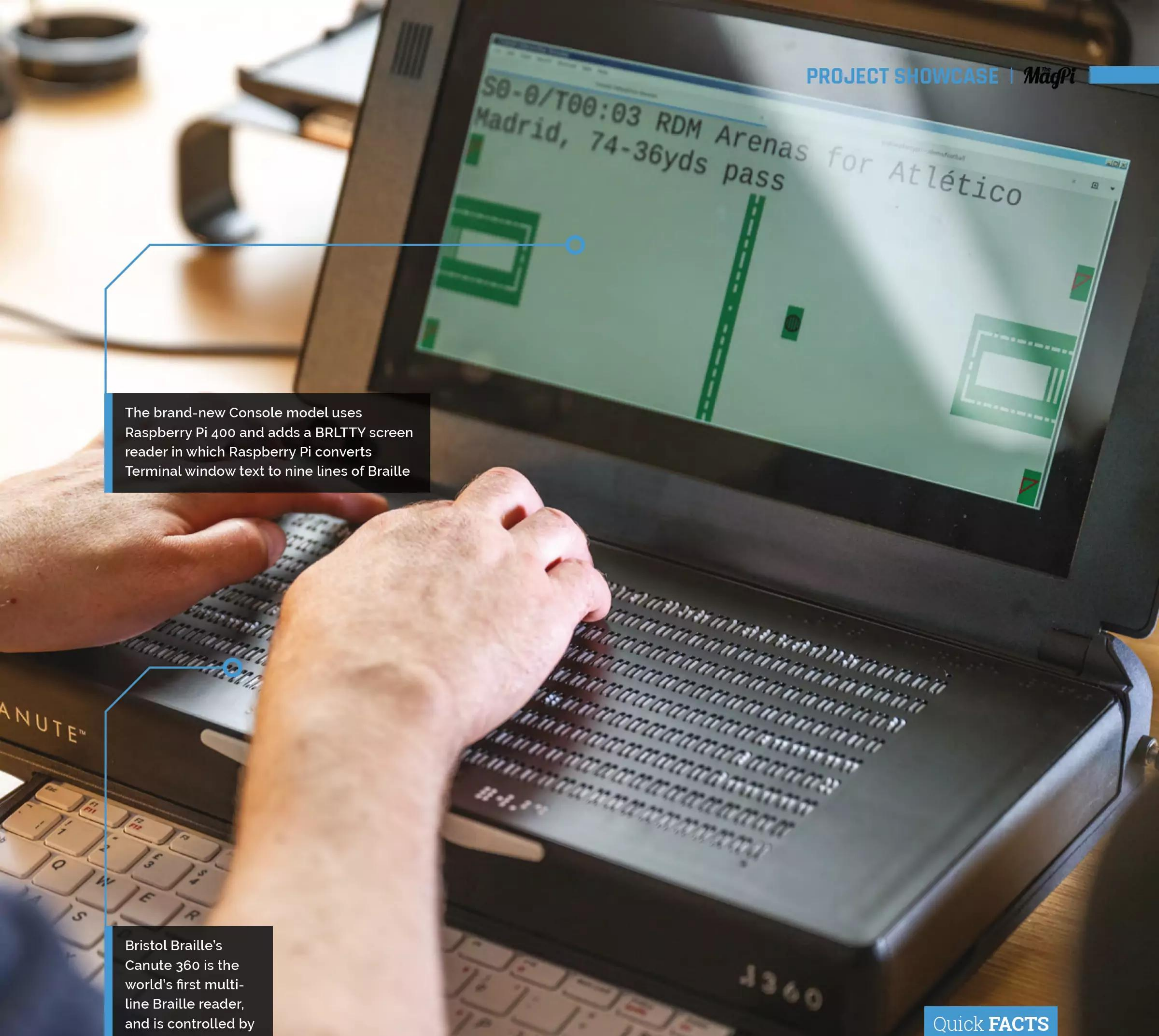

The brand-new Console model uses Raspberry Pi 400 and adds a BRLTTY screen reader in which Raspberry Pi converts Terminal window text to nine lines of Braille

Bristol Braille's Canute 360 is the world's first multi-line Braille reader, and is controlled by Raspberry Pi Zero

▶ The large display and coloured text massively improve the legibility

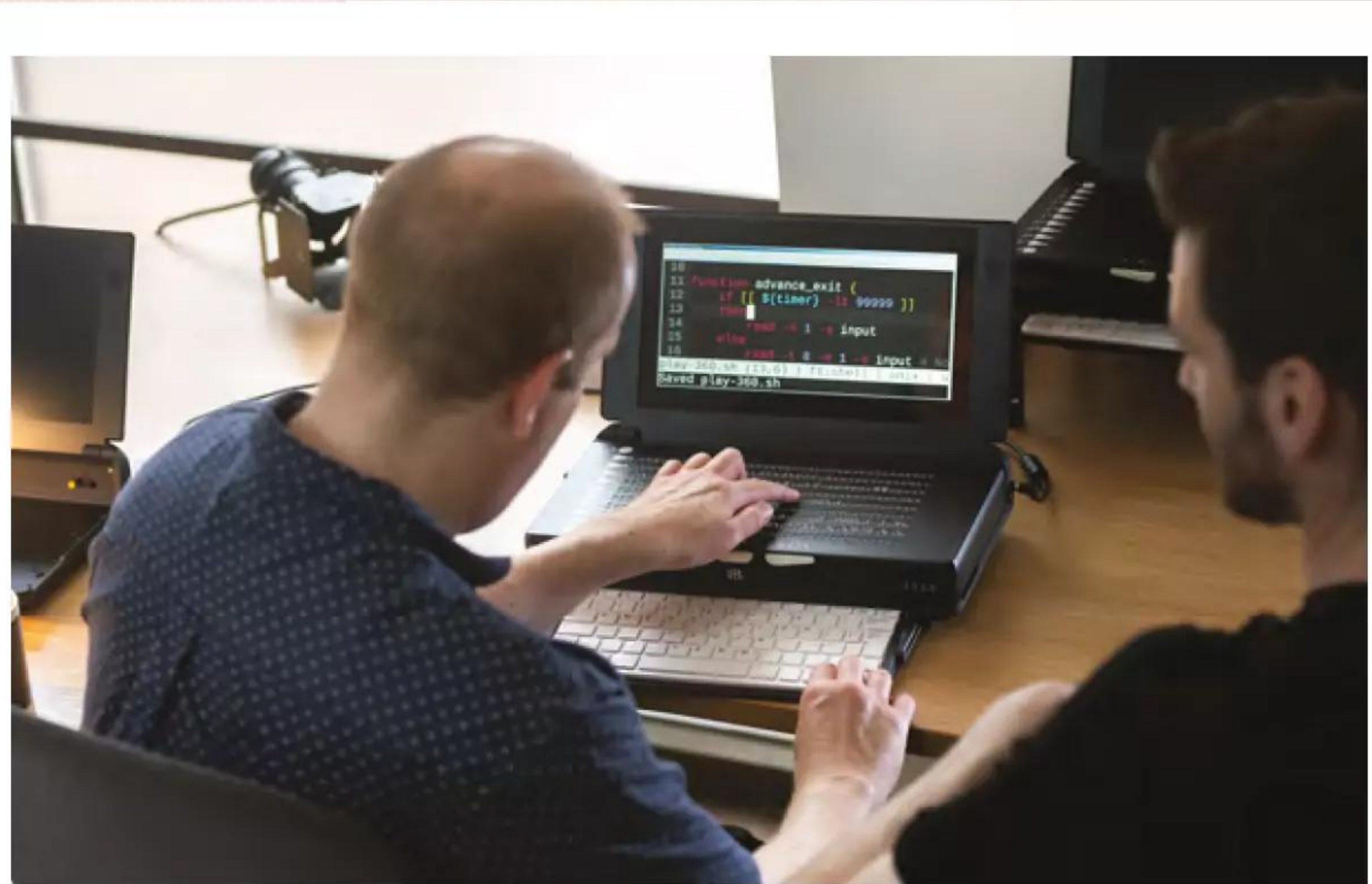

**Quick FACTS**

- ▶ The Canute 360 contains 360 Braille dots
- ▶ It's the size of a coffee table book
- ▶ It can read any Braille-ready text file
- ▶ The new Console model has a built-in high-contrast screen
- ▶ So, both Braille and low-vision reading are supported



reinventing the wheel, or having to support our own OS,” so the dedicated OS and thriving Raspberry Pi community were vital factors.

Bristol Braille started with a standalone, “functional” book-reading prototype, says Ed, and the 14 major revisions over an eight-year development cycle each involved Raspberry Pi and Python. The folks at Raspberry Pi loved the concept, and Ed says individuals “bent over backwards” in a bid to ensure Canute made it to market. This is refreshing for a small company working in a supply chain that likes scale. While some components for the Canute are made in places such as China and India, the circuit boards are made by Philtronics in Wales, and the final build is done in-house in Bristol and Exeter. “By taking advantage of the proximity, we are able to be much more hands-on,” says Ed.

Ed describes Raspberry Pi Zero as Canute’s ‘brains’. It runs Raspberry Pi OS, along with the Braille custom user interface ([magpi.cc/canuteui](http://magpi.cc/canuteui)). The interface was Bristol Braille’s biggest design hurdle, especially since the final product needed to be relatively affordable. Although it has a £2000 price tag, many are destined for libraries and educational institutes and, thus, will have multiple users.

▲ The Canute Console Braille reader, based on Raspberry Pi, produces musical notation, charts, graphs, tables, and diagrams



▲ Bristol Braille took their Braille readers on tour to garner feedback to ensure the new device would match everyone’s needs



Raspberry Pi Zero is connected to media ports on the main circuit board, and is able to read the BRF (Braille Ready Files), interpret them as Braille, and send them to an Atmel chip on the main board to convert into dot patterns. Each Braille cell is made up of six dots which can either be up or down. There is virtually no margin for error, and a stuck dot can change the entire meaning of a word.

### Incredible touch

Bristol Braille's Canute 360 has been enthusiastically embraced by the Brailist community, with several hundred already sold. This summer, the team embarked on a roadshow demonstrating the 360 and its successor, the Canute Console. This is based around Raspberry Pi 400, meaning greater processing power as well as an integrated keyboard. A hardware add-on that

▲ The Canute 360 electronic Braille reader has ports including USB, HDMI, and SD card

“ The circuit boards are made by Philtronics in Wales, and the final build done in-house in Bristol and Exeter ”

includes a Canute 360, it adds a BRLTTY screen-reader. Ed says the Console enables them to do “far more exciting things with tactile graphics, using Raspberry Pi 400 to interpret sports matches as tactile animated pitches [and] to draw maps of cities in a top-down GTA 2 fashion.”

This recently launched model has a technical graphics focus, and is aimed at computer science students and those familiar with using Linux or willing to learn it. Every pre-existing multi-line Linux terminal application shows up in digital Braille for the first time. The new device has generated much excitement, with the first pre-orders currently being delivered. Watch the demo video at [magpi.cc/canuteconsole](https://magpi.cc/canuteconsole) showing a football match replay. 

## Brilliant Braille!



**01** The Canute 360 comes pre-assembled, but there are GitHub setup instructions for the user interface at [magpi.cc/canutejit](https://magpi.cc/canutejit) so you can emulate it.



**02** The Canute and Console readers can use transcription software, such as Duxbury DBT or Braille Blaster, on any digital text file. This can be imported via USB and read by either reader.

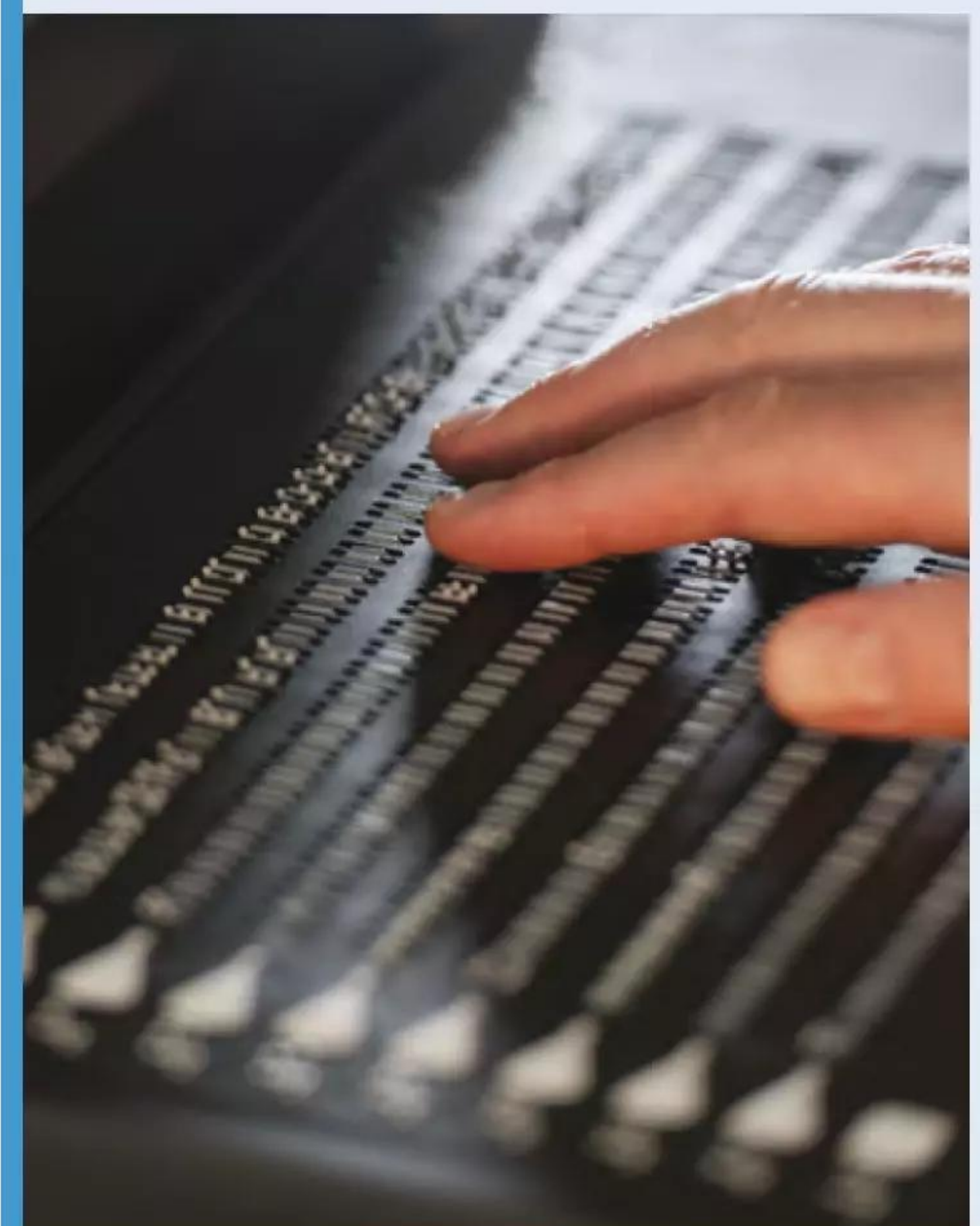

**03** An Atmel chip on the main circuit board communicates with Raspberry Pi and converts text files into nine lines of Braille text.

# Giant Dot Matrix Printer



You may think you know what a dot matrix printer looks like. Well, read on and be dumbstruck! **Nicola King** gets on board

MAKER

## Ryder Damen

Ryder is a creative technologist who likes to use technology to bring strange ideas to life. With a biomedical engineering/science/aviation background, he hangs around at the intersection of technology and art.

[magpi.cc/ryderyt](http://magpi.cc/ryderyt)

**W**alking through his hometown one day, observing some people painting lines on the road with a spray machine, Ryder Damen had a brain wave. “I wondered how they did different types of text and from there thought of the idea that, with a bunch of nozzles, I could pretty much spray anything I want,” he explains.

What if, say, he used water, to avoid any permanent damage, and what if he used his truck as the means of dispersing that water on the ground, forming text as he drove around, effectively creating one giant dot matrix printer on wheels?

### An impermanent print

Armed with, amongst other things, some solenoid valves, wood to attach the valves to his truck, a good length of hosing, speaker wire, hose splitters, and a bilge pump, Ryder set to work.

“The ‘printer’ runs off 12V direct from the car’s cigarette lighter,” he explains. “There’s a Raspberry Pi 4 that runs a web server that accepts input text, an input speed and font and, from that, turns the text into a picture and iterates over it left-to-right to create a bit of a map. From that map, it then determines which solenoid valve (1–12) to open or close, at a particular time.”



### Warning! Legal & Car Safety

Recreating this project in the UK is inadvisable. Attaching a car accessory may invalidate your insurance, and spraying water onto the road may be considered a hazard.

[magpi.cc/drivesafely](http://magpi.cc/drivesafely)

► From above, you can clearly read the words that have been input to print



▲ A view of the inner workings, including a Raspberry Pi 4 and relay board

Raspberry Pi’s GPIO pins are used to open and close valves via a relay board to manage the higher voltage. It also controls a windshield washer pump that turns on just before printing and just after completion to pressurise the lines. The water is then pumped out of a large bucket, into the lines, and out through the solenoid valves onto the road.

Writing the required Python code himself ([magpi.cc/giantdotmatrix](http://magpi.cc/giantdotmatrix)), Ryder didn’t find it the most challenging part of the build. “Code is my talent; that part comes easy to me. Wiring, debugging wiring, and everything electrical on the other hand, I struggle with and it takes me a while.”

The solenoid valves are situated about 1.5 ft above the ground on a trailer hitch, but this height will vary depending on the vehicle. In terms of the amount of water utilised, Ryder says it’s “surprisingly efficient. I can usually write messages for about 10–15 minutes before it runs out.”

Interestingly, he claims that you can drive any speed, “as long as it’s a constant speed, and you input it into the web server before you drive. We tested it up to about 20 km/h, and I’m hoping to get the speed way up in version two.”

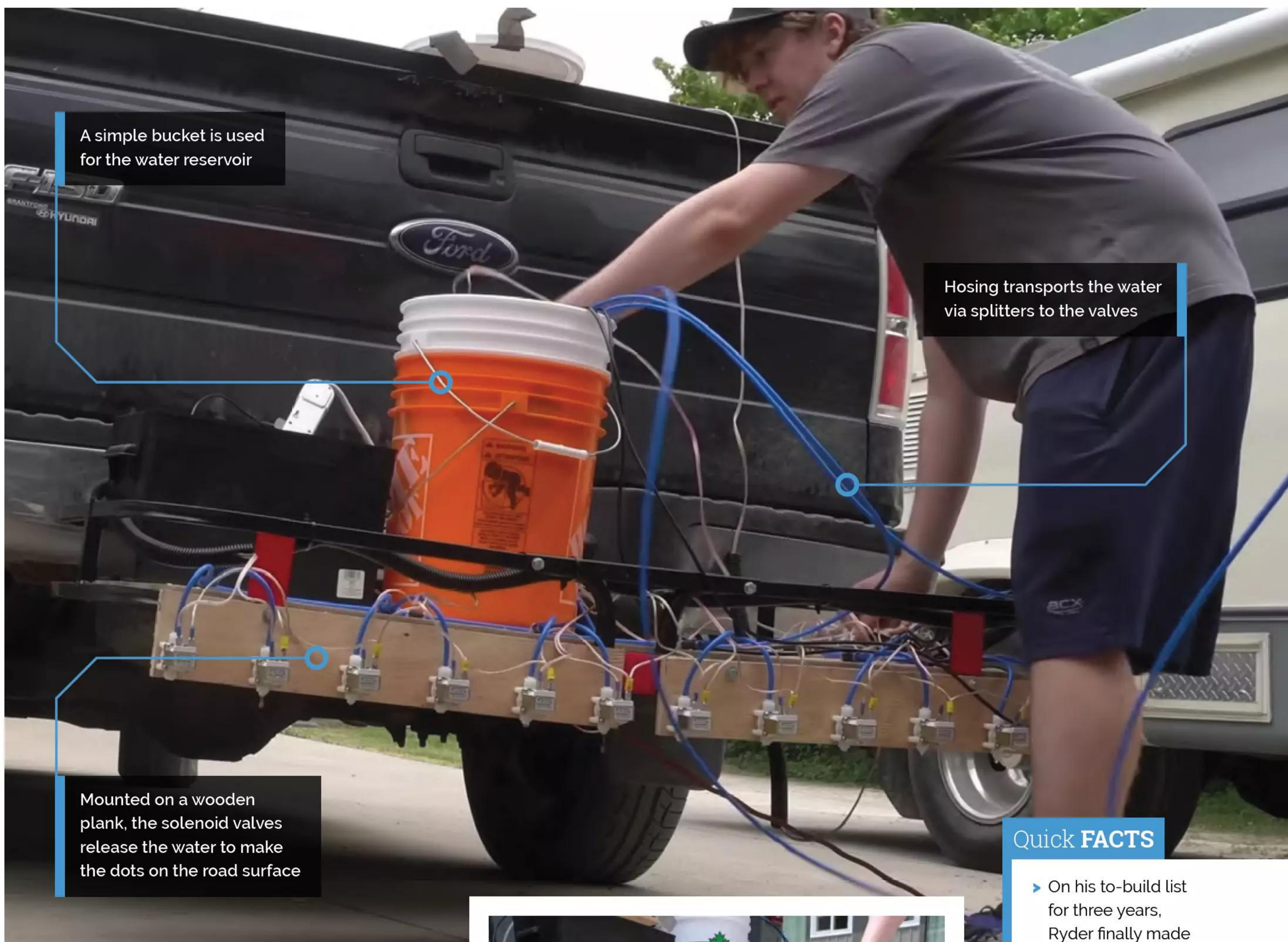
**Quick FACTS**

- ▶ On his to-build list for three years, Ryder finally made it this spring
- ▶ It took around three weekends of full-time work...
- ▶ ...including building, testing, and filming
- ▶ It cost him around Can\$500 to build
- ▶ The priciest parts were the solenoid valves and trailer frame

“ My neighbours have seen me doing a lot weirder projects, so they’re used to it ”

**Truckloads of inspiration**

Ryder describes this make as being of “moderate difficulty”, but would encourage anyone to have a go, “maybe trying a project with one pump and one solenoid (like a sprinkler).”

Looking to make new versions of the printer, he has ordered a considerably more powerful pump in the hope it will improve the aesthetic of the printing. “I’m even looking at doing colour in some way that I’ve yet to figure out – I don’t want to have to clean up a mess or leave anything behind.”

While feedback from the maker community has been wholeheartedly positive, some locals were a little bemused. “My neighbours have seen me



▲ Testing the solenoid valves in turn; each needs to dispense the correct amount of water

doing a lot weirder projects, so they’re used to it, but I did get some weird looks from people on the street, as the machine itself – with its wires, hoses, and dripping water – looks a bit strange.”

Ryder confirms that we can expect more offbeat Raspberry Pi-linked projects from him, but “I’m keeping them secret until I actually build them.” Watch this space... 

# DispatchPi

Olivier Simard-Hanley found a picture-perfect way of keeping in touch with his fiancée, as **David Crookes** discovers



**MAKER** **Olivier Simard-Hanley**

Olivier is a data scientist from Montreal, Quebec, passionate about AI strategies applied to language. He entered the field after a stint in the arts sector and a degree in classical music.

[magpi.cc/dispatchpi](http://magpi.cc/dispatchpi)

**W**hen Olivier Simard-Hanley was faced with spending many months apart from his fiancée, he needed to find a simple way of keeping in touch. Trouble is, the task was always going to be trickier than it sounds because his fiancée was moving to a remote Inuit community in northern Quebec to work as a nurse for a year while Olivier was finishing his master's in technology in Montreal.

"Puvirnitug, in the Nunavik region, has poor internet connectivity and no cellphone coverage," Oliver explains. "I also anticipated that aligning our schedules would be challenging due to the demands of her job and my full-time program. I wanted to be able to swap pictures of our daily lives in a fun and interactive way, even though we were temporarily 1600 kilometres apart."

### She's the one

The answer, he figured, would be a system that made image-sharing simple, so he came up with

the concept for a pair of custom-made digital photo frames that made use of e-ink displays. Although the couple would be limited to sharing black-and-white images, this approach had many benefits, notably low power consumption and simplicity.

"It had to be energy-efficient because Nunavik is mostly powered by diesel that's brought in by boat," Olivier says. "It also needed to require very little bandwidth as my fiancée's internet would probably come from an unstable satellite link. The project had to be easy to use too and required, at most, a couple of seconds to share a picture, much like texting or writing an email. And I didn't want my fiancée to fuss with a complicated app after completing a night shift and on-call duty."

With that in mind, Olivier began to plan. A frame would consist of a Raspberry Pi Zero W computer and a 7.5-inch Waveshare e-ink display,

▼ Attaching Raspberry Pi to the picture frame was difficult. Olivier used a plastic case and lots of tape in the end

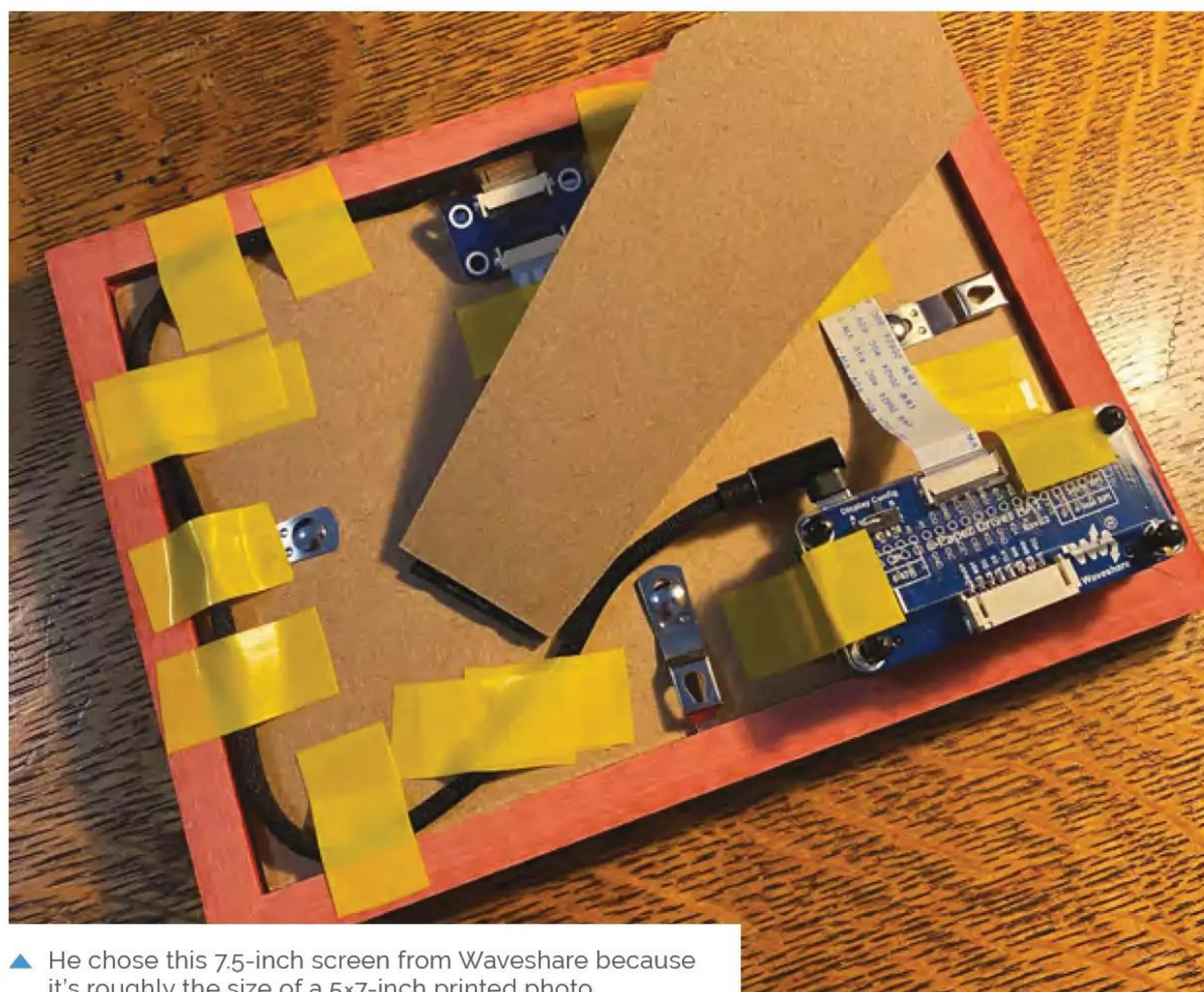

▲ He chose this 7.5-inch screen from Waveshare because it's roughly the size of a 5x7-inch printed photo

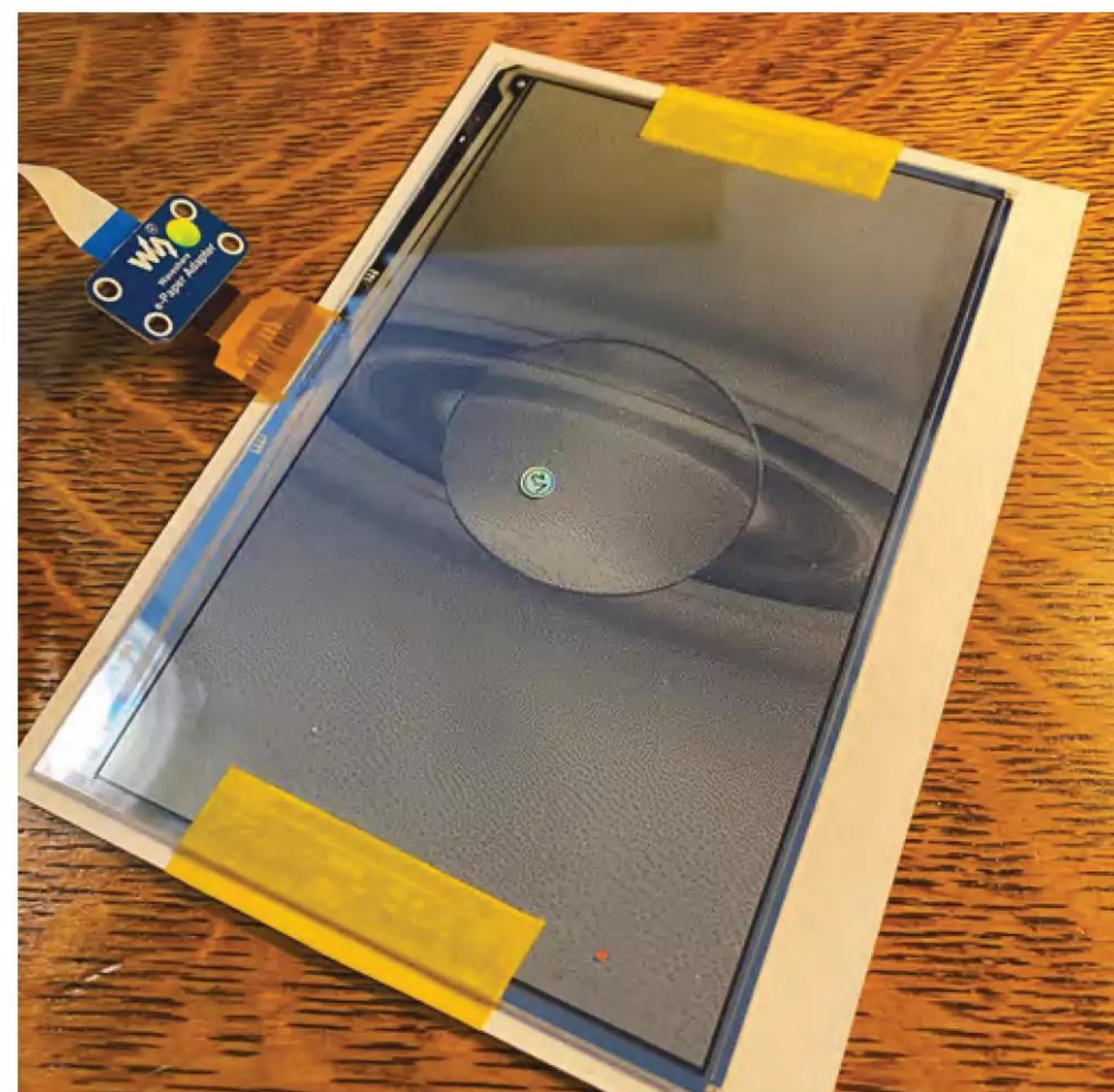

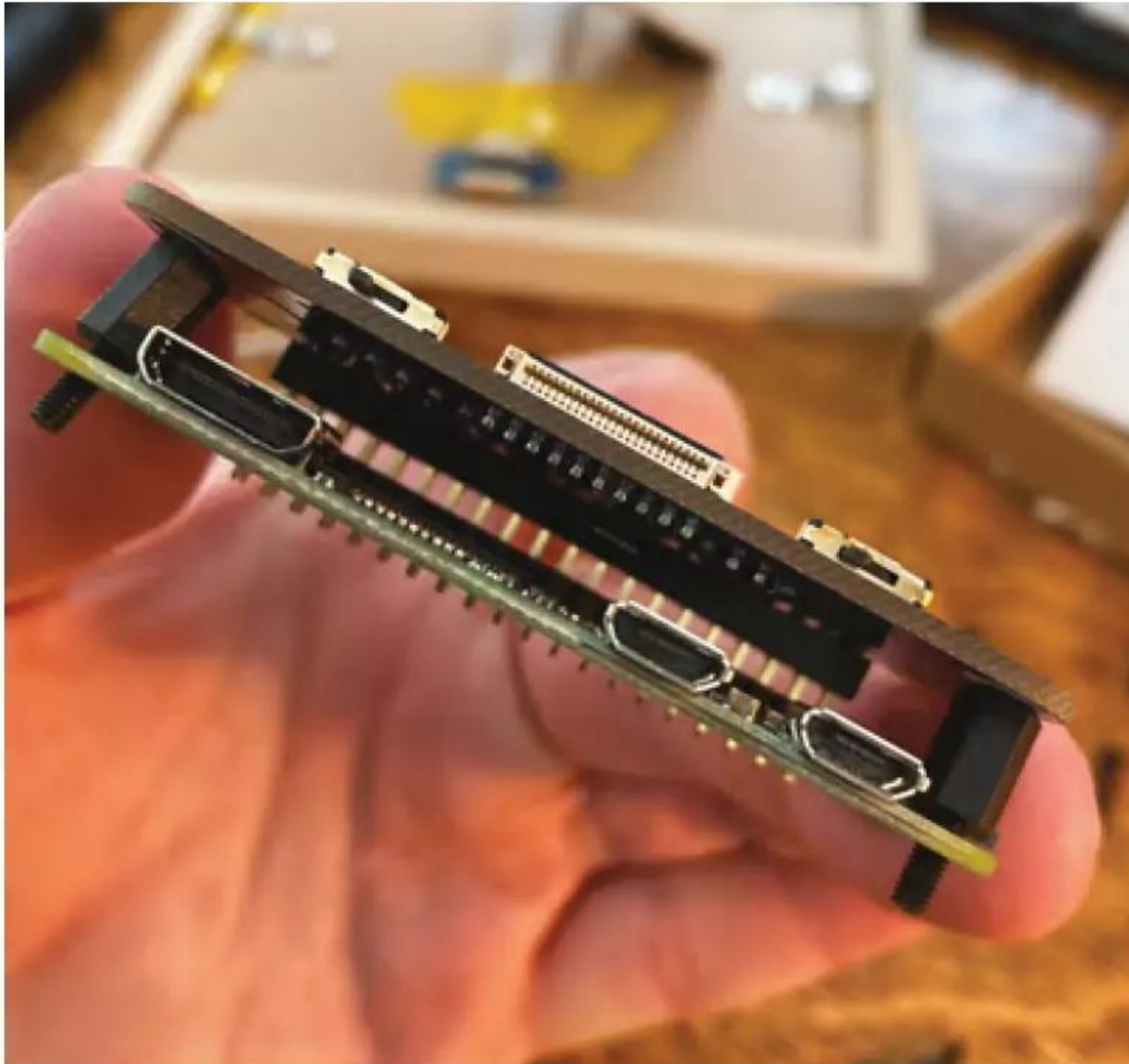

▲ Olivier has been delighted by the response to his project on Reddit and GitHub. He has documented his build and written a tutorial

and the idea was to allow images to be emailed to a Google inbox with a program written to make use of them at regular intervals.

“I like e-ink technology,” Olivier continues. “Each pixel on an e-ink display hosts tiny pigments that are physically jolted around by an electrical charge and they stay in place even if

“ My fiancée was delighted when I gave it to her as a Christmas present ”

power is disconnected, which means the screen will continue displaying the same image until it is refreshed.”

### Life through a lens

Olivier thought the project would be straightforward. It wasn't. “I didn't think writing a script to automatically read attachments from a Gmail inbox would prove so tricky,” he laments. “I definitely underestimated this part of the project because it took me a long time to figure out how a Flash web application written in Python can use and refresh Google authentication tokens.”

He used the industry-standard protocol for authorisation, OAuth 2.0, instead of a simpler email-password login strategy. “It was a way of future-proofing the project because it's a robust



Allowing overlaid text provides context and ensures recipients understand what images are showing. “A photo of pancakes in black and white at 800 × 480 pixel resolution isn't always self-explanatory,” Olivier says

Photos are emailed to a Gmail inbox. It helps that most email clients persistently reattempt to send messages stuck in the inbox in case of internet connectivity problems

Olivier likes the old-school rasterised look caused by the low resolution of e-ink displays

### Quick FACTS

- ▶ The screen displays images sent by email
- ▶ Raspberry Pi pulls images from a fixed URL
- ▶ Senders use a custom iPhone shortcut
- ▶ Shortcuts are not necessary to replicate the project
- ▶ It uses the Gmail API and Google Cloud Run

and secure protocol directly supported by Google,” he says. He also added the ability to include custom messages which would be overlaid on to the images. “It was hard to speak on the phone, and internet audio calls were patchy, so I wanted a way to explain the context of each photo,” he adds.

For greater user-friendliness, Olivier created iPhone shortcuts too. “It simplified the process of selecting and emailing a recent image to the dedicated Gmail inbox,” Olivier says. “A click is enough to launch the whole process.” This addition proved an elegant way of stitching together all of the application's parts and it proved effective.

“My fiancée was delighted when I gave it to her as a Christmas present,” Oliver recalls. “We spent a year swapping pictures to and fro, and I was able to discover the north through her lens as well before flying up to visit her.” **M**

# Zelda Guardian security camera

Adopting a stray dog prompted a kind-hearted coder to come up with a Raspberry Pi way of keeping an eye on him. Cute huh? By **Rosie Hattersley**



MAKER

## Naomi Pentrel

Software engineer Naomi has an MSc in Computer Science and is an enthusiast for Python and MongoDB.

[magpi.cc/guardiangit](http://magpi.cc/guardiangit)

**W**hen it comes to life goals, Oxford master's graduate Naomi Pentrel is doing pretty well. Along with an impressive roster of academic achievements and professional roles as a software engineer at the likes of Google, Microsoft, and Bloomberg, she is a regular public speaker, enthusing about MongoDB and other database possibilities. The savvy coder has a very important housemate to keep her in check: the toy poodle, Ernie, who she and her partner took under their wing two years ago. Although the Netherlands-based couple largely work from home, when they're away they like to check in on their beloved Ernie: hence creating a Raspberry Pi 4-based Zelda Guardian so they can see what he's up to. Aw, cute!

## What a character!

Although Naomi and her partner can't bear to be parted from their poodle, when they are they generally set up an old phone through which they can watch him. However, "our living room is connected to a kitchen and there is no way to set up a phone camera to capture the entire room. If Ernie moves out of view of the camera, we can't see him," she explains.

Not long before the latest version of The Legend of Zelda launched, Naomi found herself looking at a picture of a guardian robot – an eight-legged machine that can be either stationary or able to move about. In the game, these guardians can rotate their heads and attack you with a laser.

▶ Naomi spent hours painting the details to give the Guardian webcam an authentic Zelda feel





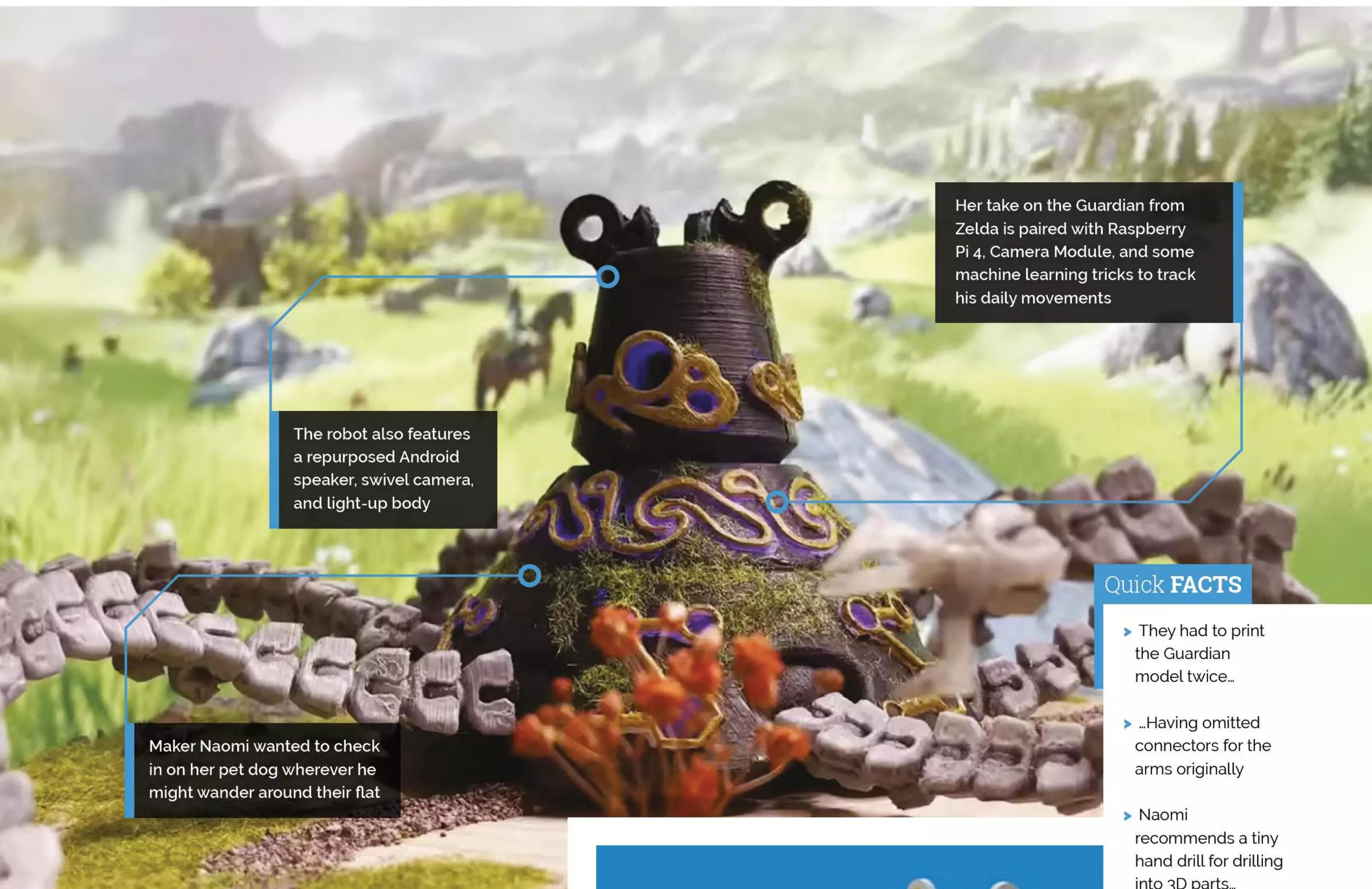

Her take on the Guardian from Zelda is paired with Raspberry Pi 4, Camera Module, and some machine learning tricks to track his daily movements

The robot also features a repurposed Android speaker, swivel camera, and light-up body

Maker Naomi wanted to check in on her pet dog wherever he might wander around their flat

#### Quick FACTS

- ▶ They had to print the Guardian model twice...
- ▶ ...Having omitted connectors for the arms originally
- ▶ Naomi recommends a tiny hand drill for drilling into 3D parts...
- ▶ ...Scavenging old gadgets for useful, quirky parts...
- ▶ ...And mixing your own craft paints for an authentic look

Obviously, it was only the former aspect that Naomi wanted to copy.

Naomi decided to 3D-print a Guardian model and place a camera where the laser is. She would mount the Guardian head on a servo, connect everything to Raspberry Pi, and create a functional Zelda Guardian to monitor her dog.

Naomi's first Raspberry Pi project, back in her student days, paired a Raspberry Pi with a camera to create a web-based security system, so she knew what to expect when planning this setup. Decorating the Zelda Guardian would be the real challenge and a great creative outlet. To add to the challenge, Naomi also decided to run Viam software on Raspberry Pi, and use a TensorFlow Lite machine learning model to detect her dog and program the Guardian to rotate the head to follow him around the room.

Raspberry Pi seemed a good choice since "it's powerful enough to run the machine learning model I needed, and it was easy to get a ribbon camera for it."

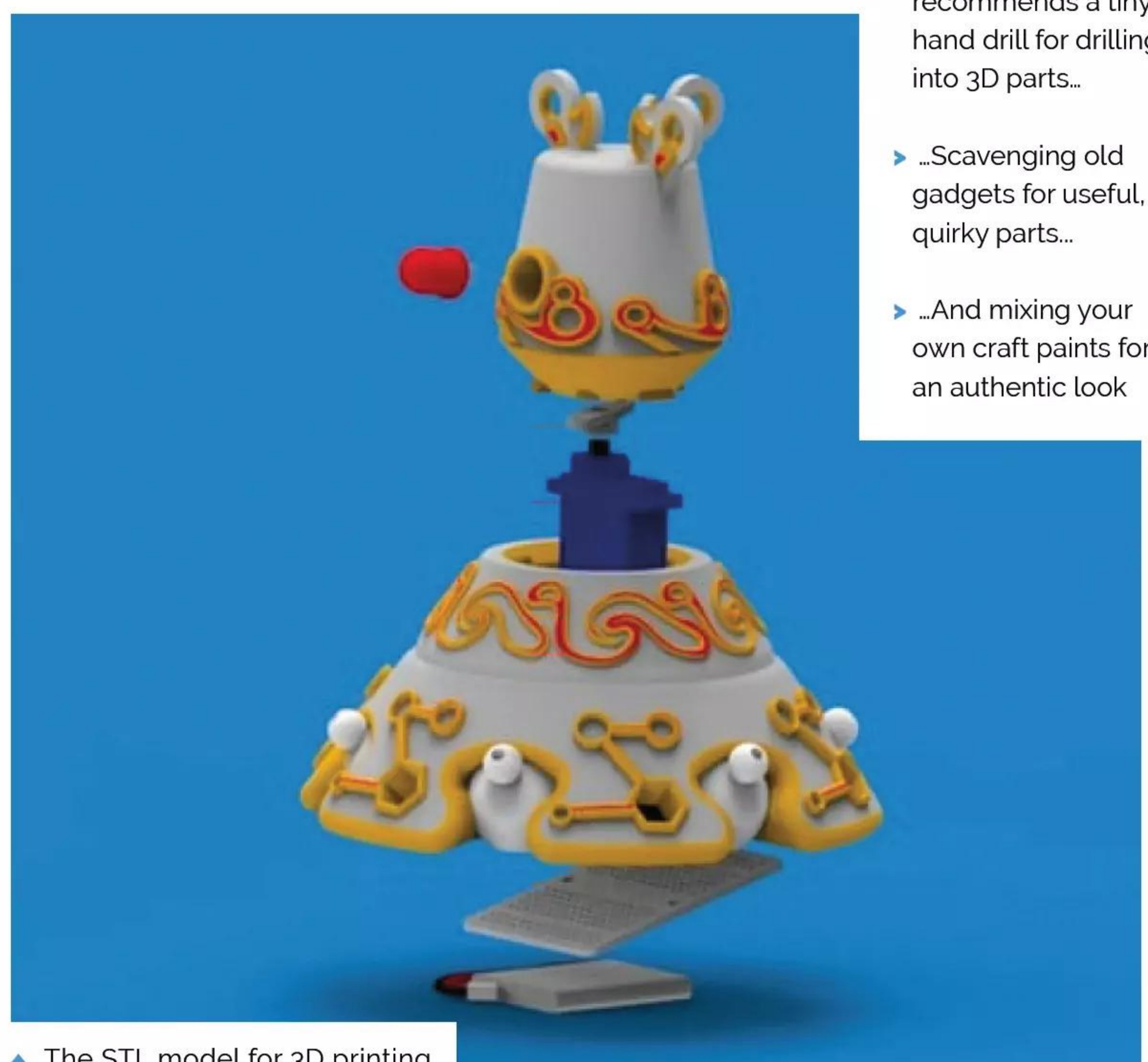

▲ The STL model for 3D printing

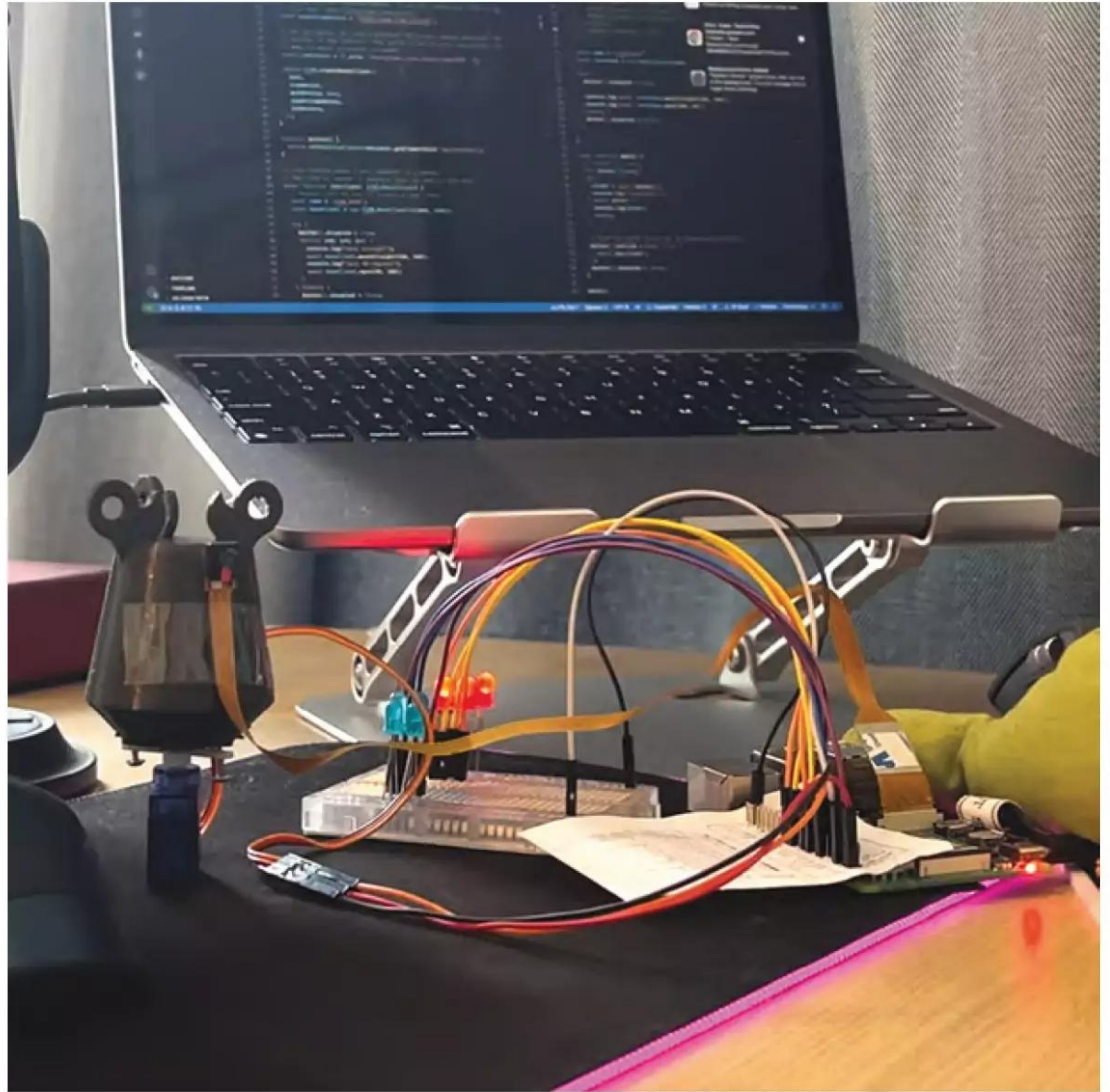

► The setup being prototyped on a desktop prior to the model being assembled



▲ TensorFlow detecting a human



### Team effort

“Luckily, I am not the first one to have the idea to build a Zelda Guardian and there was already a brilliant Guardian 3D model on Thingiverse ([magpi.cc/guardianstl](https://www.thingiverse.com/thing/348444)) with space for LEDs and a servo,” says Naomi. She chose a different Guardian head: [magpi.cc/guardian2stl](https://www.thingiverse.com/thing/348444).

Naomi asked her friend Hugh Rawlinson to help with the 3D printing using a filament that allows the light to shine through. Naomi then painted the parts that shouldn’t let any light through.

“Decorating the Zelda Guardian would be the real challenge and a great creative outlet”

Next, came the dual challenges of fitting components such as Raspberry Pi 4 and ensuring the camera stayed inside the head. Hugh helped her tweak the Guardian head’s design to include mount holes so she could attach a ribbon to a Raspberry Pi Camera Module v1.3. “Because they’d used the ribbon cable, the head couldn’t spin freely. However, for the space I wanted the Guardian for, 180 degrees of movement is enough, so I used a 180-degree servo,” explains Naomi.

Raspberry Pi itself needed some form of box to keep it upright inside the Guardian’s head. She hit on the idea of slotting it inside a tranche of tree trunk, and was able to recruit her partner to assist with the woodwork, cutting into the tree slice and giving the Guardian a beautiful base. Naomi then put it all together and painted it to look like the real thing. [M](#)

▲ The Zelda Guardian camera successfully recognises Ernie

## Get guarding



**01** Naomi sensibly used existing Thingiverse models and 3D-printed the versions she wanted, based on her vision.

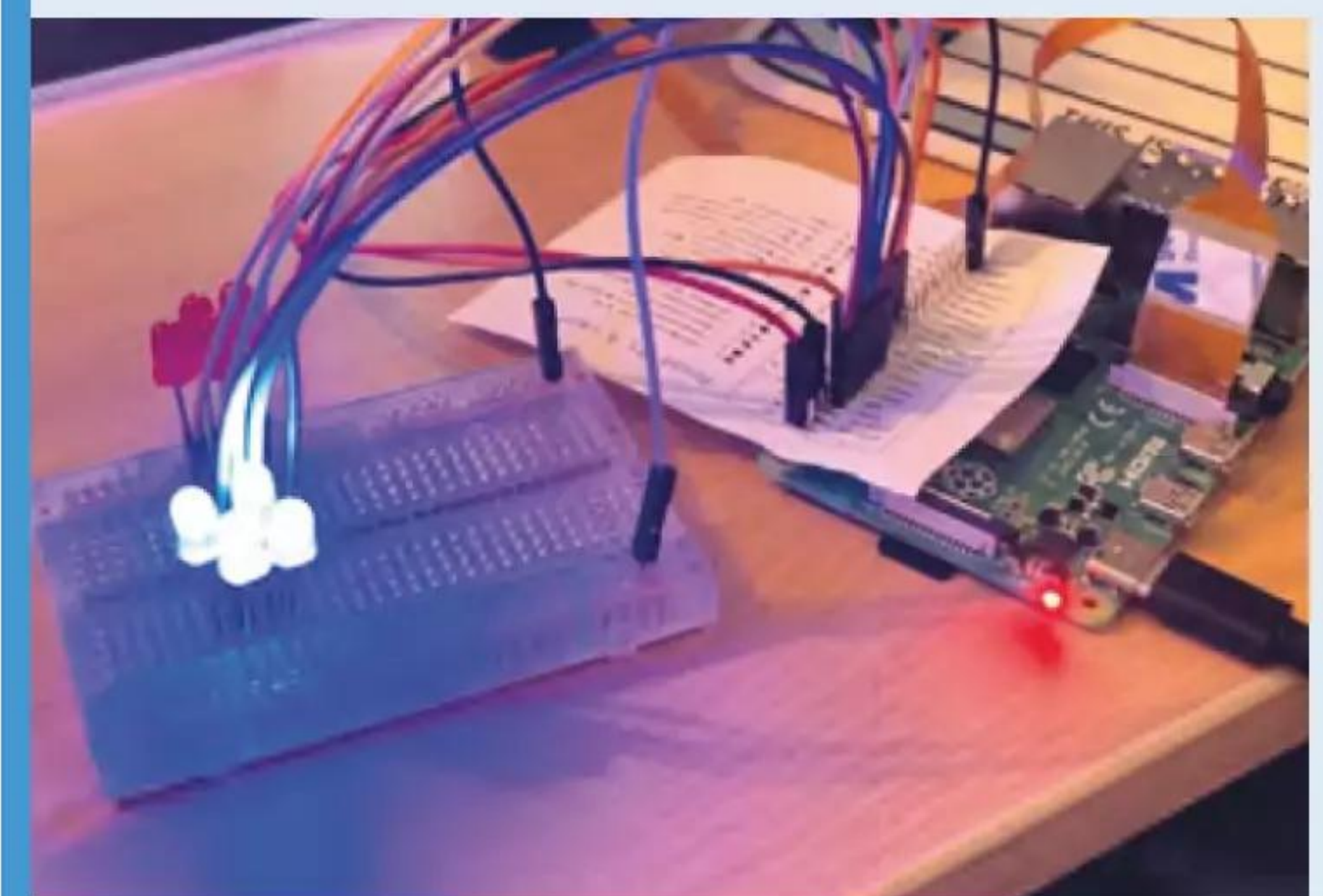

**02** An 8GB Raspberry Pi 4 with Raspberry Pi Camera Module v1.3 and a servo sit inside the head. Naomi’s code for the project is at [magpi.cc/guardianmainpy](https://www.magpi.cc/guardianmainpy).

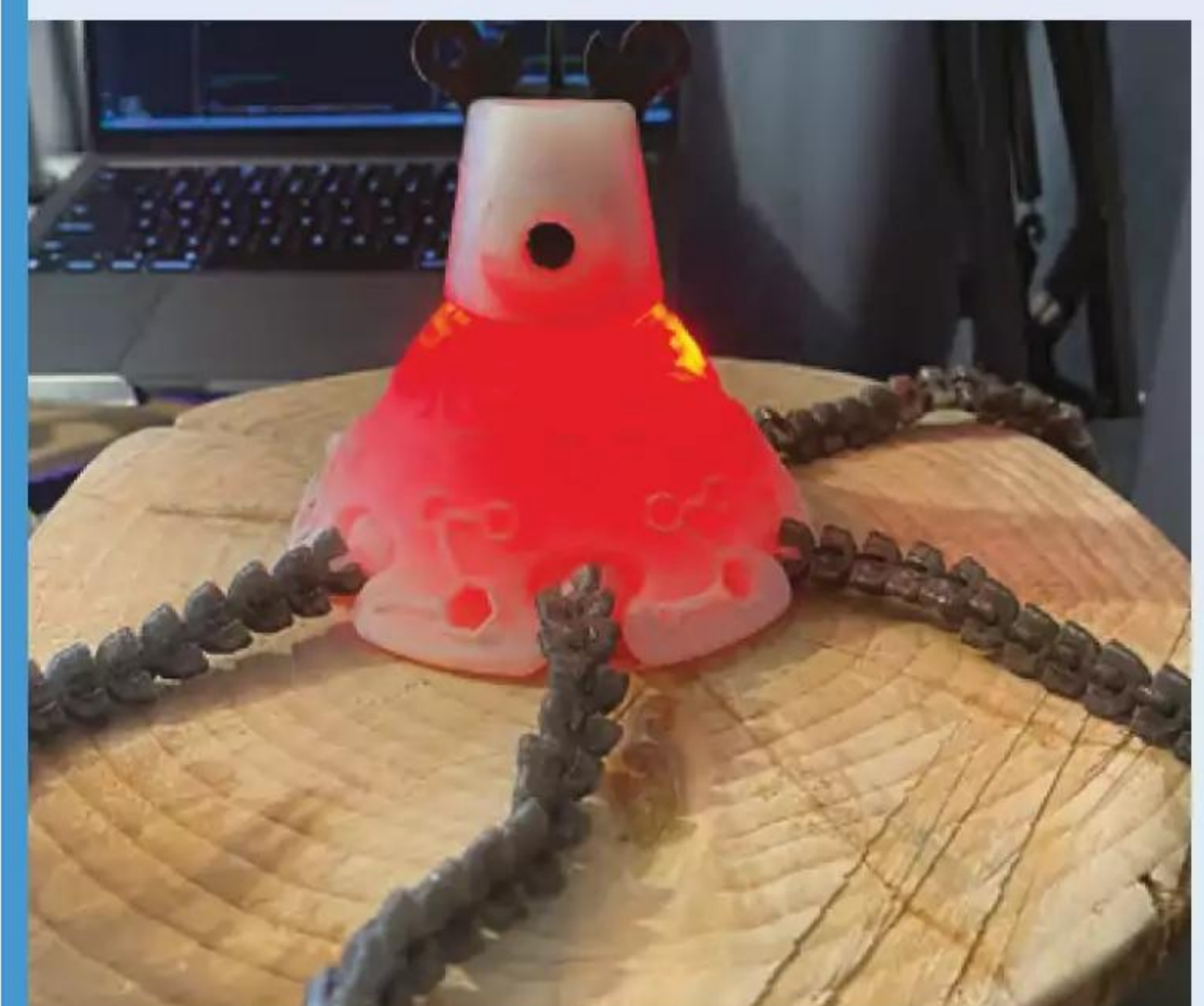

**03** An old Android speaker came in handy. Detailed build and decoration instructions, along with the Viam machine learning elements, are covered in Naomi’s Instructable: [magpi.cc/guardianguide](https://www.instructables.com/Zelda-Guardian-security-camera/).

# The Oracle

Has Evan Holbert created the future of fortune telling courtesy of a Game Boy, ChatGPT, and Raspberry Pi? **David Crookes** finds out



**MAKER** Evan Holbert

By day, Evan Holbert is a SCADA and automation engineer working in power systems. He's a maker and Game Boy modder in his free time.

[magpi.cc/theoracle](http://magpi.cc/theoracle)

**W**e often wish we could foresee the future – that way, we could get very excited learning about all of the many amazing Raspberry Pi goodies that are sure to await us over the next decade! At the very least, we'd be able to pre-empt the disappointment over our favourite sports team's defeats each weekend. If only there was a way...

Step forward Evan Holbert and his amazing (forward) looking project: The Oracle. It reminds us in some way of Zoltar from the classic Tom Hanks movie *Big*, since it allows you to insert a coin, enter your birthday, and read your fortune.

The difference is that this one doesn't have a scary face. Instead, it makes use of a stripped back Nintendo Game Boy hooked up to a Raspberry Pi Zero W computer.

## Oh wise one

The idea came when Evan, who enjoys modding Game Boys, wanted to create a show-stopping project for Open Sauce, a two-day maker event in San Francisco. "It started from a deep-seated infatuation with the type of esoteric, DIY weirdness you find in tourist traps, roadside attractions, and boardwalks," he says. "Coin-op stuff just fills a very specific niche in my soul."

To create the project, Evan looked to salvage parts that were knocking around his workshop. Since he wanted to present a booth at the show about modding, one of his decisions was to take a Game Boy and remove the case. "This was for aesthetic effect although the payoff wasn't quite what I envisioned," he explains. "I wanted more of a 'Neo plugged into the Matrix', cyberpunk sort of vibe."

Even so, it presented a great opportunity. The Game Boy screen could be used to display the Oracle's visage, Evan mused, while an LCD screen could display any information the user inputted. The handheld games console could then be controlled by relay modules that 'pressed' the buttons, to make it look as if the machine was bursting into life. "I wanted to make use of A, B, Up, Down, Left, Right, Start, and Select, although technically B and Left are not used for this application," he notes.

## Reading minds

The brains of the operation was always going to be Raspberry Pi, however. "It facilitates all the I/O necessary for interfacing the pinpad, coin mechanism, LCD, and relay modules," Evan continues. Raspberry Pi also connects to a

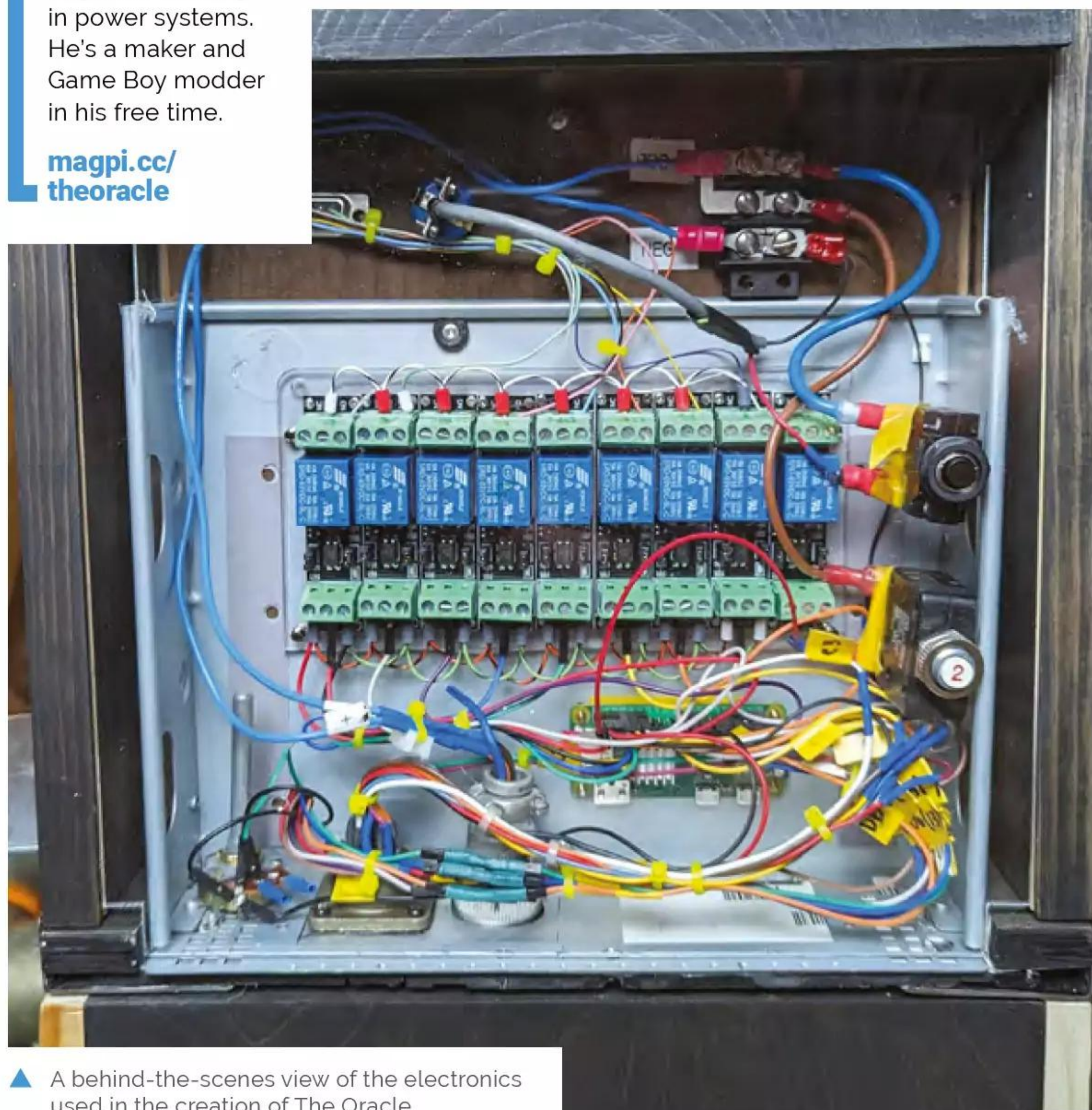

▲ A behind-the-scenes view of the electronics used in the creation of The Oracle

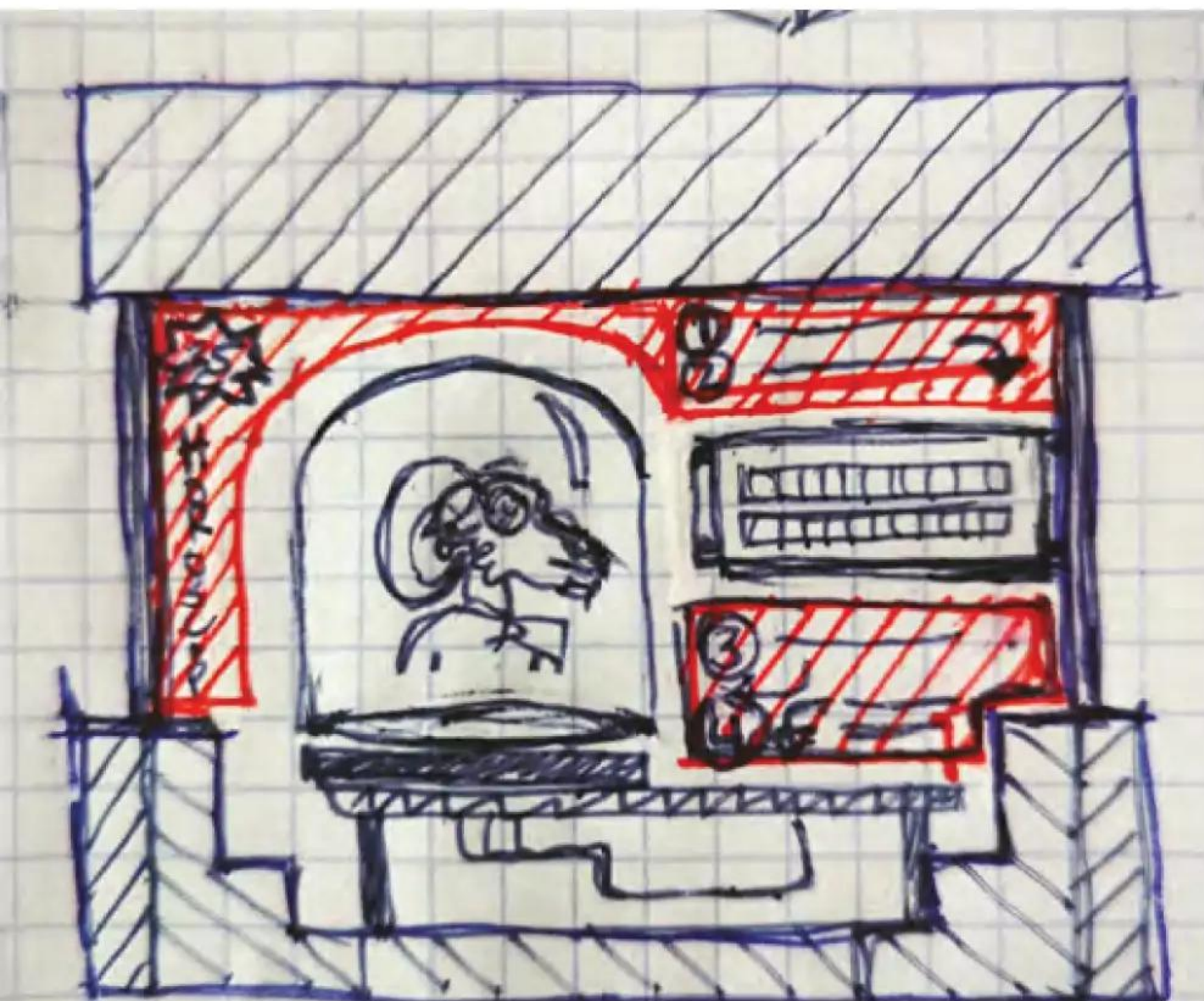

▲ Evan sketched out his project, as well as an image of the Oracle's visage for use on the Game Boy screen

Bluetooth Low Energy printer which allows the fortunes to be outputted on to paper.

But how are the fortunes told? Simple! When a birth date is inputted, the information is parsed to ChatGPT so that a horoscope can be generated in the style of American writer HP Lovecraft or children's author Dr Seuss.

"Raspberry Pi uses the ChatGPT API, turns the returned string into a bitmap, and appends

“ Coin-op stuff just fills a very specific niche in my soul ”

it to a static logo bitmap I created in [the open-source image editor GNU IMP],” Evan says. “I also used ChatGPT to help me create the Python code running on Raspberry Pi – I'd copy and paste errors back into ChatGPT, then rinse and repeat.”

Thankfully, it turned out largely as he had envisioned and it's got people raving. “My favourite reactions were those at Open Sauce – the ‘wows’ and the ones who questioned how I'd even come up with this,” he recalls. “But some people also noticed little details, such as the fact they were staring into a darkened Game Boy screen that says ‘Scrying’, which in itself is a form of scrying [divination involving gazing]. The online response has also been generally positive.” Just as The Oracle would have predicted, we'd guess. 

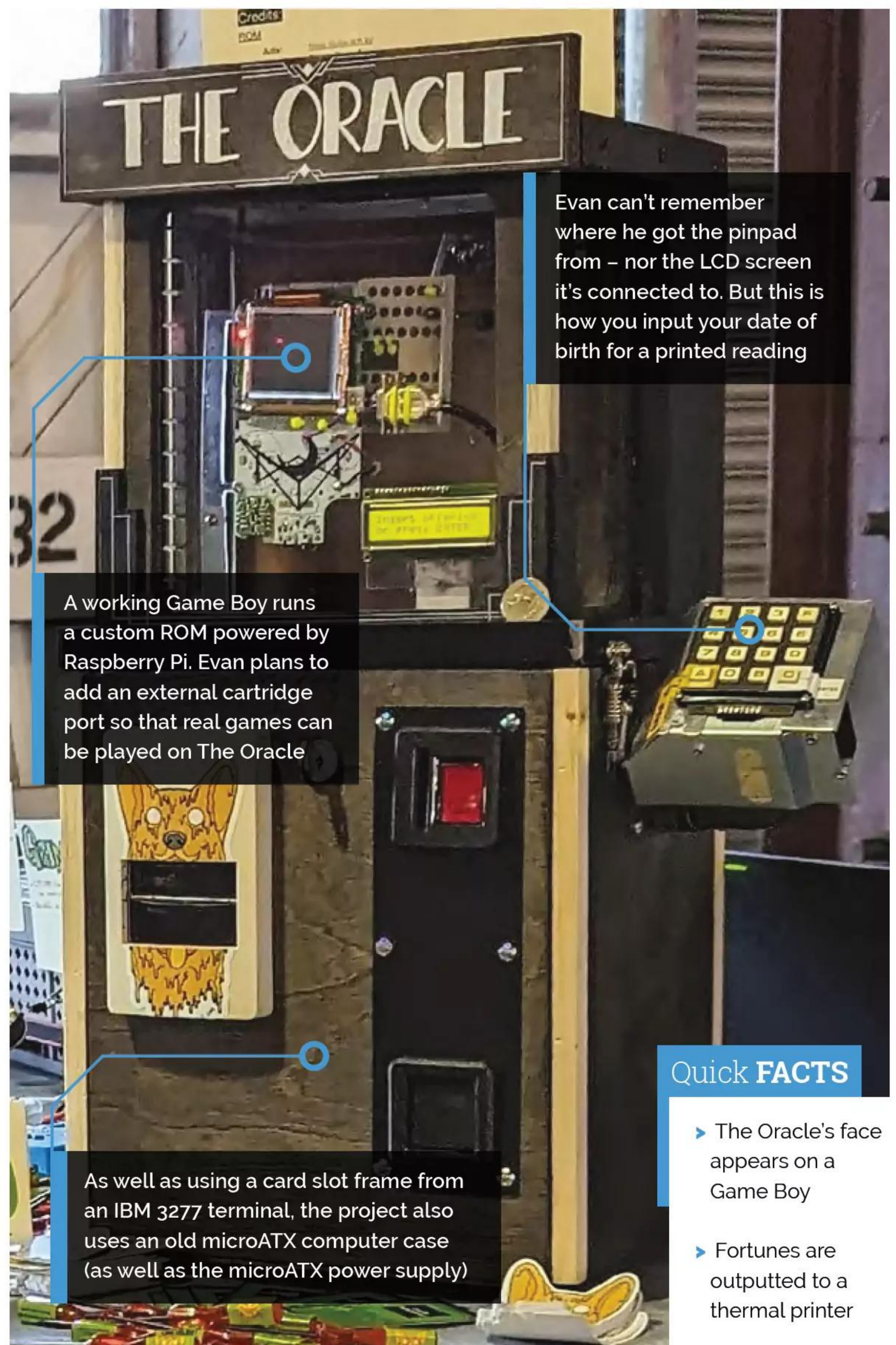

Evan can't remember where he got the pinpad from – nor the LCD screen it's connected to. But this is how you input your date of birth for a printed reading

A working Game Boy runs a custom ROM powered by Raspberry Pi. Evan plans to add an external cartridge port so that real games can be played on The Oracle

As well as using a card slot frame from an IBM 3277 terminal, the project also uses an old microATX computer case (as well as the microATX power supply)

#### Quick FACTS

- ▶ The Oracle's face appears on a Game Boy
- ▶ Fortunes are outputted to a thermal printer
- ▶ Evan aimed for a cyberpunk look
- ▶ The project took 300 hours to create
- ▶ It was 2% planning, 98% experimentation

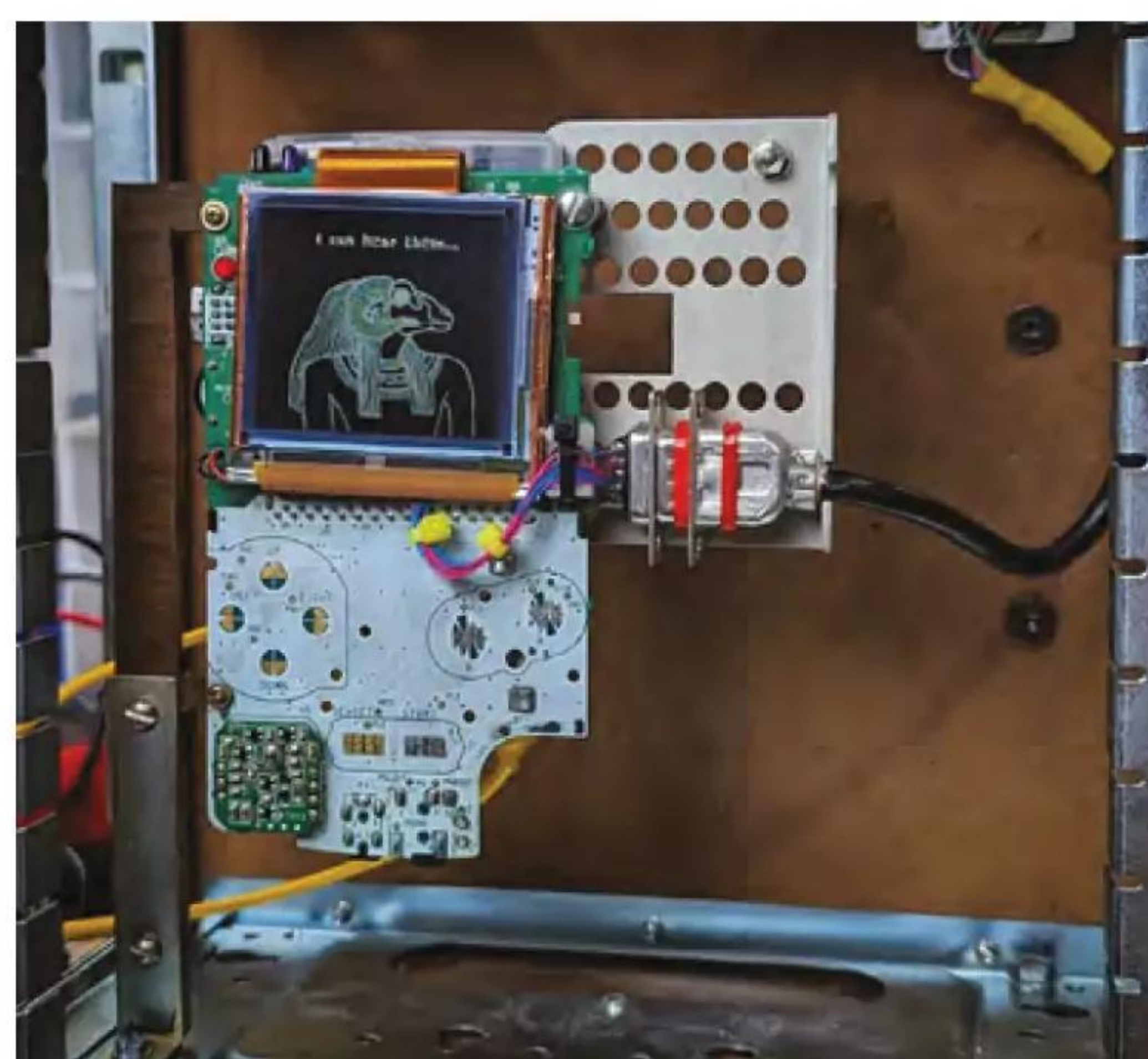

◀ The Oracle's visage was transferred to the ROM, developed for the Game Boy by Julss ([juls.itch.io](https://juls.itch.io)), a game designer Evan hired on Fiverr. She also created the Scrying animation

SUCCESS STORY [magpi.cc/success](https://magpi.cc/success)

# Sarawak, Malaysia primary schools

Raspberry Pi supports digital skills in every primary school in Malaysia's largest state. By **Rosie Hattersley**

**T**he Ministry of Education, Innovation and Talent Development ([meitd.sarawak.gov.my](https://meitd.sarawak.gov.my)) in Sarawak, the largest of Malaysia's 13 states, needed an effective and affordable solution to the lack of computer facilities in its primary schools. Local Raspberry Pi Approved Reseller Cytron ([my.cytron.io](https://my.cytron.io)) developed a Raspberry Pi 4 kit with a bespoke software setup to meet the needs of all 1265 schools.

Digital skills are a vital part of education from primary school onwards, but many schools in Sarawak lacked basic computer facilities to support the teaching and learning of these skills. The state's education ministry turned its attention to how it might ensure access to a consistently high

standard of facilities and teaching for children across the region, including in rural areas where the availability of internet infrastructure can't be assumed.

## THE CHALLENGE

In 2021, the Ministry of Education, Innovation and Talent Development in Sarawak set an ambitious goal for supporting the innovation and digital skills of primary school-aged children. They wanted to give students at every school access to computing hardware and software that would help them not only to acquire the ICT skills they will need for work and everyday life, but also to gain experience in coding and physical computing – building electronics projects by connecting components.

With over 1200 schools to equip, the solution would need to be affordable. A further consideration was that schools in some rural areas of Sarawak do not have reliable internet access. Like their peers in other regions, students in these areas need to become familiar with using the internet to access information, but lack of infrastructure poses a problem.

## THE SOLUTION

Raspberry Pi 4 was chosen for the project, and Cytron, a local Raspberry Pi Approved Reseller, supplied over 9400 computer kits for all 1265 schools across the state, with every school receiving several units. As well as a Raspberry Pi 4, each one included a case, monitor, keyboard, mouse, SD card, power supply, and HDMI cable.



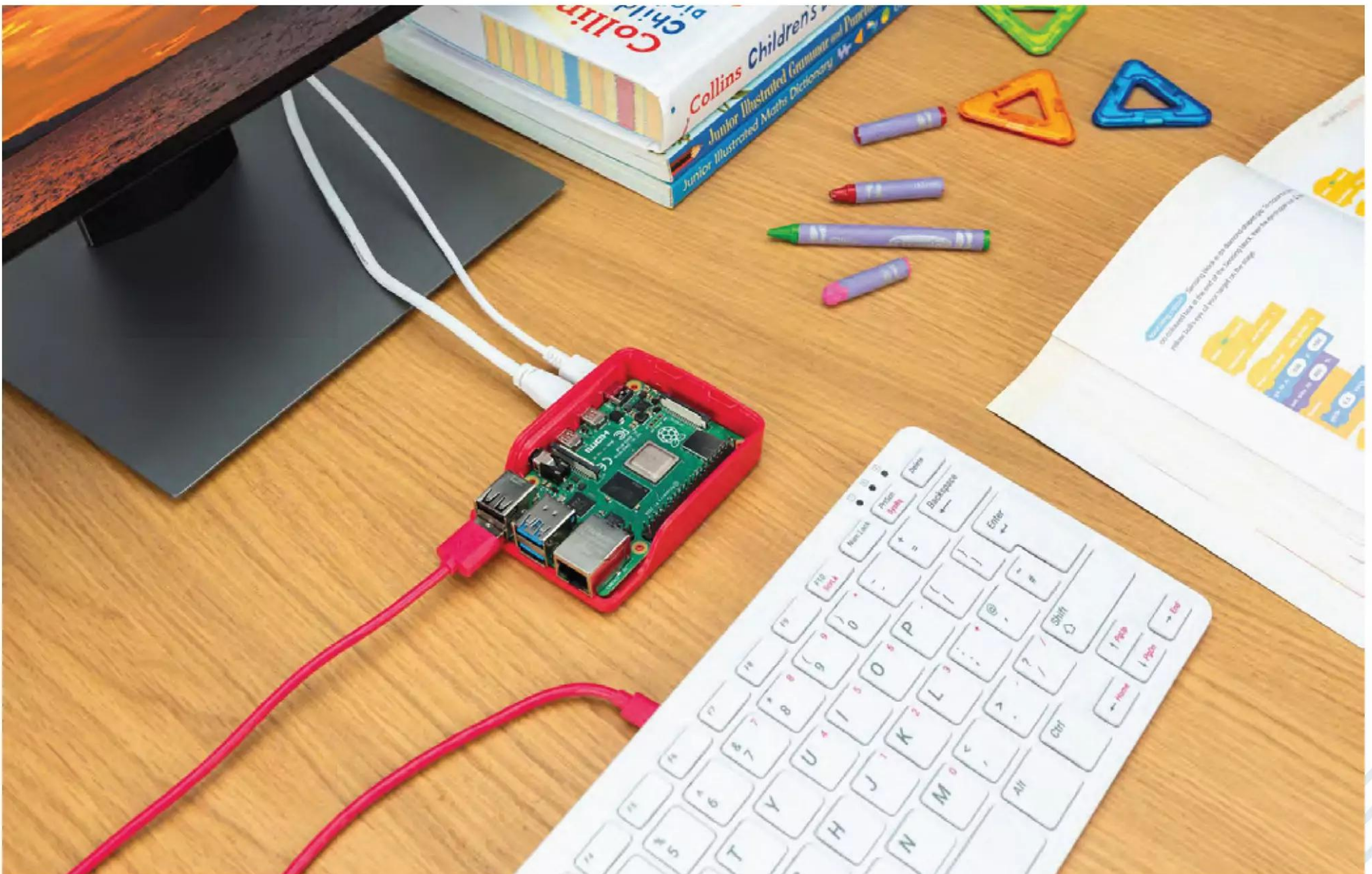

Working closely with Sarawak’s Ministry of Education, Cytron also produced a bespoke version of Raspberry Pi’s free operating system, Raspberry Pi OS, that is tailored for local primary schools. Cytron preloaded this custom OS onto the SD cards supplied with the kits.

To make sure that every kit would work right out of the box, Cytron assembled and tested each one before packing it. And in order to address internet infrastructure problems, some of the Raspberry Pi computers supplied were set up to function as internet-in-a-box offline servers that would allow educational content to be preloaded and accessed by rural schools that don’t have reliable access to the internet.

The Ministry of Education planned a Raspberry Pi training programme to make sure primary schools were able to get the most out of their new equipment. Delivered by higher education partners, the programme would provide training for at least one teacher in every primary school throughout Sarawak.

### WHY RASPBERRY PI?

With fast processing power and networking, USB 3.0, dual-display support, and a choice of RAM options for a range of different tasks, as well as a set of 40 accessible GPIO pins for quickly

and easily connecting electronic components, Raspberry Pi 4 is Raspberry Pi’s most popular and most adaptable computer. It is the ideal choice for teaching and learning a wide range of computing subjects, from physical computing and robotics to programming. Importantly, it’s just as well suited for use as a desktop computer, so students can develop a range of essential ICT skills.

“ The local Raspberry Pi Approved Reseller assembled and tested every single unit ”

Raspberry Pi’s recommended – and free – operating system, Raspberry Pi OS, offers a familiar desktop environment for learning computer science and doing day-to-day classwork. It provided an excellent basis for the customised learning environment that Cytron devised for Sarawak’s primary schools.

“The Raspberry Pi computer is a good learning and teaching tool, especially for children at primary school or secondary school level,” says Dr

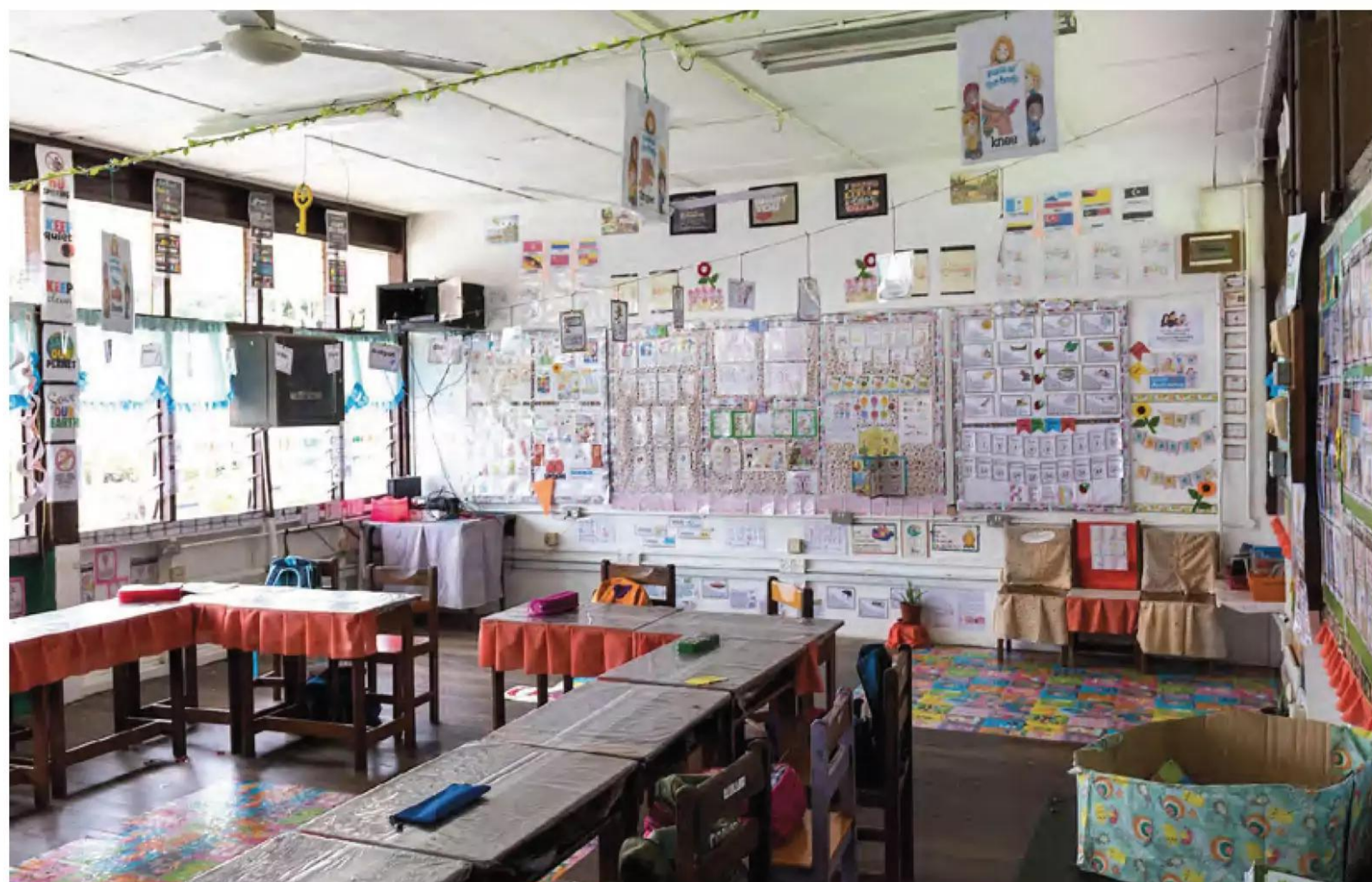

Hudyjaya Siswoyo Jo, master trainer in Sarawak’s Raspberry Pi training programme for primary school teachers. “Not only is it able to serve as a normal computer, Raspberry Pi can also be used to teach concepts such as physical computing. And the tools included inside the Raspberry Pi operating system allow students and teachers to collaborate.”

Meanwhile, the ability to set up some of the computers as offline servers was invaluable. “Raspberry Pi and its internet-in-a-box function is a very powerful tool to improve the teaching and learning in schools, as it can bring knowledge and learning content to pupils who are offline or without internet access: for example, anybody nearby with an old smartphone, tablet or computer,” says Education, Science and Technological Research Minister, Datuk Amar Michael Manyin Jawong.

### THE RESULTS

With Raspberry Pi kits in every Sarawak primary school by the end of 2021, the Ministry of Education was ready to embark on its teacher training programme. By the end of 2022, at least one teacher in every school had received two levels of basic training, with plans in place for further

training over the following two years. The aim of the programme is to equip teachers to teach computing skills to students so they can develop apps and games and solve real-world problems.

Both ministry officials and teachers are delighted with the initiative so far. Datuk Roland

“ Raspberry Pi helps empower pupils to learn computing and become more creative in problem-solving ”

Sagah, Sarawak’s Education, Innovation and Talent Development Minister, commented that it supports the ministry’s objective of promoting STEM and ICT education to students in the state. And school staff who participated in the training programme praised the educational value of the new platform, as well as how simple and easy it is to use. “Raspberry Pi helps empower pupils to learn computing and become confident and more creative in problem-solving,” enthused one teacher. 



TCP Offload Ethernet for Edge devices

# TOE<sub>4</sub> Edge



**Fast**



**Stable**



\$1.89/unit, 10K pcs

## CoreMark Score



Tested on a Cortex M0+ by continuously sending and receiving TCP data from an echo server

## Iperf performance (Mbps)



Tested by Iperf at SPI 60Mhz

## TOE Chip Applications

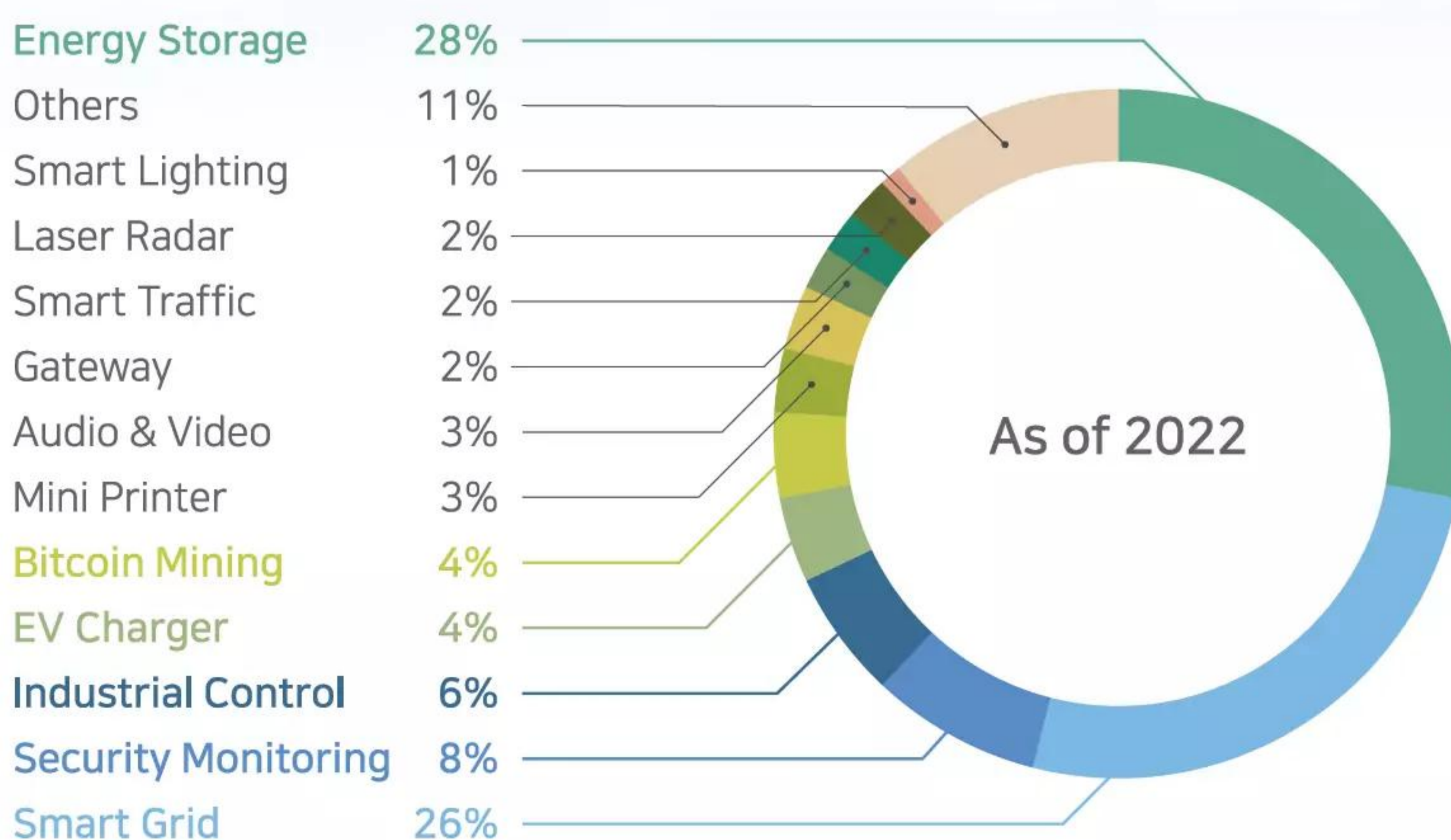

## W6100-EVB-Pico

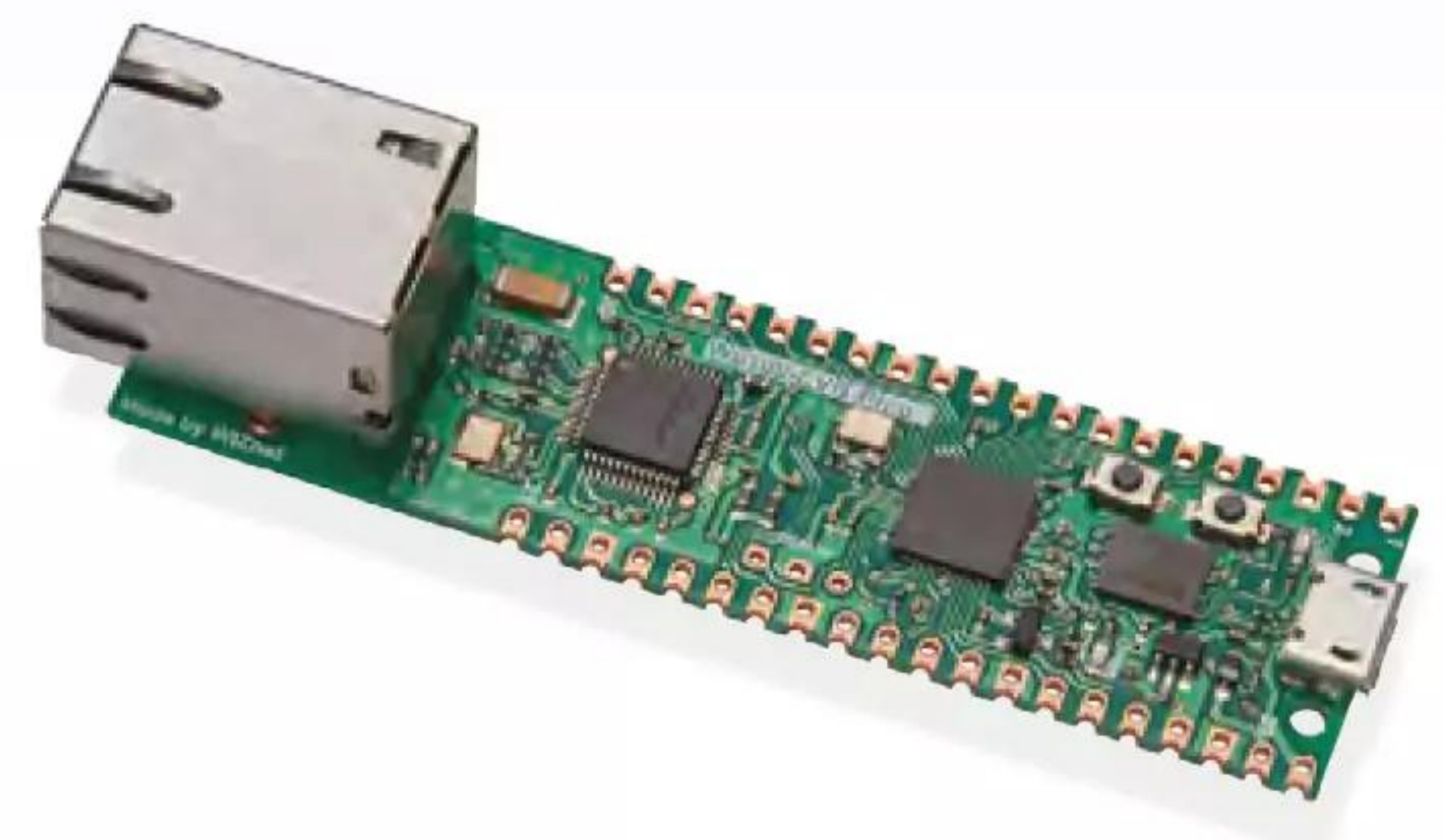

Powered by Raspberry Pi

\$9.95

# Make a low-cost oscilloscope with Scopy

With Raspberry Pi Pico and the Scopy app, you can test circuits and more



**Phil King**

A long-time contributor to *The MagPi*, Phil is a freelance writer and editor with a focus on technology.

@philkingeditor

**W**hile a multimeter is useful for measuring aspects of electronic circuits, an oscilloscope works at a higher frequency and so can show the voltage waveforms in real-time. That's why it's such a handy tool for testing and debugging circuit designs, among many other uses over a wide range of fields.

For the electronics hobbyist, commercial oscilloscopes can seem pretty pricey, so the option to make your own using just a Raspberry Pi Pico and the free Scopy Android app is very appealing. We'll cover how to set it up and use it in a circuit experiment to measure the time for a capacitor to charge.

## 01 Install Scopy app

First, you need an Android phone or tablet that works with USB OTG (most modern devices will) – or you can connect via Wi-Fi if using a Pico W. The Scopy Android app can be found in the Google Play Store: [magpi.cc/scopyapp](https://magpi.cc/scopyapp). It's free to download and use, with an optional in-app purchase (£1.99) to remove the ad banner and enable the second analogue channel.

## 02 Flash Scopy firmware

For Pico to communicate with the Android app, you'll need to install the special Scopy firmware. There are two versions available from the Scopy 'Getting Started' wiki page ([magpi.cc/scopygs](https://magpi.cc/scopygs)), for standard Pico and Pico W. Make sure you download the correct version for your board.

It's a UF2 file that you can flash to Pico in the normal way: connect Pico via USB to a computer while holding its BOOTSEL button, then drag and drop the Scopy firmware file to the mounted drive (usually called 'RPI-RP2').

## 03 Connect Pico to app

For a standard Pico board, you'll need to connect it to your Android device via a USB OTG adapter/cable. Plug it in and you should see Pico's status LED flashing. You'll be prompted in the Scopy app to allow connection to Pico – press 'OK' and the bottom-left connection indicator should then change to 'USB OK'.

If using Pico W, you can connect it to the app via Wi-Fi. There are two setup methods for this (see the wiki page: [magpi.cc/scopywifi](https://magpi.cc/scopywifi)). The

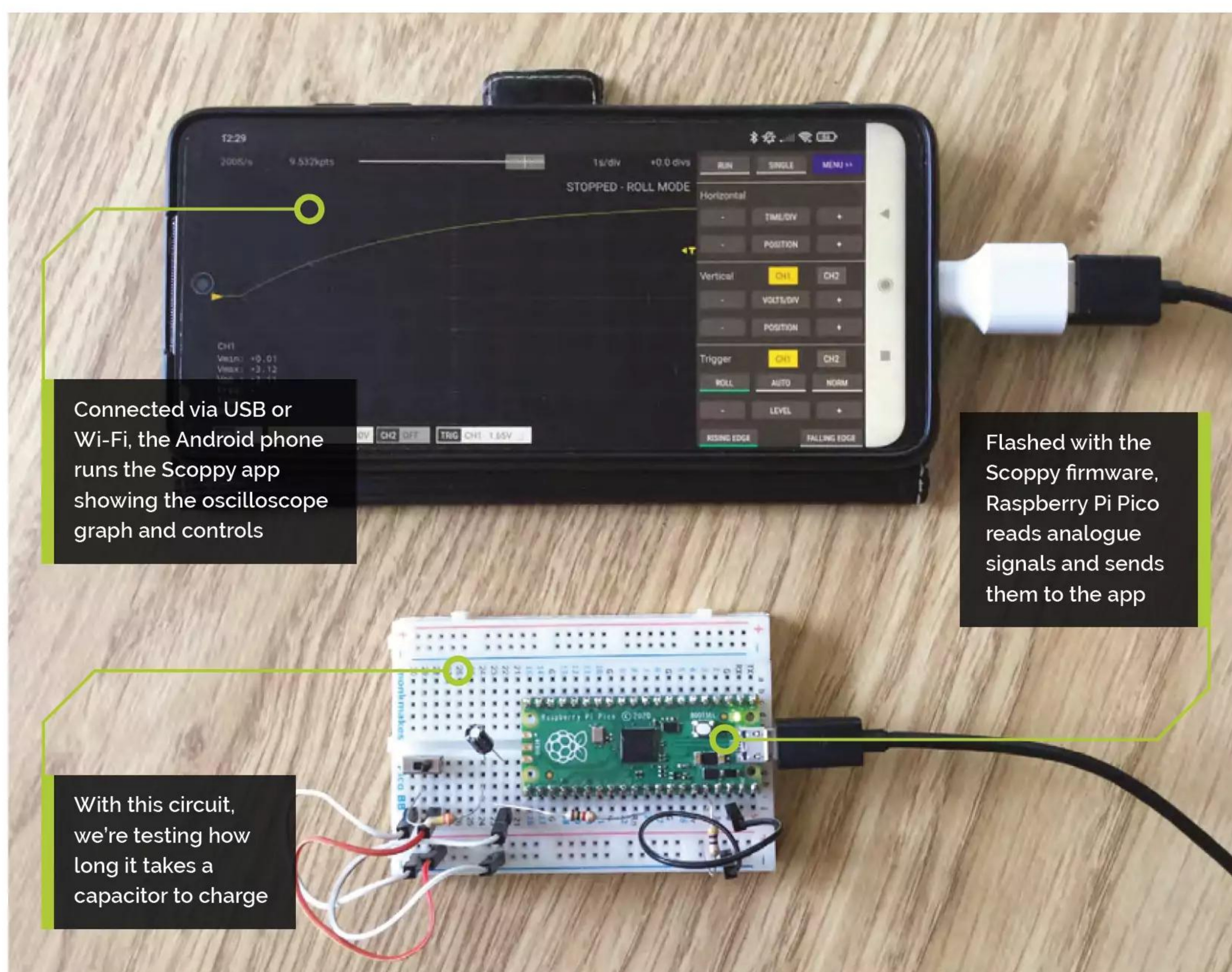

### You'll Need

- ▶ Raspberry Pi Pico or Pico W
- ▶ Scopy firmware [magpi.cc/scopy](https://magpi.cc/scopy)
- ▶ Android device
- ▶ USB OTG adapter (Pico only)

### Top Tip

#### Scopy discussions

If you want to troubleshoot an issue, the Scopy discussions board ([magpi.cc/scopydiscuss](https://magpi.cc/scopydiscuss)) may help you to find a solution.

easiest is to connect the Android device via USB OTG first, as for Pico, then press 'USB OK' and select Connected Device > Firmware Settings. Select your Wi-Fi Country, then change the Wi-Fi Mode to 'Station/Client' and enter your router's SSID name and password. Tap OK to connect Pico W to Wi-Fi. Disconnect it from USB, then tap 'USB OK' and select Change Connection Type > Wi-Fi. With Pico W powered up, it should quickly connect.

## 04 Read a test signal

The Pico firmware can generate a test signal from the GPIO22 pin. By connecting this to GPIO26 (ADC0, the default pin for analogue CH1), you can read the signal in the app – press the Run button and you should see the default test signal of a square wave. If it looks too compressed on the graph, try increasing the Time/Div setting by pressing '+' in the controls – or pinch and spread your fingers on the graph. You can also adjust the vertical Volts/Div and position. In addition, the frequency of the signal can be altered by selecting the Signal Generator option in the app's menu.

Note: If you are connecting a signal from another source, make sure it's within the range of

0 to 3.3V, otherwise you may well damage Pico. See Step 11 for more details.

## 05 Sine wave

In the Signal Generator menu option, the test signal can be switched to a 'Sine (PWM)' output where the duty cycle changes according to the sine function. If the GPIO 22 and GPIO 26 pins are connected with a jumper wire, the app graph will show a square wave with variable frequency. You can convert it into an approximation of a sine wave by connecting the pins with a high-value resistor (e.g. 330 kΩ) instead. This

▶ The Android app showing the square wave test signal from GPIO 22 on a YT graph

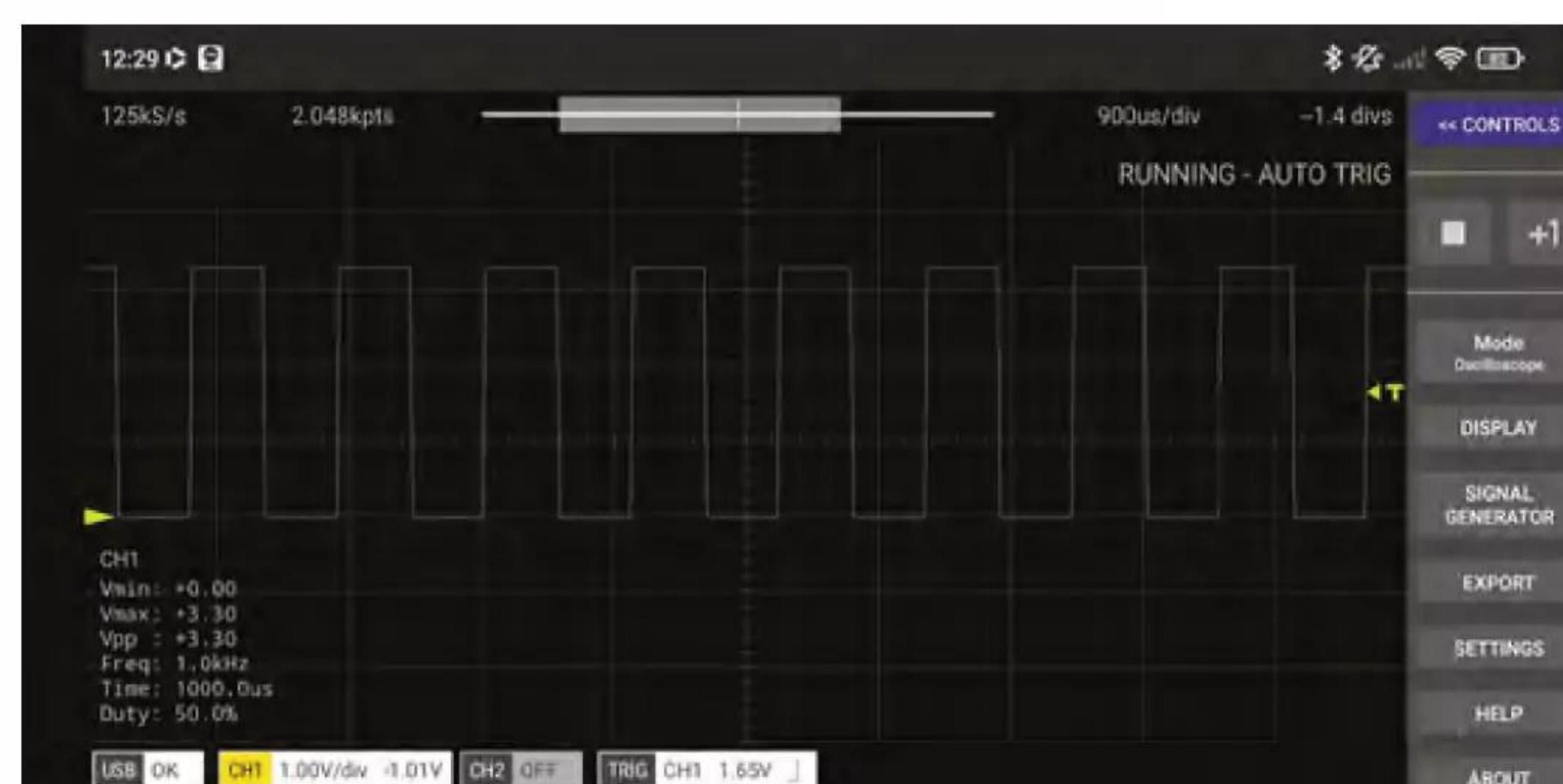

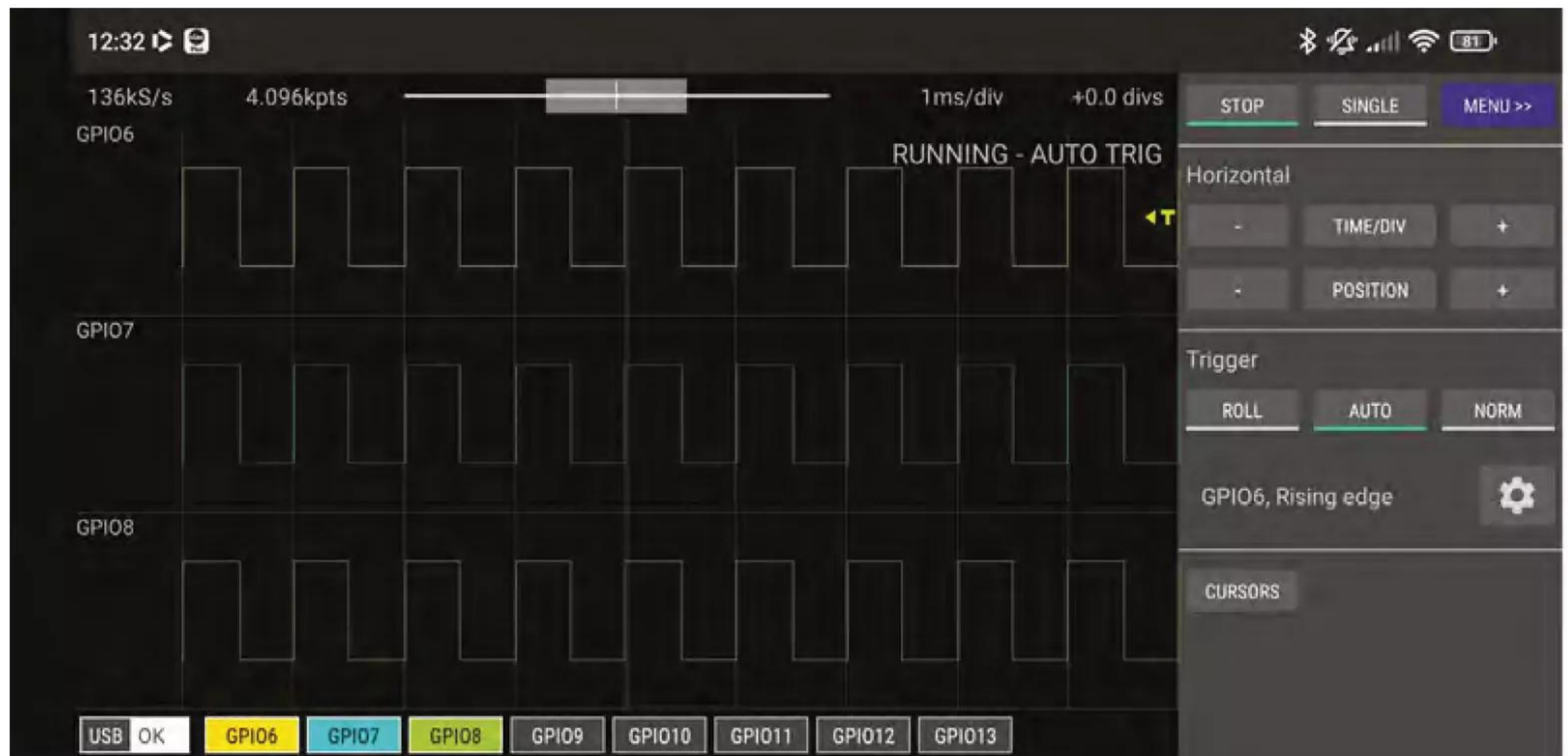

▶ The app includes a logic analyser mode so you can monitor signals on up to eight GPIO pins

“ Now you have a working oscilloscope, you can use it to measure values from connected circuits or other sources ”

works pretty well, although you could always construct a proper low-pass filter using a resistor and capacitor.

## 06 App display

By selecting Display in the app’s menu, you can alter how the reading is shown. The default is in the YT graph, but you can switch this to an FFT (Fast Fourier Transform) which breaks

▼ **Figure 1:** The wiring diagram for our capacitor charging circuit to measure the RC time constant

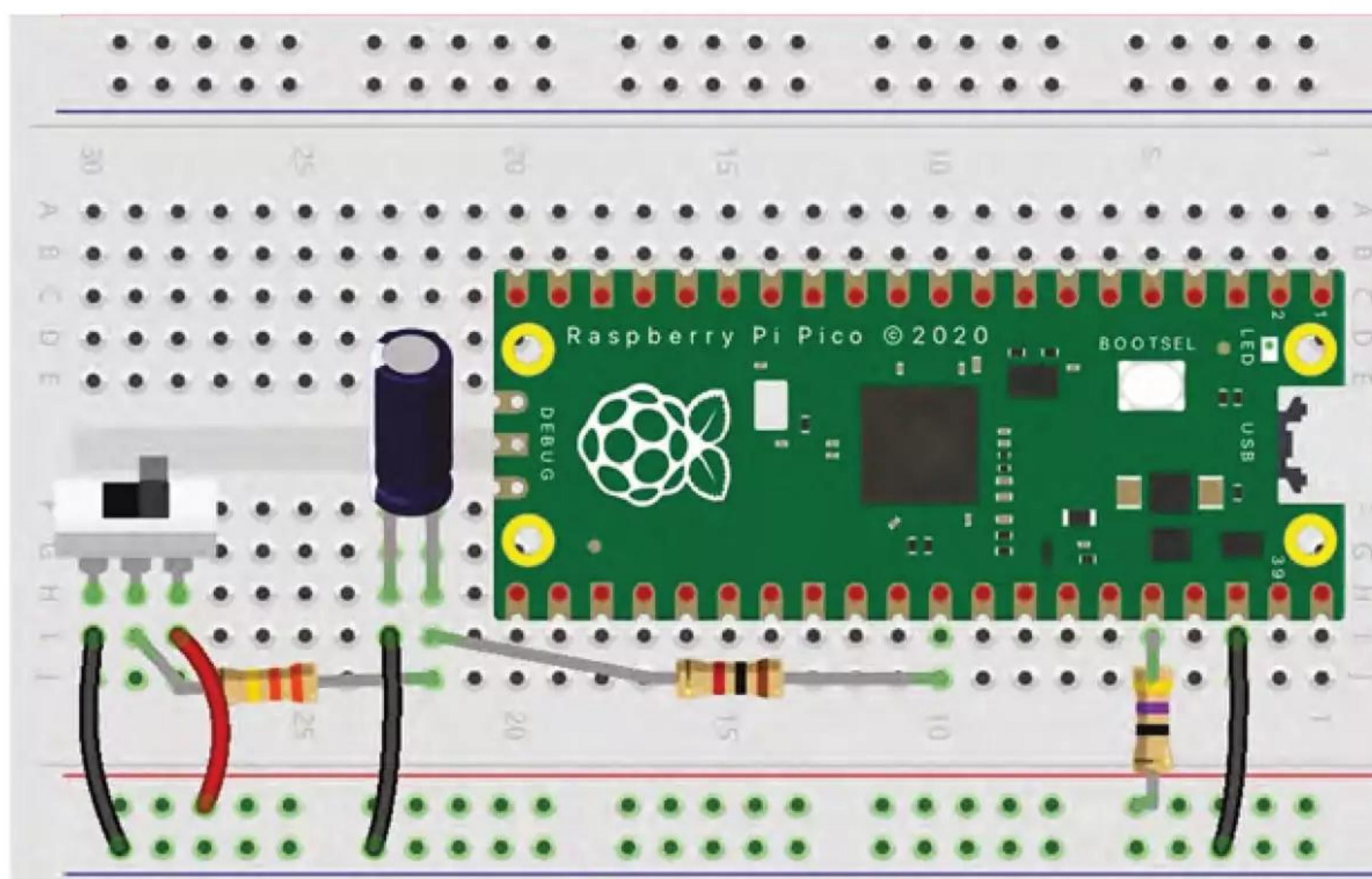

down any detected signal into a combination of sine waves of varying amplitudes and frequencies. You can select different ‘window’ function types: Hann, Hamming, Blackman, or Rectangle. The FFT graph can also be shown alongside the YT one.

For the other Display options, you’ll need a second signal on CH2 (GPIO28 / ADC1 by default). The XY view plots a channel on each axis, useful for examining phase differences. It can also be viewed alongside the YT graph.

## 07 Logic analyser

Scopy also features a logic analyser mode for viewing the digital signals on GPIO pins – useful for debugging circuits and programs. In the app menu, press the Mode button to switch from Oscilloscope to Logic Analyzer. The eight default GPIO pins covered are GPIO6, 7, 8, 9, 10, 11, 12, and 13. The starting (i.e. lowest) GPIO and range can be altered in the Firmware Settings. Each GPIO can be switched on or off at the bottom of the graph. By connecting a source (e.g. the test signal) to the pin, you’ll see it appear on the graph.

## 08 Time constant experiment

Shifting back into oscilloscope mode, let’s set up a simple circuit to measure its RC time constant, which is equal to the amount of time it takes a capacitor to charge to 63.2% ( $1 - e^{-1}$ ).

Wire up the circuit on a breadboard, as shown in **Figure 1**, but hold off connecting the 1kΩ resistor between the capacitor and GPIO26 until

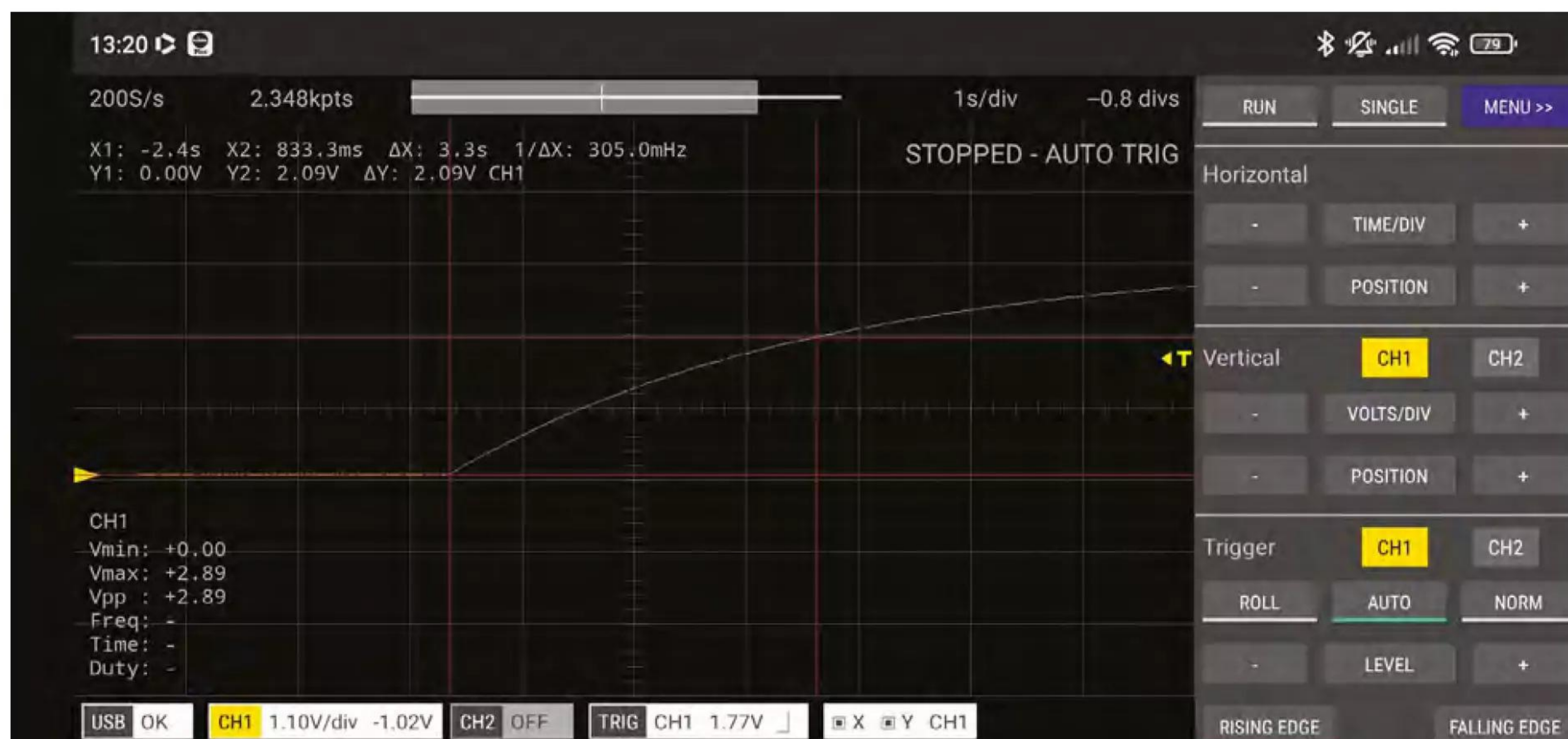

you've turned on Pico, as it's best not to send any current to an ADC while Pico is off. The  $10\mu\text{F}$  capacitor's positive leg is also connected via a high-value resistor (we chose  $330\text{k}\Omega$ ) to the output of a slide switch. The latter should be set to off for now. We're supplying power from the  $3.3\text{V}$  pin via a  $47\Omega$  resistor to prevent the possibility of a short in case of incorrect wiring.

## 09 Charge capacitor

With the circuit wired up (apart from the  $1\text{k}\Omega$  resistor to GPIO26), connect Pico to the Android app. Then connect that resistor.

In the app, set the Trigger to Roll – this mode will start displaying results immediately, in real-time, rather than waiting for a waveform to complete. Set the Time/Div level to  $1\text{s/div}$ , then hit the Run button to start measuring.

Now set the slider switch to the on position and you should see the voltage level rise gradually in a curve on the graph as the capacitor is charging up. When it gets close to the maximum  $3.3\text{V}$ , press Stop.

## 10 Measure time constant

You can now measure the time it took the capacitor to charge to 63.2%, which is approximately  $2.09\text{V}$ . Scroll to the bottom of the Controls panel and press Cursors. Two vertical

and two horizontal red lines should appear on the graph. Drag the bottom horizontal line to the  $0\text{V}$  level and the other to  $2.09\text{V}$  (zoom in if you need to). Then drag the left vertical line to where the curve starts rising from  $0\text{V}$  and the other to where the top vertical line intersects the curve at  $2.09\text{V}$ .

The time difference ( $\Delta X$ ) shown in the figures at the top left should be  $3.3\text{s}$  in the case of our  $330\text{k}\Omega$  resistor. This equates to the RC time constant, which also equals the product of the resistor and capacitor ratings in ohms and farads:  $R \times C = (330 \times 10^3) \times (10 \times 10^{-6}) = 3.3$ . If you change the  $330\text{k}\Omega$  resistor to a  $100\text{k}\Omega$  one, the result should be 1 second. You can also measure the time it takes the capacitor to discharge from  $2.09\text{V}$  to  $0\text{V}$ , which should be the same.

## 11 Taking it further

Now you have a working oscilloscope, you can use it to measure values from connected circuits or other sources. As mentioned, the bare Pico setup can only be used to measure a voltage range of  $0\text{V}$  to  $3.3\text{V}$ . To measure different voltage ranges, you can add an analogue front-end (essentially a fancy voltage divider). The Scopy wiki page ([magpi.cc/scopyfrontend](http://magpi.cc/scopyfrontend)) explains how this works and includes some designs. Alternatively, you can buy a ready-made FSCOPE-500K PCB – the schematic and PCB design are available on OSHWLab ([magpi.cc/fscopepcb](http://magpi.cc/fscopepcb)). 

▲ Positioning the red cursor lines to measure the time it takes the capacitor to charge to 63.2% ( $2.09\text{V}$ )

## Top Tip

### Firmware settings

In the Firmware Settings menu, you can alter aspects such as Wi-Fi connection details (Pico W), logic analyser GPIO pins, and voltage range and Vref pins for the ADC channels. See [magpi.cc/firmware](http://magpi.cc/firmware).

# Control a model railway

Get on the right track by controlling a model railway using a Raspberry Pi with motors and an H-bridge



**Stewart Watkiss**

MAKER

Also known as Penguin Tutor. Maker and YouTuber that loves all things Raspberry Pi and Pico. Author of Learn Electronics with Raspberry Pi.

[penguintutor.com](http://penguintutor.com)

[twitter.com/stewartwatkiss](https://twitter.com/stewartwatkiss)

## You'll Need

- L298N [magpi.cc/l298n](http://magpi.cc/l298n)
- Train set or 12V DC motor [magpi.cc/piborgmotor](http://magpi.cc/piborgmotor)
- 12V power supply [magpi.cc/12v2a](http://magpi.cc/12v2a)
- Jack to screw terminal [magpi.cc/fdcpa](http://magpi.cc/fdcpa)

**D**C motors are an important part of many electronic projects. This tutorial explains how they are used in a model railway with H-bridge drivers and pulse-width modulation (PWM). This will then help you understand how to use motors in other projects as well. The example uses the L298N H-bridge driver which is commonly available on a small printed circuit board (PCB). You'll also learn how you can create a web-based interface so that you can control the railway via a web page using a laptop or mobile phone.

## 01 Model railways

Analogue model railways have a DC motor inside the locomotive to convert electrical power into movement. The locomotive picks up the electricity from the rails through its metal wheels. The direction of the train is based on the polarity of the power to the tracks and the speed is determined by the voltage of the electricity.

To control the train using a Raspberry Pi, a motor driver is required. This normally uses an H-bridge integrated circuit, which allows the polarity to be set to the desired direction. Whilst a Raspberry Pi GPIO provides a digital (on or off) output, by using PWM the output can be switched on and off very quickly to simulate a varying voltage.

## 02 How DC motors work

DC motors create movement using an electromagnetic field. A simplified model of a DC motor is shown in **Figure 1**. When a current flows

through the windings, an electromagnetic field is created. The field interacts with the fixed magnets on the outside, opposite poles attracting and like poles repelling. This causes the spindle to rotate part-way around. The wires are connected to the internal windings through brushes and a rotating commutator. As the motor rotates, the commutator moves around, switching the polarity for the wirings; this reverses the polarity of the magnetic field and moves the spindle further around.

▼ **Figure 1:** A model showing the internal wiring for a DC motor. Brushes are often used to connect the wires to the rotating motor

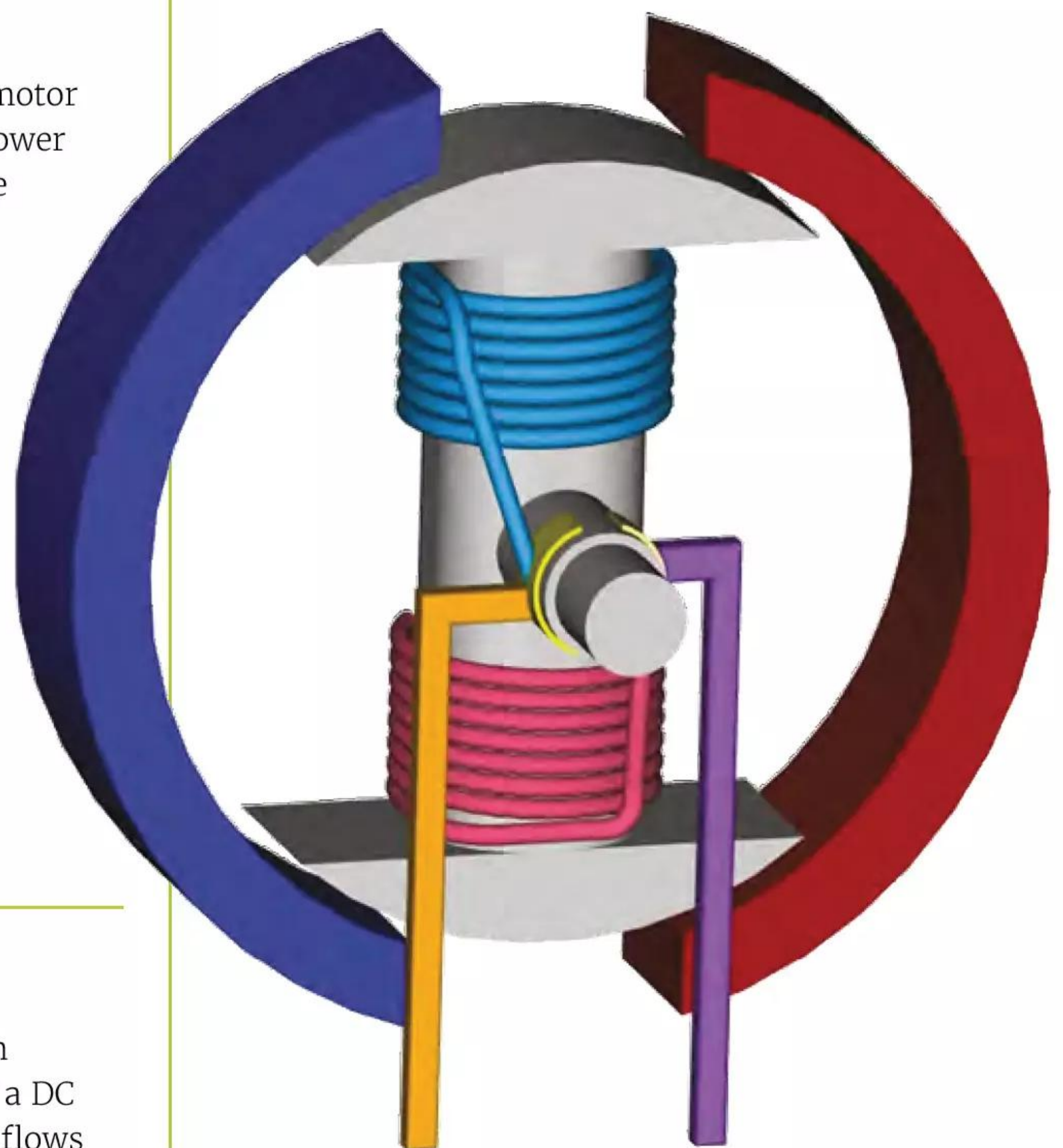

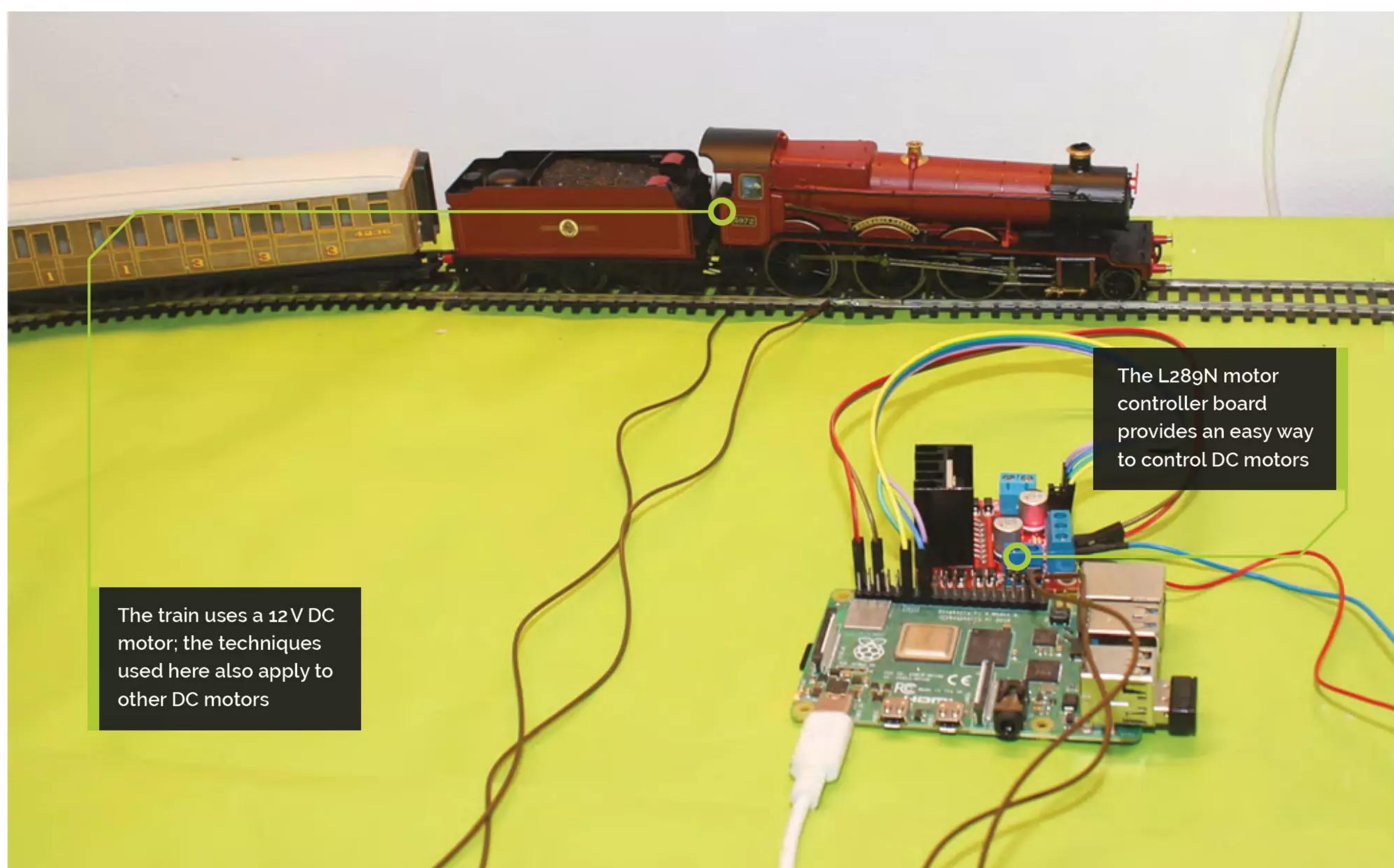

### 03 H-bridge

Applying a DC voltage to the motor will result in the motor moving in one direction. If you want to change direction, you need to reverse the polarity. This is where an H-bridge circuit comes in. The **Figure 2** diagrams show how this can be achieved. The diagrams show four switches which are arranged in an H shape. In the first example, S1 and S4 are closed, which results in the positive supply to the left side and ground to the right. In the second diagram, switches S2 and S3 are closed, which results in the positive side at the right and ground to the left.

### 04 L298N motor driver

The diagrams show physical switches, but it will normally be some kind of electronic switch, such as a MOSFET. Rather than using individual components, these are normally included in an H-bridge integrated circuit or in a motor controller. A useful driver is the L298N, which can be used to drive two DC motors.

A further advantage to using an integrated circuit, rather than individual MOSFETs, is that it prevents two MOSFETs on the same side being turned on together. For example, if both S1 and S3 were turned on, it would result in a short circuit.

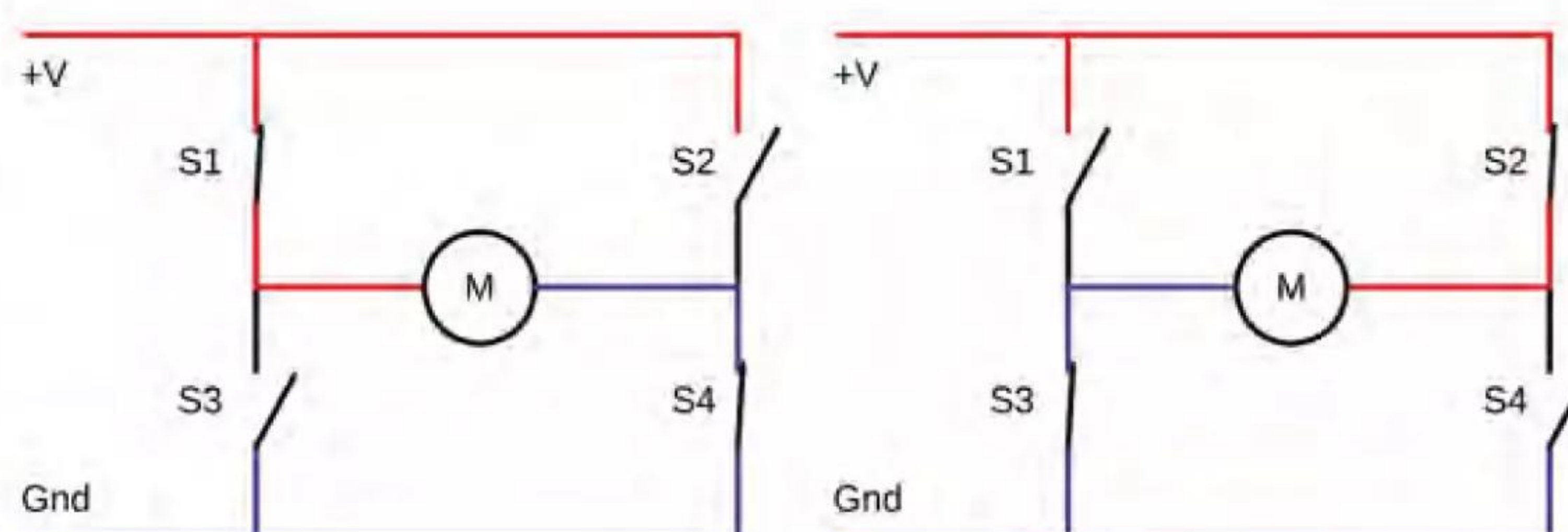

### 05 L298N PCB

One disadvantage of the L298N is that it has an unusual pinout which makes it difficult to use on a breadboard. Fortunately, they are available pre-soldered onto a mini-PCB, which makes them easy to connect to a Raspberry Pi. A photo of an example PCB is shown in **Figure 3**.

The power supply for the railway will normally be 12V, although some larger gauge models may need a higher voltage. An external power supply should be connected to the 12V connector. The board

**Figure 3:** The L298N H-bridge IC is available soldered to a small PCB. Some boards are arranged differently, but provide a similar circuit

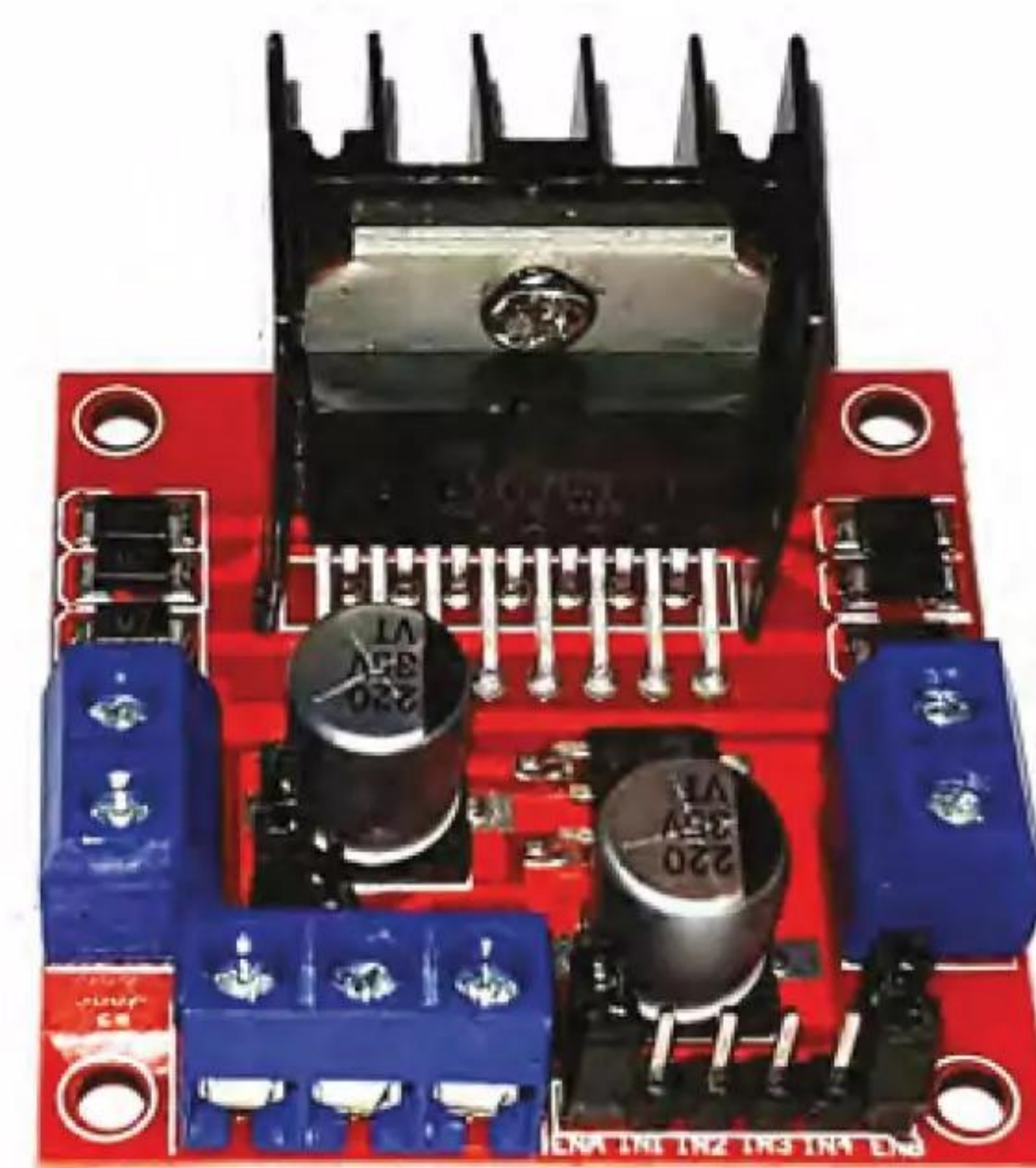

**Figure 2:** How an H-bridge reverses polarity. Shown here with simple switches, this is within the H-bridge IC

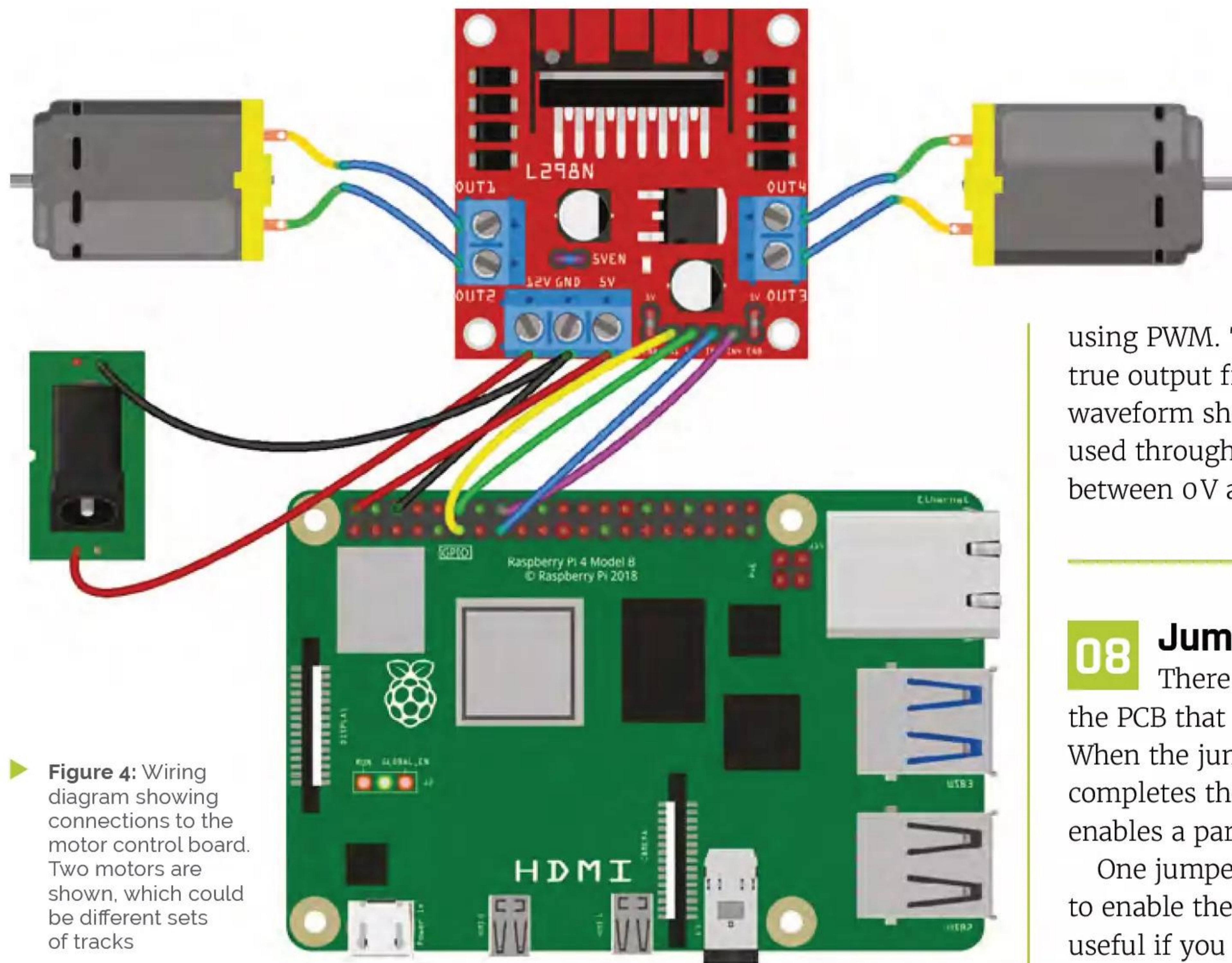

► **Figure 4:** Wiring diagram showing connections to the motor control board. Two motors are shown, which could be different sets of tracks

also needs a 5V supply which can be provided from a Raspberry Pi power supply or from the 12V supply using an on-board jumper.

## 06 Motor direction

The L298N needs two inputs for each motor. In effect, input 1 controls S1 and S3 and input 2 controls S2 and S4. To move the motor in the forward direction, input 1 should be high and input 2 should be low. To reverse the direction, input 1 should be low and input 2 should be high. These should be connected to the GPIO pins 17 and 18. The outputs 1 and 2 go to the motor.

The wiring diagram is shown in **Figure 4**. A motor has been used on the diagram; for a model railway, however, that will go through the track before reaching the motor in the locomotive.

## 07 Motor speed control with PWM

The speed of a DC motor is controlled by changing the voltage across it. A higher voltage will result in the motor spinning faster. It's not possible to provide a true analogue voltage with this setup, but we can create a changing voltage by rapidly switching the output on and off; this uses

a technique known as pulse-width modulation (PWM).

The diagram in **Figure 5** shows an example of how a Raspberry Pi can create a changing output voltage using PWM. The waveform on the top shows the true output from a Raspberry Pi and the bottom waveform shows the effective output voltage. When used through the H-bridge, this will give an output between 0V and the supply voltage (e.g. 12V).

## 08 Jumpers on the PCB

There are optional jumpers included on the PCB that are used to enable certain features. When the jumper is placed across the headers, it completes the circuit between those points and enables a particular feature.

One jumper is shown as 5VEN, which is used to enable the on-board 5V power supply. This is useful if you don't have a 5V supply elsewhere. Since the 5V power supply is taken from Raspberry Pi instead, that jumper should be removed.

▼ The supplied code provides a simple interface. See the more advanced version for a graphical interface which can control two trains.

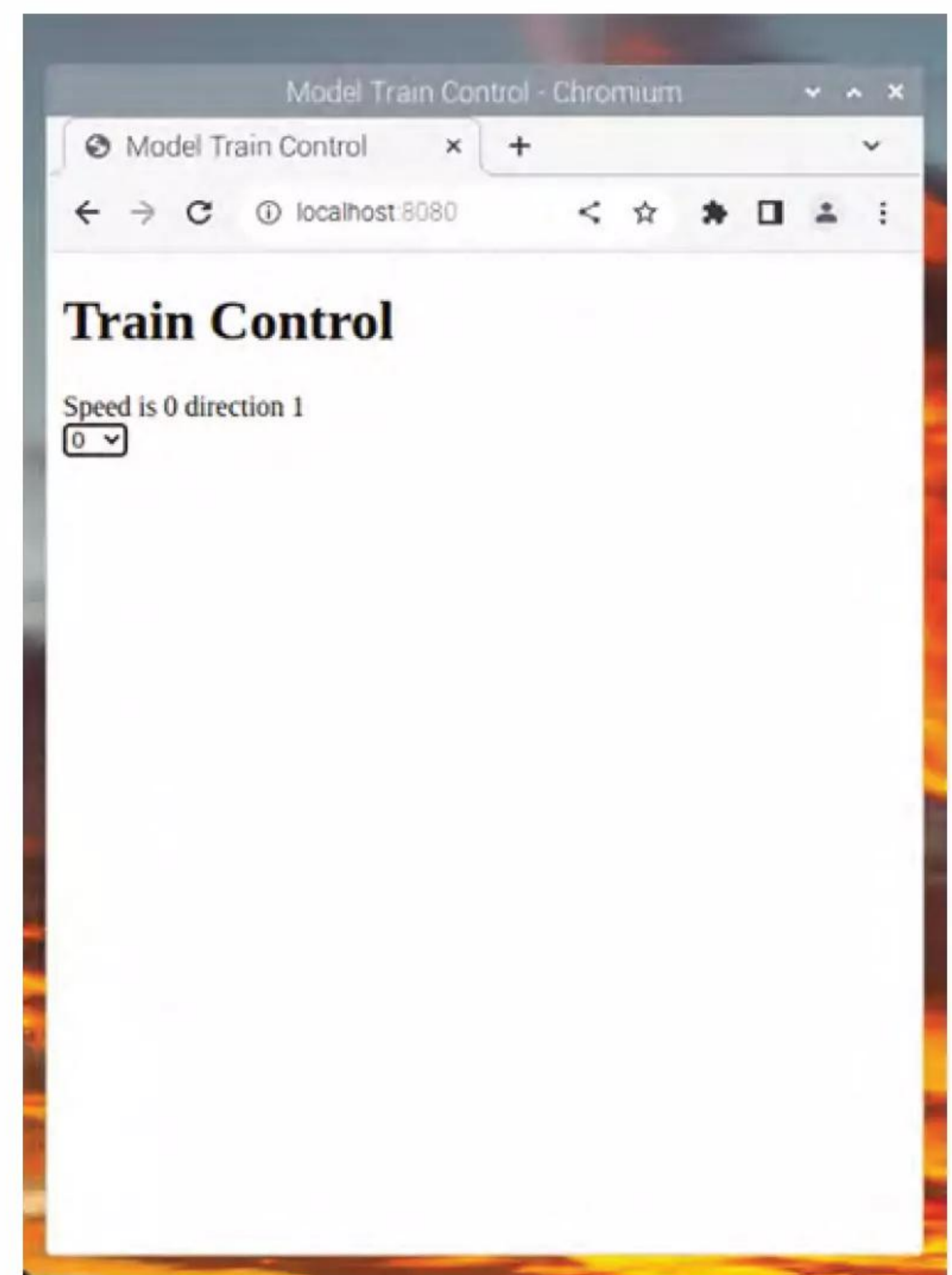

## Top Tip

### IP address

The application can be accessed as localhost from your Raspberry Pi. To connect using other devices (such as a phone), you will need to know the IP address.



Two are labelled as ENA and ENB to enable the H-bridge driver. They can be used as an input to provide speed control, but this is done using PWM on the IN pins instead, so those jumpers should be left in place, or the pins connected to 5V.

## 09 Controlling the motors using Python GPIO Zero

The motors can be controlled from Python using the GPIO Zero library, which is installed as standard. To include the library, use the entry:

```
from gpiozero import Motor
```

Then create an instance of the motor using the entry:

```
motor = Motor (forward=17, backward=18)
```

The numbers are the GPIO port numbers used to connect between your Raspberry Pi and the motor controller. To move the motor (in this case model train) forward, use:

```
motor.forward(speed=1)
```

The speed should be a value between 0 and 1, representing the PWM duty cycle. To reverse the direction, use:

```
motor.backward(speed=1)
```

## 10 Creating a web server with Bottle

Bottle is a web framework for Python. It provides a way to create a web application

using only a few lines of code. First, it needs to be installed onto your Raspberry Pi from the terminal using:

```
sudo apt install python3-bottle
```

To create the web application, include the following command near the bottom of the Python code file:

```
run (host='0.0.0.0', port=8080, debug=True)
```

Setting the host address to 0.0.0.0 will allow you to connect from any other device on the local network. The port 8080 is not the standard for a web server, which is normally 80, but allows

“ The speed of a DC motor is controlled by changing the voltage across it. A higher voltage will result in it spinning faster ”

the application to be run without needing root permissions. If using a browser on your Raspberry Pi, you can access the application using the address **http://localhost:8080**.

## 11 The Bottle route decorator

The route decorator is used to handle the incoming requests to the application. You will normally want a route for the home page which uses `@route('/')`, followed by the function definition. In this example, a static HTML file is returned.

## Top Tip

Different L289N driver boards

There are different PCBs available that may have slightly different features. Check the datasheet for the board for more details

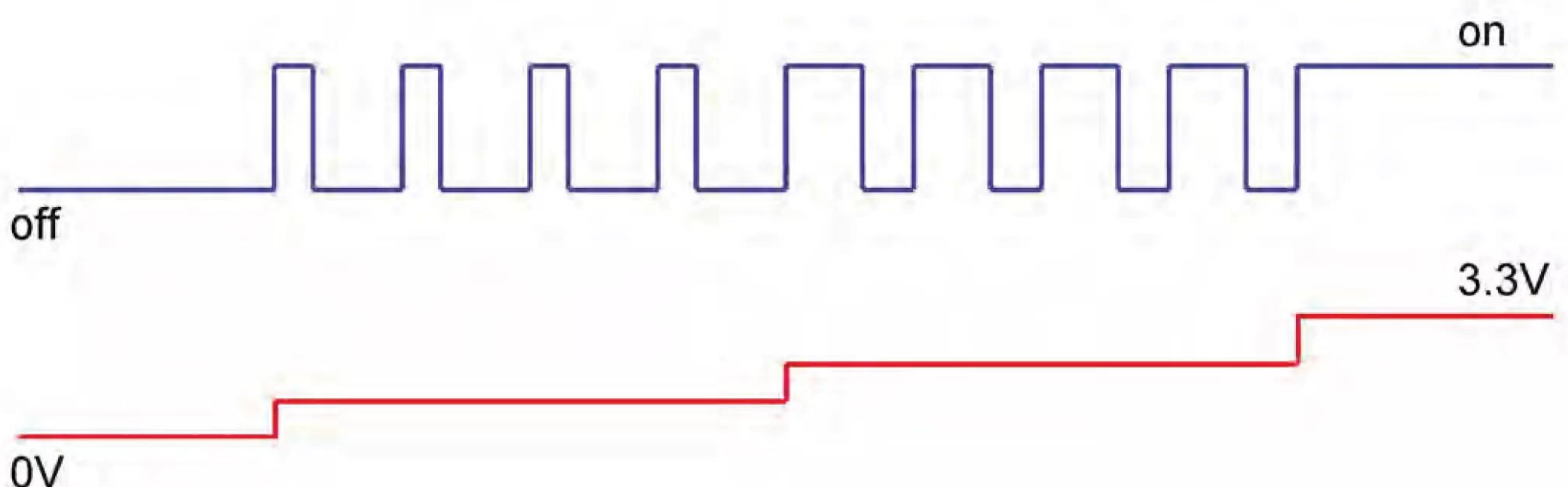

▼ **Figure 5:** Waveforms showing how a PWM signal turns the output voltage on and off to provide an equivalent of an analogue voltage

For sending instructions to the train, there is a second route decorator based on a control instruction. The `control_train` function then uses `request.query` to read the parameters in the query string. From a security perspective, it is important to check that the values provided by the user are valid before they are used to call the appropriate motor methods.

## 12 HTML page

An HTML file is also needed to provide the web interface to the user. The page uses the jQuery library so that commands are sent directly to the application when a new speed is selected. Both the

jQuery and HTML files should be downloaded from the GitHub repository at [magpi.cc/rpitrain](https://github.com/magpi/rpitrain) and stored in the **public** folder.

The example HTML file is a minimal file that allows for speed change, but a more advanced version is available from the alternative GitHub repository at [magpi.cc/ptrailway](https://github.com/magpi/ptrailway).

With the code being written in Python, it is possible to use this as a basis for model railway automation such as automatically stopping the train as it enters the station. [M](#)

**DOWNLOAD  
THE FULL CODE:**

 [magpi.cc/rpitrain](https://magpi.cc/rpitrain)

# train.py

> Language: Python

```

001.  #!/usr/bin/python3
002.  from gpiozero import Motor
003.  from bottle import route, run, static_file,
    request
004.
005.  motor = Motor (17, 18)
006.
007.  @route('/')
008.  def server_home ():
009.      return static_file ('index.html',
    root="/opt/train/public/")
010.
011.  # public files
012.  # *** WARNING ANYTHING STORED IN THE PUBLIC
    FOLDER WILL BE AVAILABLE TO DOWNLOAD
013.  @route ('/public/<filename>')
014.  def server_public (filename):
015.      return static_file (
    filename, root="/opt/train/public")
016.
017.  @route('/control')
018.  def control_train ():
019.      #getvar_dict = request.query.decode()
020.
021.      # get speed & direction
022.      speed = int(request.query.speed)
023.      direction = int(request.query.direction or 1)
024.      # check speed is valid
025.      if (speed >= 0 and speed <= 10 and direction
    >= -1 and direction <= 1):
026.          command_speed = speed / 10
027.          train_set_speed (
    command_speed, direction)
028.          return "Speed is {} direction {}".format(
    speed, direction)
029.      else:
030.          return "Invalid command"
031.
032.  def train_set_speed(speed, direction):
033.      if direction == 0:
034.          motor.stop()
035.      elif direction == 1:
036.          motor.forward(speed)
037.      else:
038.          motor.backward(speed)
039.
    run (host='0.0.0.0', port=8080, debug=True)

```

# Expand your Raspberry Pi

Stackable expansion boards for Raspberry Pi

## ADC Pi

8 channel analogue to digital converter

## Serial Pi Plus

RS232 serial interface for the Raspberry Pi

## IO Pi Plus

32 channel GPIO controller.

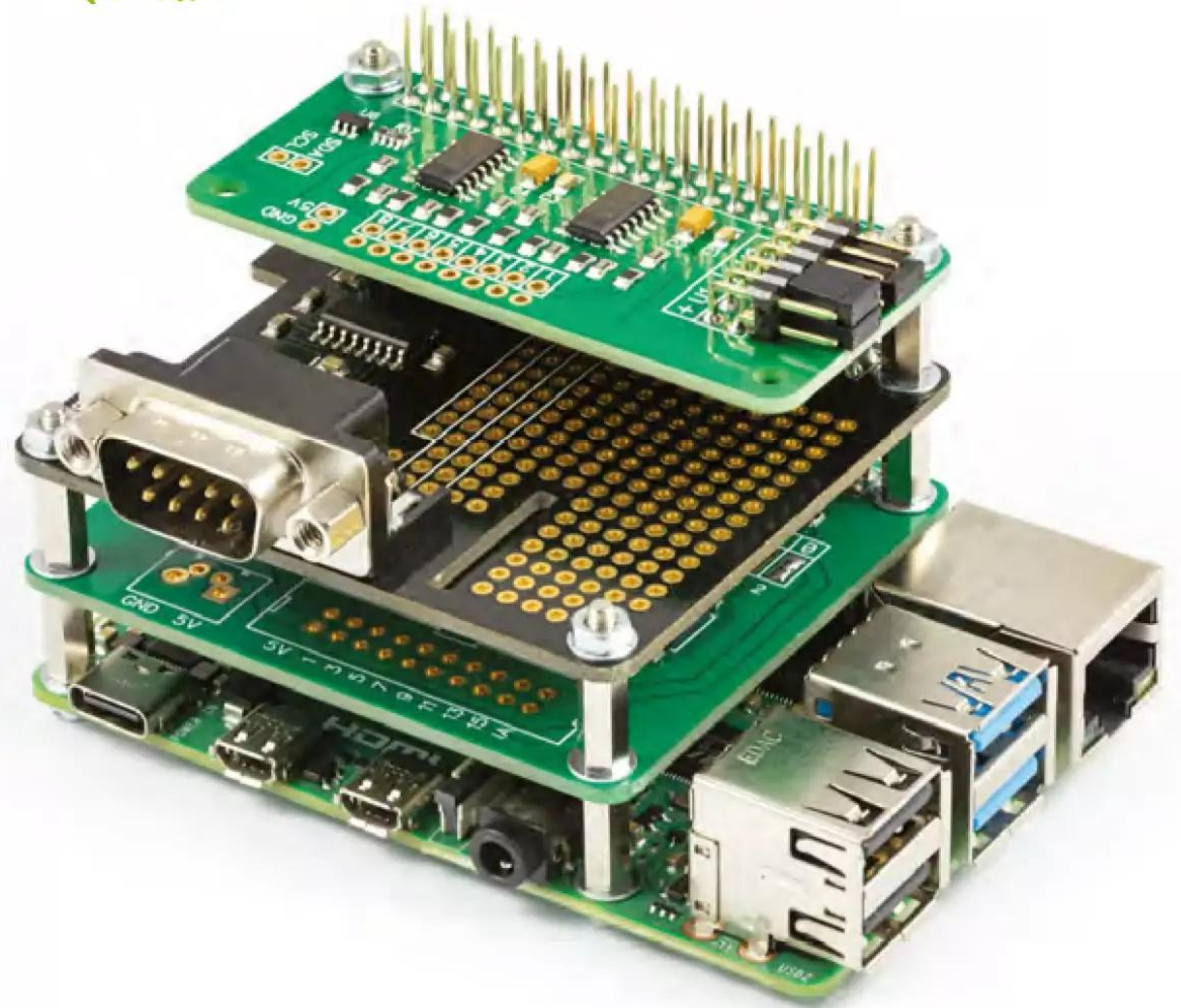

**AB**electronics **UK**

[www.abelectronics.co.uk](http://www.abelectronics.co.uk)



A wireless hydrometer and thermometer that connects to your Raspberry Pi

Free international shipping with checkout code:

SHIP-FREE-INTL

shop now at [tilthydrometer.com](http://tilthydrometer.com)



# Camera Module: Understanding camera modes



**David Plowman**

David is an engineer at Raspberry Pi with a special interest in camera software and algorithms, and image processing hardware.

[raspberrypi.com](http://raspberrypi.com)

Take control of your Raspberry Pi Camera Module and how it captures images

**C**ameras deliver sequences of images and we can control certain aspects of how they are delivered, like the exposure time or frame rate. However, the limits of these parameters are all governed by the mode in which the camera is operating. For example, the current camera mode may have a maximum frame rate that it will allow, and therefore any attempt to ask for a higher frame rate will fail unless a new camera mode is selected beforehand.

Selecting a new camera mode is a relatively expensive operation. It requires reprogramming much of the sensor's internal configuration. Therefore, it cannot happen while the camera is running and delivering images. Instead, the camera must be stopped completely, reconfigured into the chosen mode, and finally restarted. This whole process can easily take several hundreds of milliseconds.

## Camera mode range

The range of available camera modes is determined by the driver for the image sensor. To all intents and purposes, this list of modes is fixed. Adding new modes is a quite technical procedure that will

require detailed knowledge of the internals of the image sensor (probably from the manufacturer) and also of Linux kernel programming.

## Image resolution

A sensor has a 'native' resolution, which corresponds to the maximum image resolution that the sensor can provide. However, we can usually configure the sensor to output images of different sizes, as follows.

## Cropping

Instead of reading out the sensor's full array of pixels, giving us the 'native' resolution, we can normally configure a sensor to read out only a window, or 'crop', from within the entire array of pixels. This limits the field of view - you don't get the full image that the sensor could have delivered - but in return you may be able to read the image out more quickly, giving a higher maximum frame rate. When we describe the 'crop' associated with a camera mode, we measure it in units of the full native sensor resolution, which we'll demonstrate in one of the diagrams.

## Binning

Many sensors have a feature where every little  $2 \times 2$  block of pixels is averaged to create a single output pixel, and this process is known as 'binning'. The end result is an image with half the height and half the width of the full sensor resolution (see **Figure 1**).

Binned modes produce images with lower noise (because of the averaging). As with cropping, they are able to run at significantly higher frame rates. Binned modes also give applications the possibility to deal with fewer pixels in every image, which is often helpful in preview or video use cases.

▼ **Figure 1** Cropping and binning to create a smaller output resolution

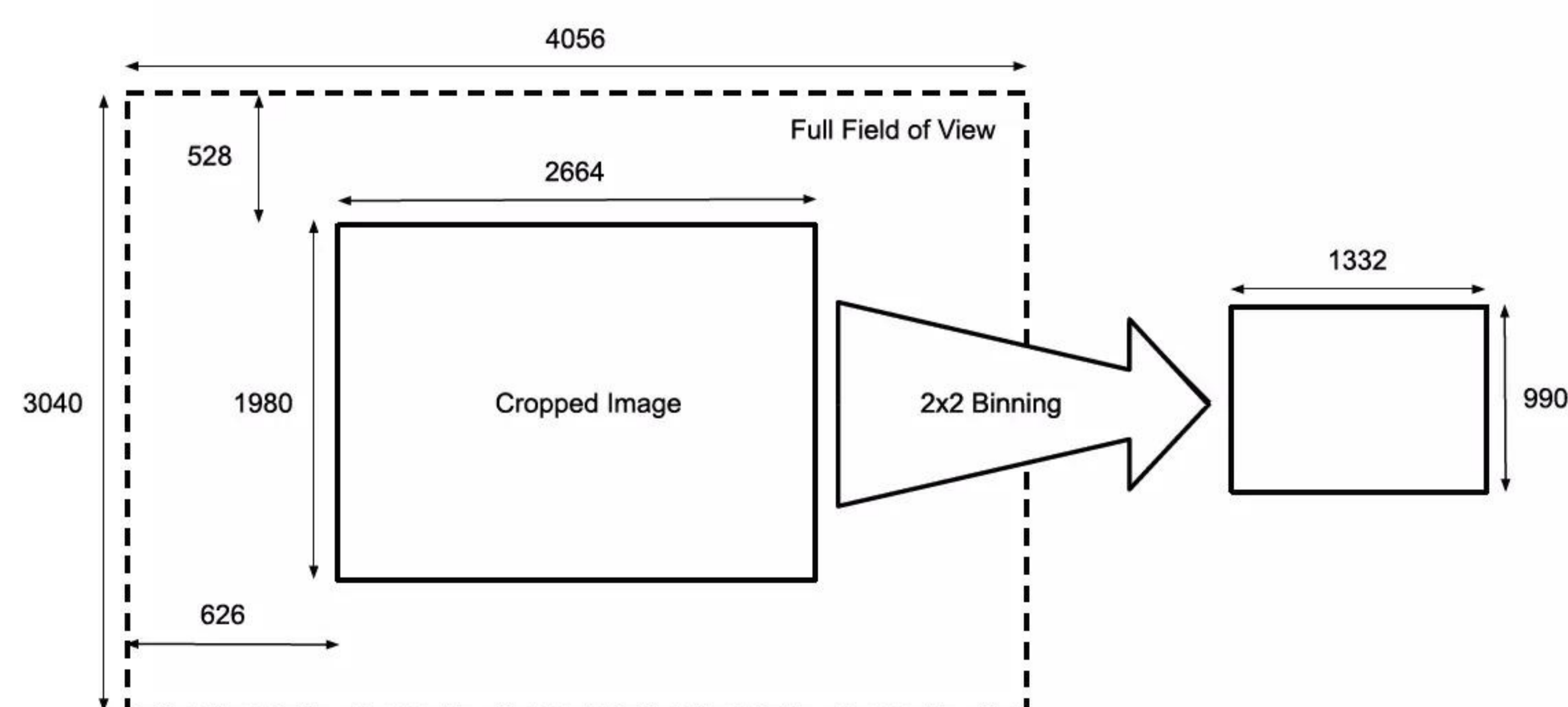

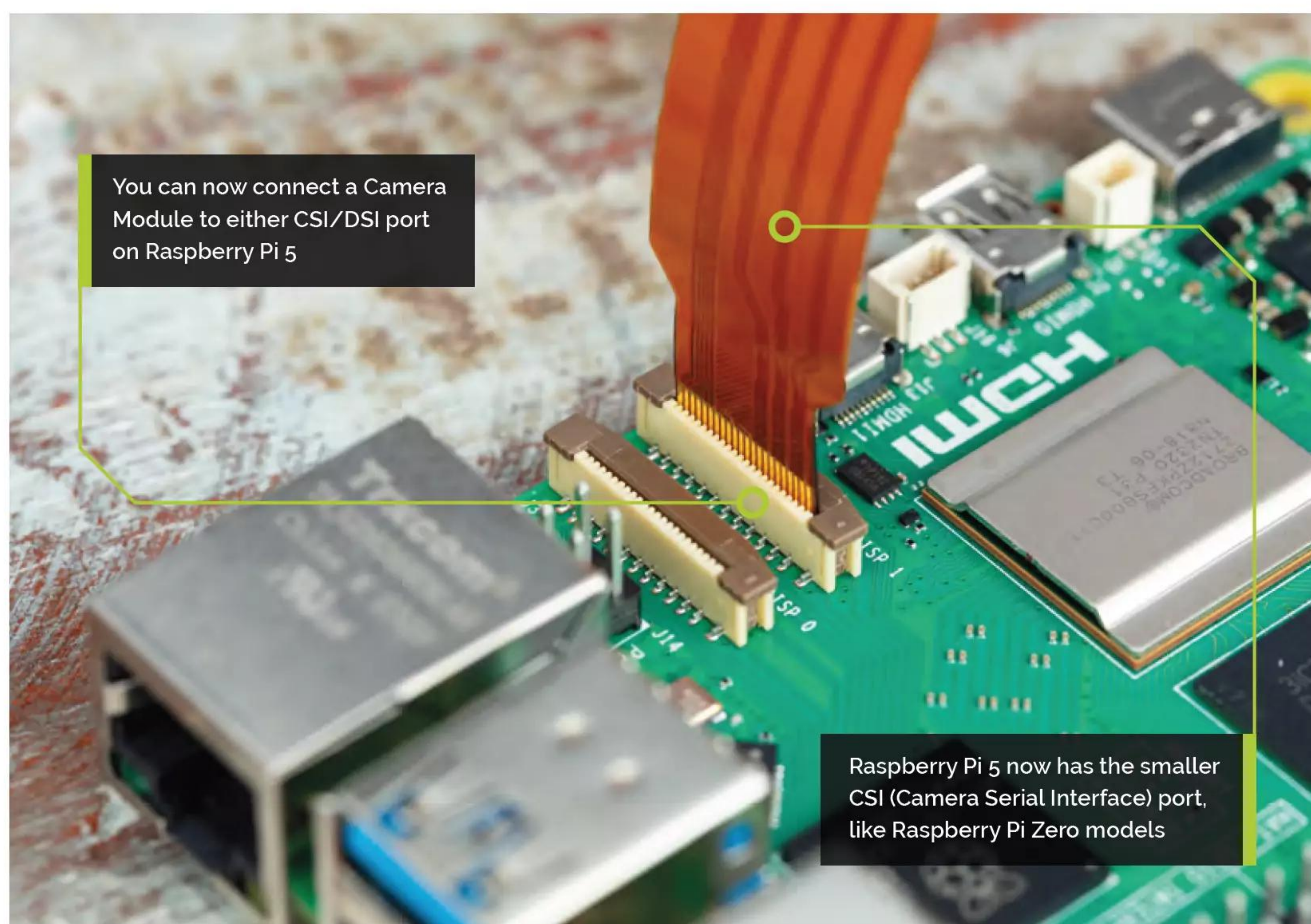

Very similar to binning is ‘skipping’. This too turns blocks of  $2 \times 2$  pixels into a single output pixel, though simply by dropping three of them. Therefore it doesn’t benefit from the improved noise levels.

The process of turning  $2 \times 2$  pixel blocks into a single output pixel is referred to as ‘ $2 \times 2$  binning’. Although less common, some sensors may even support  $4 \times 4$  binning modes that involve both  $2 \times 2$  binning and  $2 \times 2$  skipping.

Sensors normally also allow both cropping and binning, and we’ll look at an example of this later.

### Bit depth

The camera mode also determines the number of bits in every pixel that it reads out. Although the output images from the camera system normally use 8-bit pixels, the values that we read from the image sensor are normally larger, with typically 10 or 12 bits. Again, the sensor will normally have a native bit depth, although a camera mode may allow you to read out fewer. Here too the benefit would be in achieving slightly higher frame rates.

### Other special modes

Beyond this, certain cameras may have special modes that support less common or particularly advanced features. One such example is the Camera Module 3, which has a special High Dynamic Range (HDR) mode that merges multiple pixels together to create an HDR image.

### Finding out the available modes

The easiest way to find out what camera modes are available is to open a Terminal window and type:

```
libcamera-hello --list-cameras
```

This will list the cameras attached to the system (usually just one) and, for each, it will list the available camera modes. For the HQ Camera, for example, it will return:

```
Available cameras
-----
0 : imx477 [4056x3040 12-bit RGGB] (/base/
soc/i2c0mux/i2c@1/imx477@1a)
    Modes: 'SRGGB10_CSI2P' : 1332x990 [120.05
fps - (696, 528)/2664x1980 crop]
          'SRGGB12_CSI2P' : 2028x1080 [50.03
fps - (0, 440)/4056x2160 crop]
                                     2028x1520 [40.01
fps - (0, 0)/4056x3040 crop]
                                     4056x3040 [10.00
fps - (0, 0)/4056x3040 crop]
```

We can interpret this as follows:

1. There is just a single camera, numbered as camera 0. This line also identifies it as an imx477 (the sensor in the HQ Camera), with a native resolution of  $4056 \times 3040$  pixels, and a native pixel depth of 12 bits.

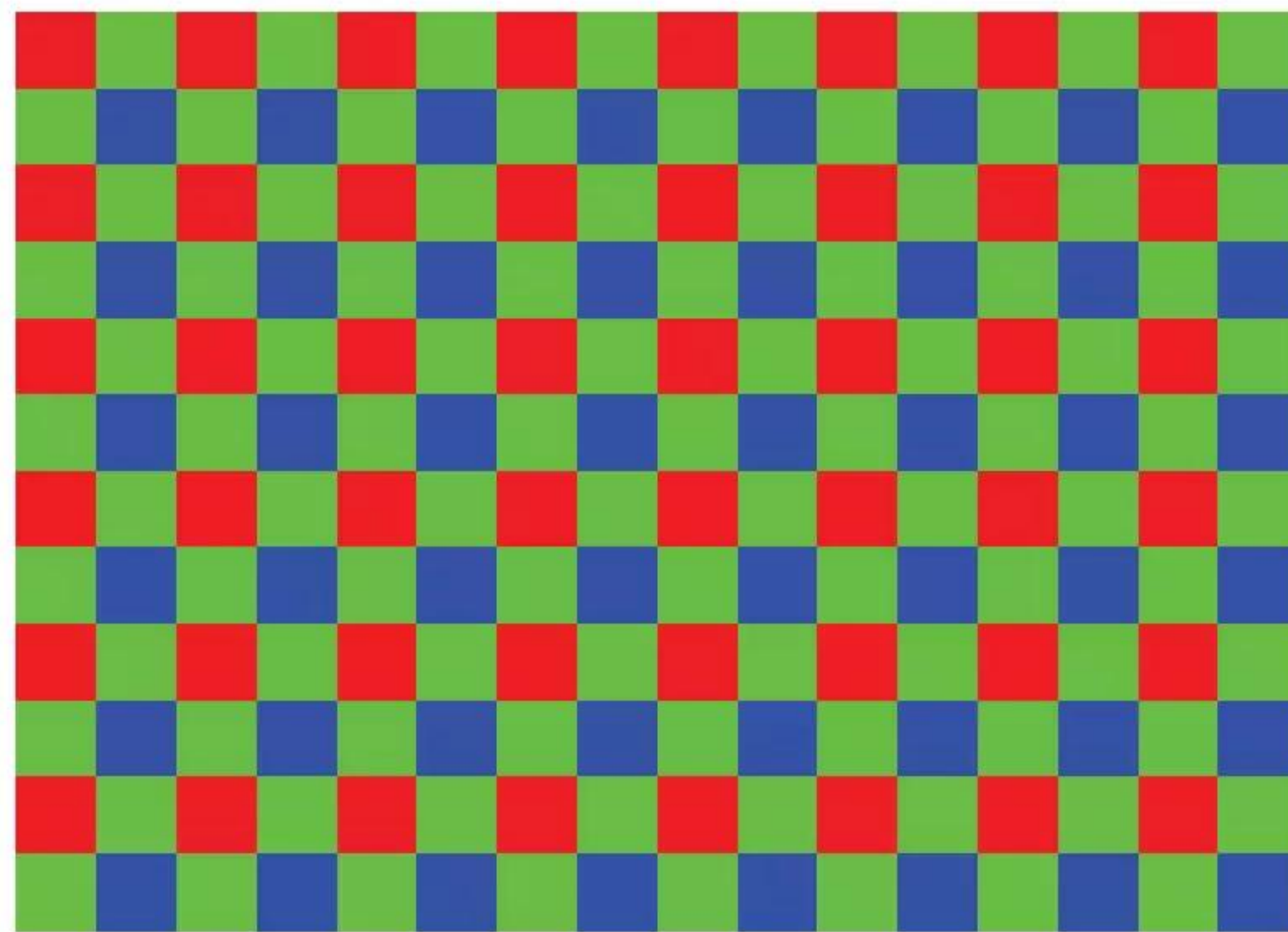

► **Figure 2** A Bayer pattern – every pixel is only red, green or blue

2. Next, it tells us that there is just one ‘SRGGB10\_CSI2P’ mode. This is the ‘pixel format’. Most of it isn’t too important, but the number 10 here tells us that this is a 10-bit mode, rather than the more usual 12-bit modes below. It’s clear this has been chosen to give us a maximum of just over 120 frames per second.
3. After the pixel format, every mode lists the output resolution for that camera mode. If you ask your camera application for images larger than this, while using this mode, then it will have to upscale them.
4. Next we have three ‘SRGGB12\_CSI2P’ or 12-bit modes, with frame rates ranging from about 50 fps down to about 10 fps for the full-resolution version.
5. At the end of each line we have the crop for that mode. This is given in the form (x\_offset, y\_offset)/width × height. So the first mode (the 10-bit one) reads a 2664×1980 rectangle out of the native 4056×3040 image but offset with its top left corner at (696, 528) in the native image. A quick calculation that  $4056 = 2 \times 696 + 2664$  should confirm that we’re reading out the central portion of the image (and the same again in the vertical axis). Note how this camera mode involves both cropping and binning.
6. Finally, we note, again for the 10-bit mode, that the crop window of 2664×1980 is exactly twice the output image size, confirming that this is a 2×2 binning mode.
7. Note also how the 2028×1080 mode is very similar to the 2028×1520 mode – same width, both using 2×2 binning – but the slightly shorter image height allows a higher frame rate. It’s clearly intended to allow applications to record 1080p50 videos.

## Top Tip

### Full field of view

When the two crop offsets (x\_offset and y\_offset above) are both zero, then this is a full field of view mode.

## Which mode to use?

This is a surprisingly difficult question. Different camera modes have different features and advantages, and there’s no one-size-fits-all method to decide which mode to use based on, for example, the final output image size that an application has requested.

For instance, is the application happy to accept some upscaling? Or would it rather use the highest resolution camera modes, and downscale the image, to get better image quality?

Does an application prioritise getting the widest possible field of view from the image sensor, or would it be happy to sacrifice the field of view in return for faster frame rates?

Whilst libcamera-apps will attempt to make a reasonable choice for you based on the arguments provided, it won’t always be right. For this reason, it’s possible for the user to override this selection process and choose exactly which camera mode to use.

“ It’s possible for the user to override the selection process and choose exactly which camera mode to use ”

## Selecting a camera mode explicitly

The libcamera-apps have a number of mode-related command-line parameters that allow you to select exactly which camera mode you want to use. They all take the form ‘width:height:bitdepth:packing’, where:

- **width** is the output width of the camera mode
- **height** is the output height of the camera mode
- **bitdepth** is the bit depth of the camera mode
- **packing** is the letter P (‘packed’) or U (‘unpacked’). Packed formats will be preferable for most people as they use less memory bandwidth and are therefore more efficient, though users who want access to the raw pixel data from the sensor (beyond the scope of this guide) may prefer unpacked formats.

The command-line parameters are named as follows:

- **libcamera-hello** accepts the parameter `--viewfinder-mode mode` where mode is as defined above.

- **libcamera-vid** accepts the parameter `--mode mode` with mode as defined above.
- **libcamera-still** accepts both the parameters `--viewfinder-mode mode` which defines the camera mode for the preview phase, and `--mode mode` which defines the camera mode for the actual still image capture.

For example, using an HQ Camera:

```
libcamera-vid -o 1080p50.h264 --mode
2028:1080:12:P --framerate 50
```

...will record a 1080p resolution at 50fps. We know it can reach this frame rate because we have explicitly chosen a camera mode that is capable of this. The camera mode, outputting a larger image than 1920×1080, also guarantees that no upscaling is happening.

### Raw images and camera tuning

We've mentioned how camera modes define the resolution and format of the 'raw pixels' that are read from the image sensor. But what exactly are these 'raw pixels'?

The pixels that we obtain from the sensor require a large amount of processing to turn them into viewable images. For a start, each pixel records only one colour – red, green, or blue – instead of all three. This kind of image is often referred to as a Bayer image, named after Bryce Bayer who pioneered their use at Kodak. Although other forms of image sensor exist, so-called Bayer sensors remain very popular because they work well and are cost-effective (see **Figure 2**).

You're also now in a position to understand why the IMX477 was described by `libcamera-hello --list-cameras` as an RGGGB sensor. It's because it's made up of pairs of rows where every Red-Green pixel row is followed by a Green-Blue row.

Not only do the 'missing' colours have to be calculated (or interpolated), but a whole host of other corrections have to be applied. This includes fixing any stuck pixels, reducing noise levels, and making the brightness levels and colours look correct. Finally, the image needs to be delivered in the correct resolution and format to the end-user or application.

Most of the time, all we want is the fully processed final image that comes out of the camera system, but there are certainly applications – sometimes scientific in nature, or for professional photographers – where access to the raw sensor data can be useful. We can even

capture the raw sensor data in a DNG file (Digital NeGative). For example:

```
libcamera-still --raw -o image.jpg
```

...will save the raw file **image.dng** alongside the requested JPEG file **image.jpg**. You would need special software tools to use or convert these DNG files, which lie beyond the scope of this guide.

### Tuning files

Finally, it's worth noting that we actually have many choices in how we turn the raw image into a final picture. Raspberry Pi provides a default 'tuning file' which supplies the various parameters that control this process, and you can look at them in the file **imx477.json**, which should be available on Raspberry Pi OS's file system (usually in `/usr/share/libcamera/ipa/rpi/vc4`). This is a JSON-formatted text file for the IMX477 sensor (in the HQ Camera) with each named block of parameters controlling one specific aspect of the process. Where the default camera tuning does not suit a user's applications, we would encourage them to develop their own camera tuning files, and to consider contributing them back to the wider Raspberry Pi user community. Help and documentation are available for those who would like to get involved: [magpi.cc/cameradatasheet](https://magpi.cc/cameradatasheet). 

▼ Connecting Raspberry Pi cable to Camera Module

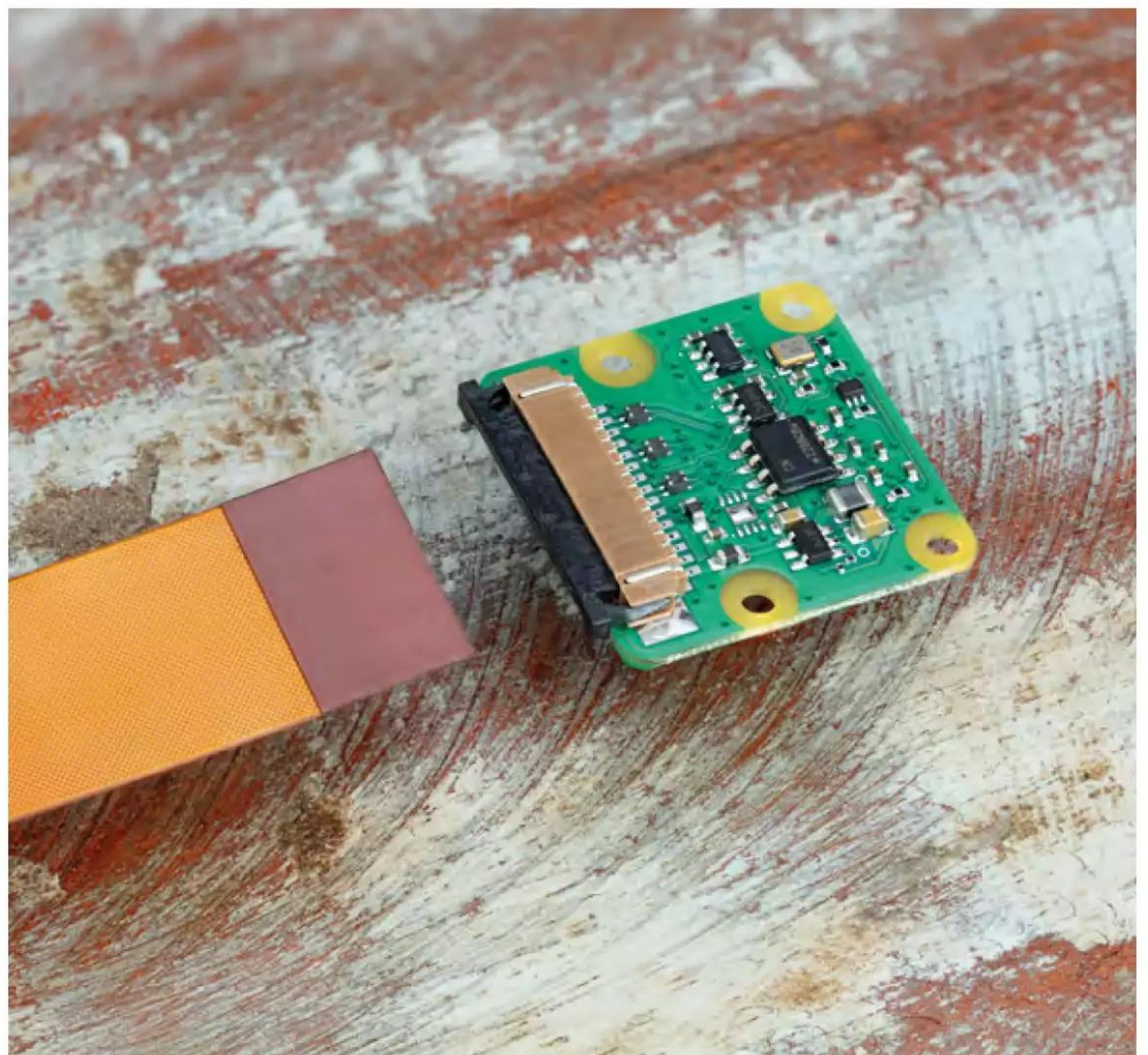

# Discover variables with Python

Discover how to keep track of things in Python. Store, use and reuse strings, numbers, and other values with variables



**Lucy Hattersley**

Lucy is editor of *The MagPi* and has been coding since somebody pushed her nose into a BBC Micro at school.

[magpi.cc](http://magpi.cc)

**V**ariables are your friendly all-purpose Python containers. Like digital Tupperware, they are used to contain a wide range of different values. The big two are strings (words and characters) and integers (numbers).

There are lots of other types of variables as well. We'll get to them in due course, but for now let's take a look at what a variable is.

Open up Thonny IDE and click in the Editor (the top part of the screen) and enter the code from the `foobar.py` listing (overleaf).

```
foo = 5 # foo is a variable that contains the value 5
bar = 9 # bar is a variable that contains the value 9
foobar = foo + bar # foobar is a variable that contains the sum of foo and bar
# print the value of foobar
print(f"The variable 'foobar' contains the
```

**Figure 1** The anatomy of a variable statement. Here, the value 5 is assigned to the variable 'foo' and can be retrieved at any time

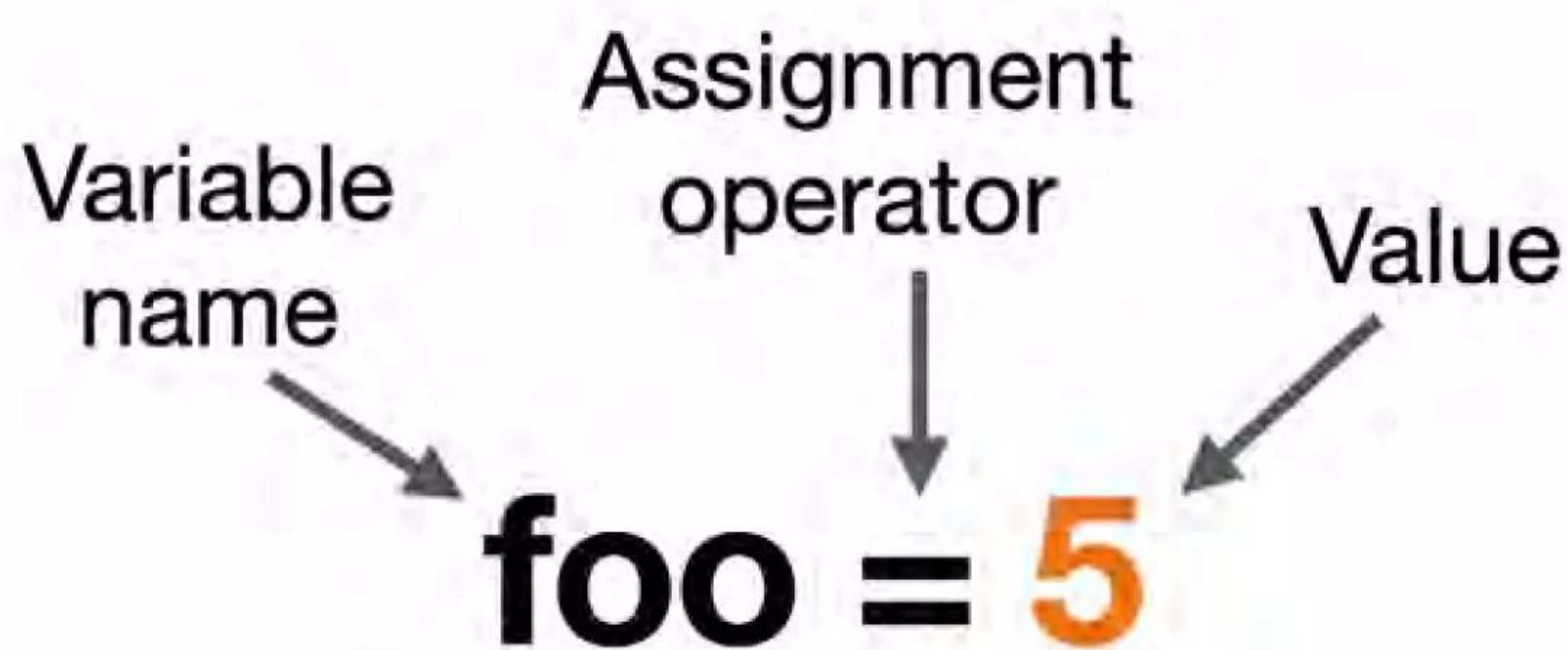

```
sum of 'foo': {foo} and 'bar' {bar} which is: {foobar}")
```

Click Save and call the program 'foobar.py'. Now click Run. The Shell (at the bottom of the screen) will display:

```
>>> %Run foobar.py
The variable 'foobar' contains the sum of 'foo': 5 and 'bar' 9 which is: 14
```

Let's unpick this. The labels `foo`, `bar`, and `foobar` are our three variables. The first two represent two containers that contain different numerical values and the third is the combined sum of the two variables.

Imagine you have three cups and a label printer. You put five marbles inside one cup and label it 'foo'. The second cup contains nine marbles and you label it 'bar'. You then count the number of marbles in `foo` and `bar` and put 14 marbles in a 'foobar' cup. You now have three cups:

- `foo` contains 5 marbles
- `bar` contains 9 marbles
- `foobar` contains 14 marbles

There are three parts to the statement `foo = 5`. The first, `foo`, is the 'variable name'; the second, `=`, is the 'assignment operator'; and the number `5` is the 'value'. See **Figure 1**.

## Name things correctly

In Python, it is helpful to learn the precise names for things. So that when you are looking for help, or describing a problem, you are using accurate language.

When you create the `foobar` variable on line 3, you use the `foo` and `bar` variables in the statement



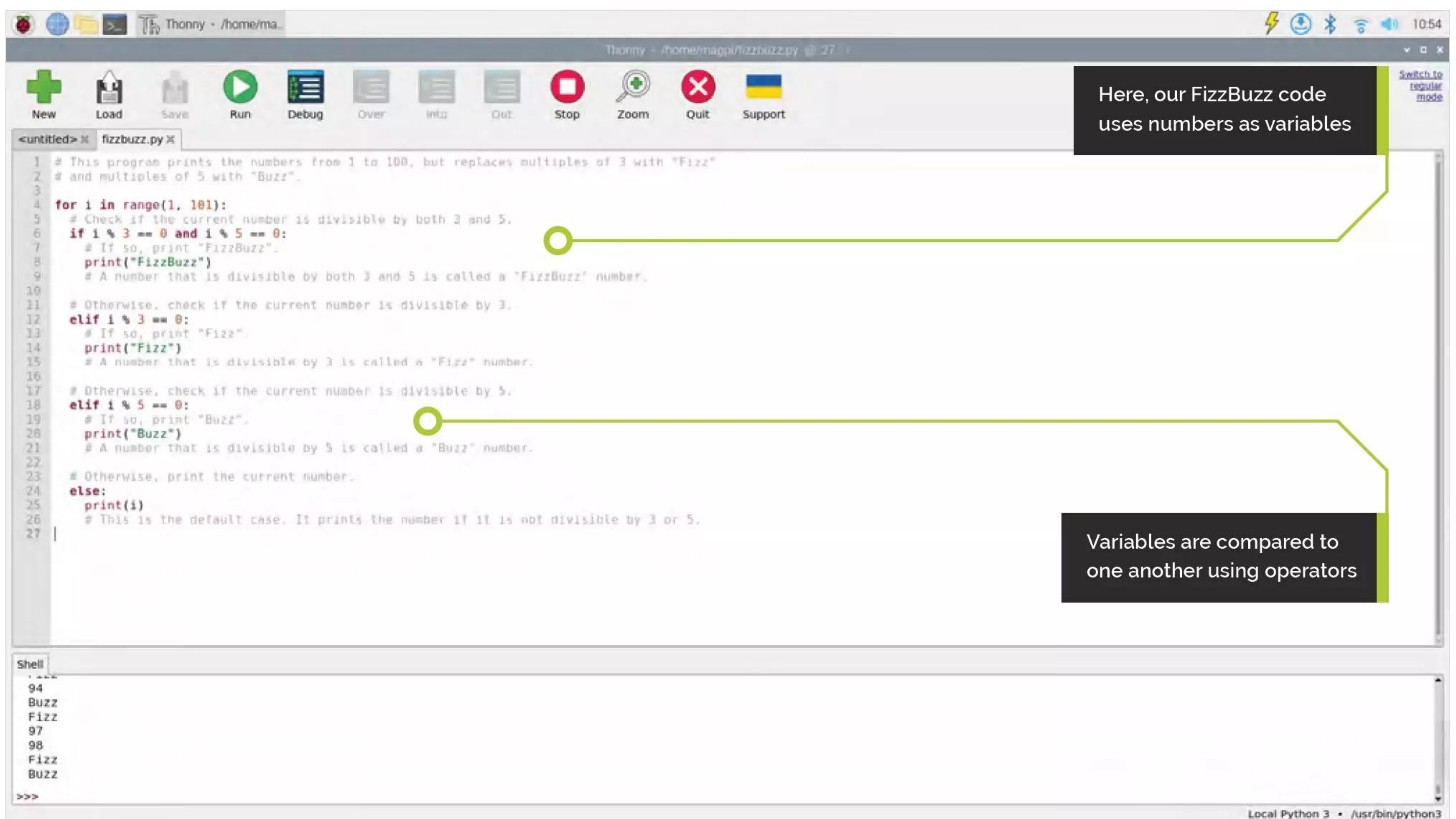

```

1 # This program prints the numbers from 1 to 100, but replaces multiples of 3 with "Fizz"
2 # and multiples of 5 with "Buzz".
3
4 for i in range(1, 101):
5     # Check if the current number is divisible by both 3 and 5.
6     if i % 3 == 0 and i % 5 == 0:
7         # If so, print "FizzBuzz".
8         print("FizzBuzz")
9         # A number that is divisible by both 3 and 5 is called a "FizzBuzz" number.
10
11 # Otherwise, check if the current number is divisible by 3.
12 elif i % 3 == 0:
13     # If so, print "Fizz".
14     print("Fizz")
15     # A number that is divisible by 3 is called a "Fizz" number.
16
17 # Otherwise, check if the current number is divisible by 5.
18 elif i % 5 == 0:
19     # If so, print "Buzz".
20     print("Buzz")
21     # A number that is divisible by 5 is called a "Buzz" number.
22
23 # Otherwise, print the current number.
24 else:
25     print(i)
26     # This is the default case. It prints the number if it is not divisible by 3 or 5.
27

```

Here, our FizzBuzz code uses numbers as variables

Variables are compared to one another using operators

```

Shell
94
Buzz
Fizz
97
98
Fizz
Buzz
>>>

```

“ When you assign a value to a variable, it then contains that value until you change it or delete the variable ”

`foo + bar`. As you would expect, this sums up the values in the two variables and assigns it to our third, `foobar`, variable. See **Figure 2**.

In this instance, the `+` symbol is an ‘addition operator’ (notice the similarity in name to our ‘assignment operator’). There are lots of other operators in Python and we will come across them in due course. When you assign a value to a variable, it then contains that value until you change it or delete the variable (which you can do, but won’t do often).

### All a... float

In our foobar example, our numbers are both integers. In Python, this means that they are whole numbers. Numbers with a fractional element are a different type called floats. We can check this in Thonny. Click on the Shell and enter:

```
>>> type(foo)
```

The Shell will return:

## Python variable types

Here are the types you can use in Python:

- **Integer (int):** Used to store whole numbers, both positive and negative.
- **Float (float):** Used to store decimal numbers or floating-point values.
- **String (str):** Used to store text or sequences of characters, enclosed in single (‘ ’) or double (“ ”) quotes.
- **Boolean (bool):** Represents a binary value, either True or False, used in logical operations.
- **List:** A mutable, ordered collection that can hold various data types.
- **Tuple:** An immutable, ordered collection that is similar to a list but cannot be modified after creation.
- **Set:** An unordered collection of unique elements, used for mathematical set operations.
- **Dictionary (dict):** Stores key-value pairs, where each key is unique and associated with a value.
- **NoneType (None):** Represents the absence of a value or a null value.
- **Complex (complex):** Used to represent complex numbers with a real and imaginary part.
- **Bytes and bytearray:** Used to represent sequences of bytes, often used with binary data.
- **Custom Classes:** You can define your own custom data types using classes.

We will explore most of these in future tutorials.

### Top Tip

#### Naming matters

Always give meaningful names to variables. It makes your code more readable and maintainable.

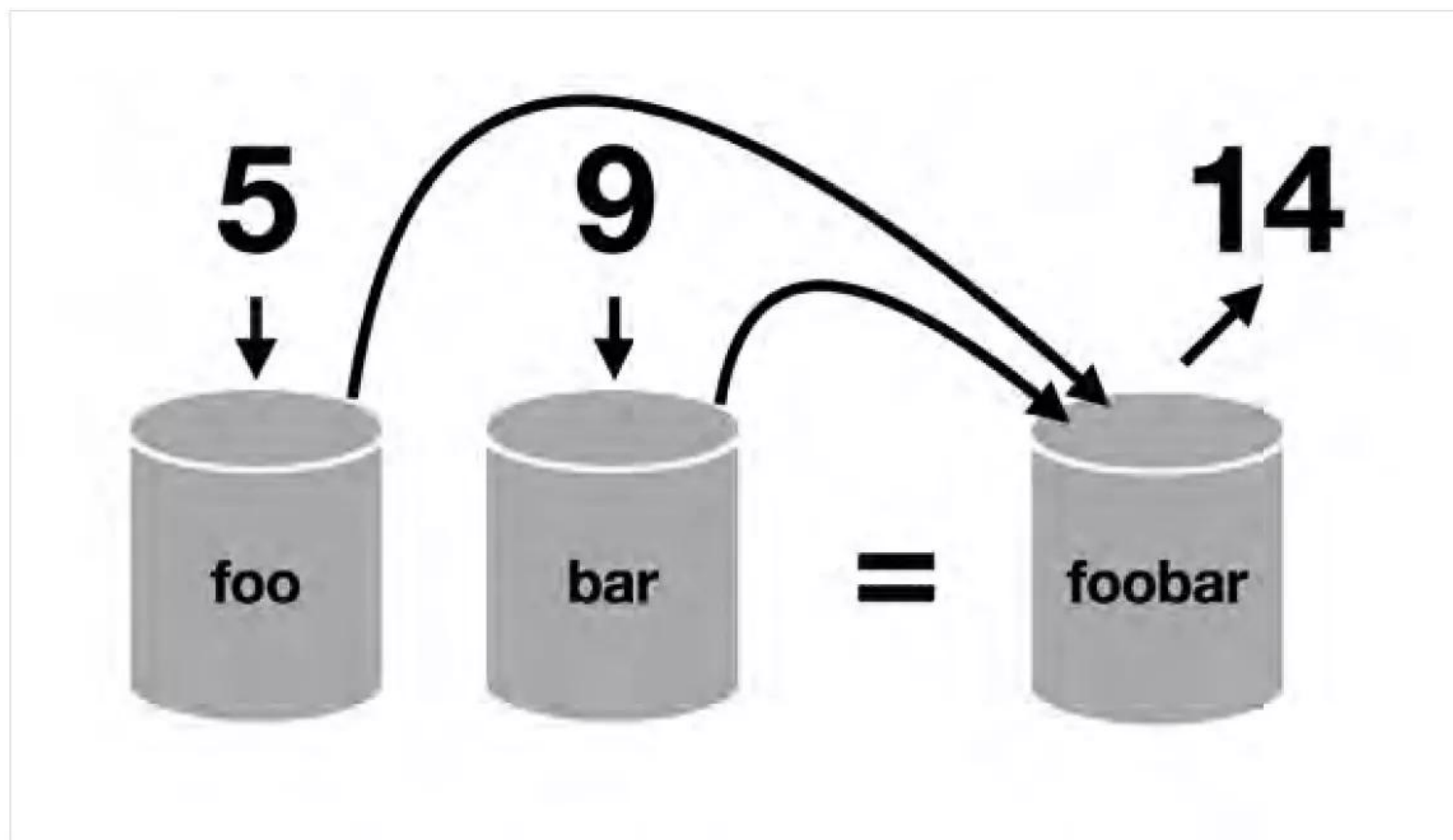

▲ **Figure 2** Variables can be thought of as containers with values that can be inspected and added together (and stored in other containers)

```
<class 'int'>
```

Change the value of `foo` on line 1 to 5.5:

```
foo = 5.5
```

Now run the program and you will see:

```
The variable 'foobar' contains the sum of
'foo': 5.5 and 'bar' 9 which is: 14.5
```

Let's investigate our variables in the Shell. Enter:

```
>>> type(foo)
<class 'float'>
>>> type(bar)
<class 'int'>
```

But what about `foobar`? Because this has been created by adding together a float and an int, it will become a float:

```
>>> type(foobar)
<class 'float'>
```

### Different types, same variable

We've seen how to assign numbers to a variable. We will look at maths in more detail in a future tutorial, but now we're going to look at some of the other things a variable can store.

Alongside numbers, strings (which is another way of saying text) are the things you'll store in Python. You use quotation marks around code to indicate that the value is a string rather than a number.

Python operators work differently on strings. Try this code:

```
foo = "Ben"
bar = "10"
foobar = foo + bar
print(foobar)
```

Click Run and `foobar` will say 'Ben10'. This is because the addition (+) operator concatenates (joins) strings instead of adding them together.

Remove the quotation marks from the `"10"` on line 2 to turn the value into a number so it reads `10`.

Click Run again and you'll get an error message.

```
TypeError: can only concatenate str (not
'int') to str
```

Spot the phrase 'TypeError'. This is Python's way of telling you the error is due to the type of the variables. However, it is possible to work with strings and integers. Try turning the addition (+) operator into a multiplication (\*) symbol:

```
foo = "Ben"
bar = 10
foobar = foo * bar
print(foobar)
```

Click Run and you'll get:

```
BenBenBenBenBenBenBenBenBenBen
```

In this instance, Python multiplies the 'Ben' string 10 times and returns the value.

“ Variables are all-purpose containers you use to store all kinds of things and perform operations on them ”

### True or False

Variables can contain more types than numbers or strings, and the main other type you need to know about (for now) are Boolean values, or 'bools'. These come in two values: True and False.

You can set these values directly in code, i.e.:

```
foo = True
bar = False
```

## Top Tip

Watch your type

It's very easy to reassign values to variables and you can swap between integers, floats, and strings at any time. This can be a problem, as the wrong type can break your code.

But it is more common to use Boolean values to test conditions, such as whether a string matches another piece of information or whether a number is greater than, equal than, or less than another number.

For example, enter the following code (and save it as **greater\_than.py**) to check if the number 10 is greater than the number 5.

```
# Define variables
x = 10
y = 5

# Check if x is greater than y
result = x > y

# Print the result
print(result) # True
```

Variables are all-purpose containers that you use to store all kinds of things, and then perform operations on them and check them against other variables to make decisions about what your program should do.

We will look at these decisions later, but in the meantime enter the code from **fizzbuzz.py**.

FizzBuzz is a famous coding exercise often used in programming interviews or as a beginner's programming task. The goal of the FizzBuzz program is to print a sequence of numbers from 1 to a specified limit (we're going for 100) while following these rules:

1. If the number is divisible by 3, print 'Fizz' instead of the number.
2. If the number is divisible by 5, print 'Buzz' instead of the number.
3. If the number is divisible by both 3 and 5, print 'FizzBuzz' instead of the number.
4. Otherwise, simply print the number.

FizzBuzz makes use of the modulus operator ('%'). This calculates the remainder when one number (the dividend) is divided by another number (the divisor). For example,  $10 \% 2 = 0$ , because  $10/2 = 5$  with no remainder. Whereas  $11 \% 2 = 1$ , because  $11/2 = 5$  with a remainder of 1. You can use this to decide if numbers are even or odd or, in the case of our FizzBuzz program, divisible by threes, fives, or other numbers. It's good practice and we will look at the decisions being made by Python programs in our next tutorial, on 'flow'. 

## foobar.py

DOWNLOAD  
THE FULL CODE:

> Language: Python

 [magpi.cc/python](https://magpi.cc/python)

```
001. foo = 5 # foo is a variable that contains the value 5
002. bar = 9 # bar is a variable that contains the value 9
003. foobar = foo + bar # foobar is a variable that contains
    the sum of foo and bar
004. # print the value of foobar
005. print(f"The variable 'foobar' contains the sum of
    'foo': {foo} and 'bar' {bar} which is: {foobar}")
```

## fizzbuzz.py

> Language: Python

```
001. # This program prints the numbers from 1 to 100, but
    replaces multiples of 3 with "Fizz"
002. # and multiples of 5 with "Buzz".
003.
004. for i in range(1, 101):
005.     # Check if the current number is divisible by both 3
    and 5.
006.     if i % 3 == 0 and i % 5 == 0:
007.         # If so, print "FizzBuzz".
008.         print("FizzBuzz")
009.         # A number that is divisible by both 3 and 5 is
    called a "FizzBuzz" number.
010.
011.     # Otherwise, check if the current number is divisible
    by 3.
012.     elif i % 3 == 0:
013.         # If so, print "Fizz".
014.         print("Fizz")
015.         # A number that is divisible by 3 is called a
    "Fizz" number.
016.
017.     # Otherwise, check if the current number is divisible
    by 5.
018.     elif i % 5 == 0:
019.         # If so, print "Buzz".
020.         print("Buzz")
021.         # A number that is divisible by 5 is called a
    "Buzz" number.
022.
023.     # Otherwise, print the current number.
024.     else:
025.         print(i)
026.         # This is the default case. It prints the number
    if it is not divisible by 3 or 5.
```

# Pico W-powered Bluetooth chord keyboard

Make a chord keyboard that works over Bluetooth



**Rob Miles**

[@robmiles](#)

Rob Miles has been playing with hardware and software since almost before there was hardware and software. You can find out more about his so-called life at [robmiles.com](http://robmiles.com).

**Figure 1** ♦ The key positions have been customised for the author's hands. His left hand is slightly larger than his right

## A

chord keyboard is a great way to enter text on the move. You can type in text without having to look at your fingers. This project builds on the chord keyboard described in Issue 46 of HackSpace magazine, adding Bluetooth connectivity, using a custom PCB, and making it easy to create a keyboard that matches your hand dimensions.

### THE PICO 'BLUE CHORDS' KEYBOARD

**Figure 1** shows left- and right-handed versions of the keyboard. They can be used to enter text, numbers, and symbols. The OLED screen displays the keyboard mode and the last few characters that were entered, along with the Bluetooth connection status. The keyboard is powered by a Raspberry Pi Pico W running C++ code. A rechargeable battery makes the keyboard fully portable. The project uses the KiCad circuit design tool to create the custom-printed circuit board (PCB) and the FreeCAD 3D

modeller to create the case. The positions of the keys and the case layouts are synchronised by Python code running inside KiCad and FreeCAD, allowing for flexible key positioning and ensuring that the holes for the keys match the key positions on the circuit board. You can find the designs, along with the C++ source for the keyboard, on the GitHub repository for this project here: [github.com/CrazyRobMiles/PICO-blue-chords](https://github.com/CrazyRobMiles/PICO-blue-chords).

### TYPING WITH CHORDS

You can see the chords used to enter text using the keyboard in **Figure 2**. The chord system used by this keyboard was first used on devices produced by the Microwriter company in the 1980s. There are six keys: one for each finger and two for the thumb. You enter characters by pressing combinations of keys. **Figure 2** shows the chords for the alphabet. The keyboard understands chords for text, numbers, and a range of symbols. Each of these is selected by putting the keyboard into one of four modes. You select the mode of the keyboard using the 'control' key at the far left. The thumb moves to this key to create chords to change the mode. The mode is displayed at the bottom of the OLED screen. Documentation for the keyboard and charts for all the chord combinations are on the GitHub site for this project. With a bit of practice, you can enter text surprisingly quickly.

### START WITH THE CIRCUIT

**Figure 3** shows the circuit design that was created using KiCad. There are multiple connections for the displays and the keys, so the same board can be used for left-handed and right-handed configurations.



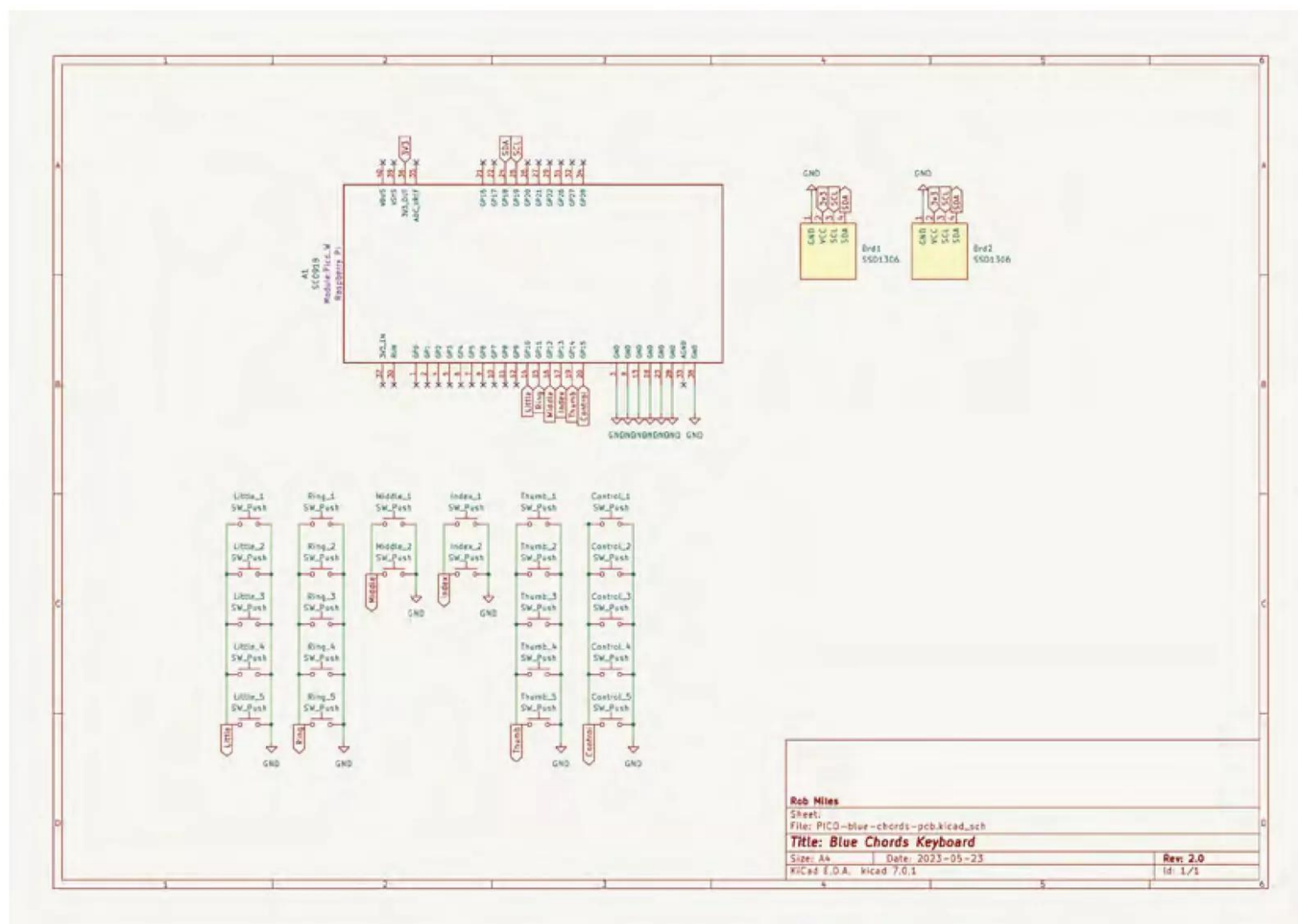

**Figure 3** Only one switch will be placed in each column

The circuit has no connections for power supply and battery management. A LiPo SHIM for Pico from Pimoroni ([pimoroni.com](https://pimoroni.com)) was used for these. Once the design for the circuit was complete, it was time to lay out the PCB.



The same board can be used for left-handed and right-handed configuration



### PCB NUMBER ONE

**Figure 4**, overleaf, shows the PCB design that was sent to be manufactured. This was the first PCB the author had designed from scratch. It turned out to be quite an easy process. You swap between the Schematic Editor (where you design your circuit) and the PCB Editor (where you lay out your PCB) as you refine the design. For the author, the hardest task was finding the right ‘footprint’ designs for each component. The footprints tell the PCB design program what a component looks like on the PCB. For example, the circuit diagram contains a ‘push →

### Text

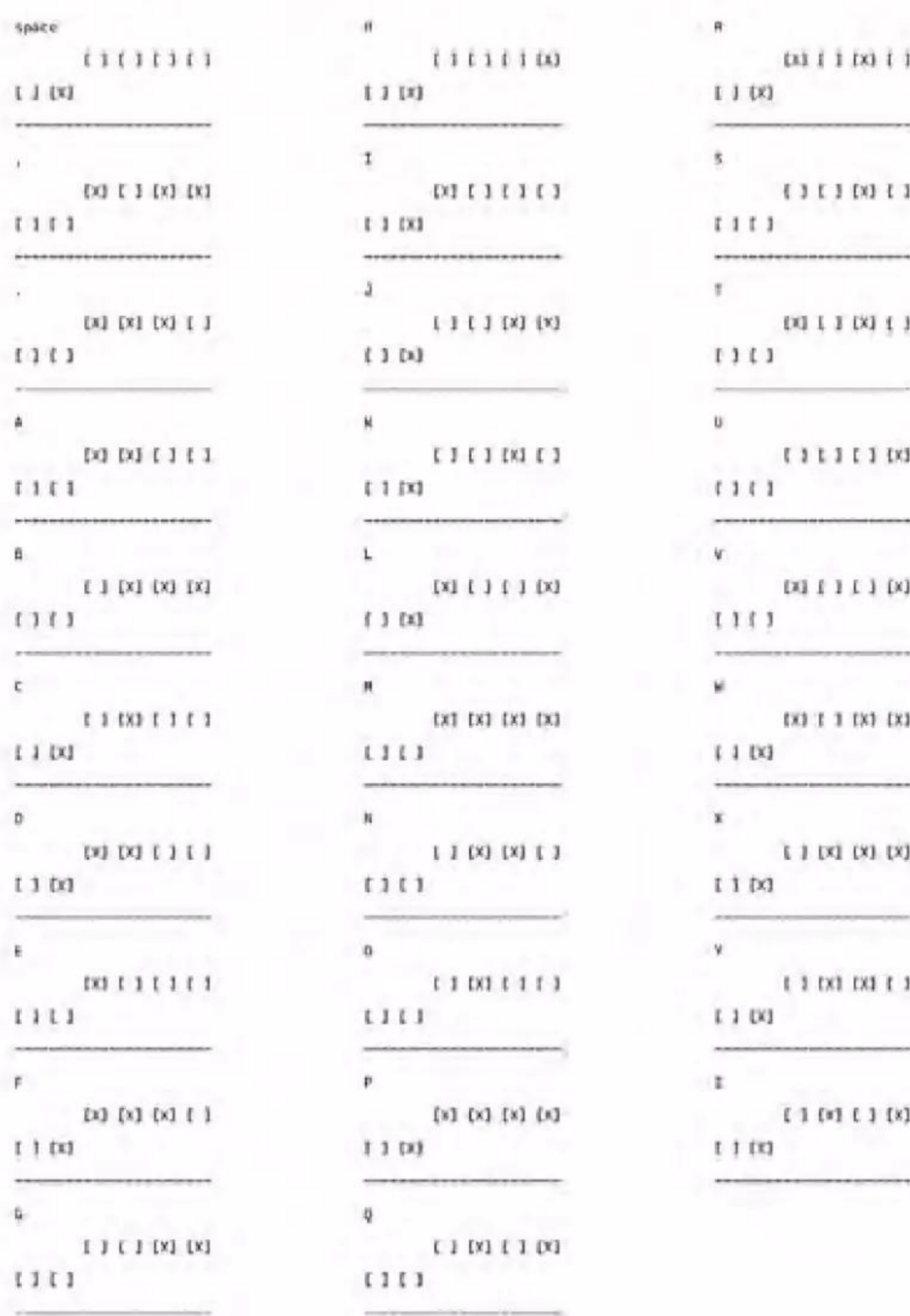

**Figure 2** The chords are shown for right-handed use. They are reversed for left-handed use

### YOU'LL NEED

- PCB**  
 There is a custom-printed circuit board (PCB) design available for this project, although you can connect the circuit by hand if you prefer
- Six key switches**  
 The Kailh mechanical keyboard switches work well
- Six Kailh switch sockets for MX-compatible mechanical keys**  
 These are soldered onto the PCB
- Six keycaps**
- An SSD1306 OLED display**  
 Make sure that you get the monochrome version
- A Raspberry Pi Pico W**
- A micro USB cable to link the Pico W to the host**  
 You will need this for programming and charging
- A battery and power supply**  
 The author used the LiPo SHIM for Pico from Pimoroni along with a Galleon 400mAh hard case LiPo battery
- A case**  
 There is a 3D-printable design, or you can put your keyboard in any box you like

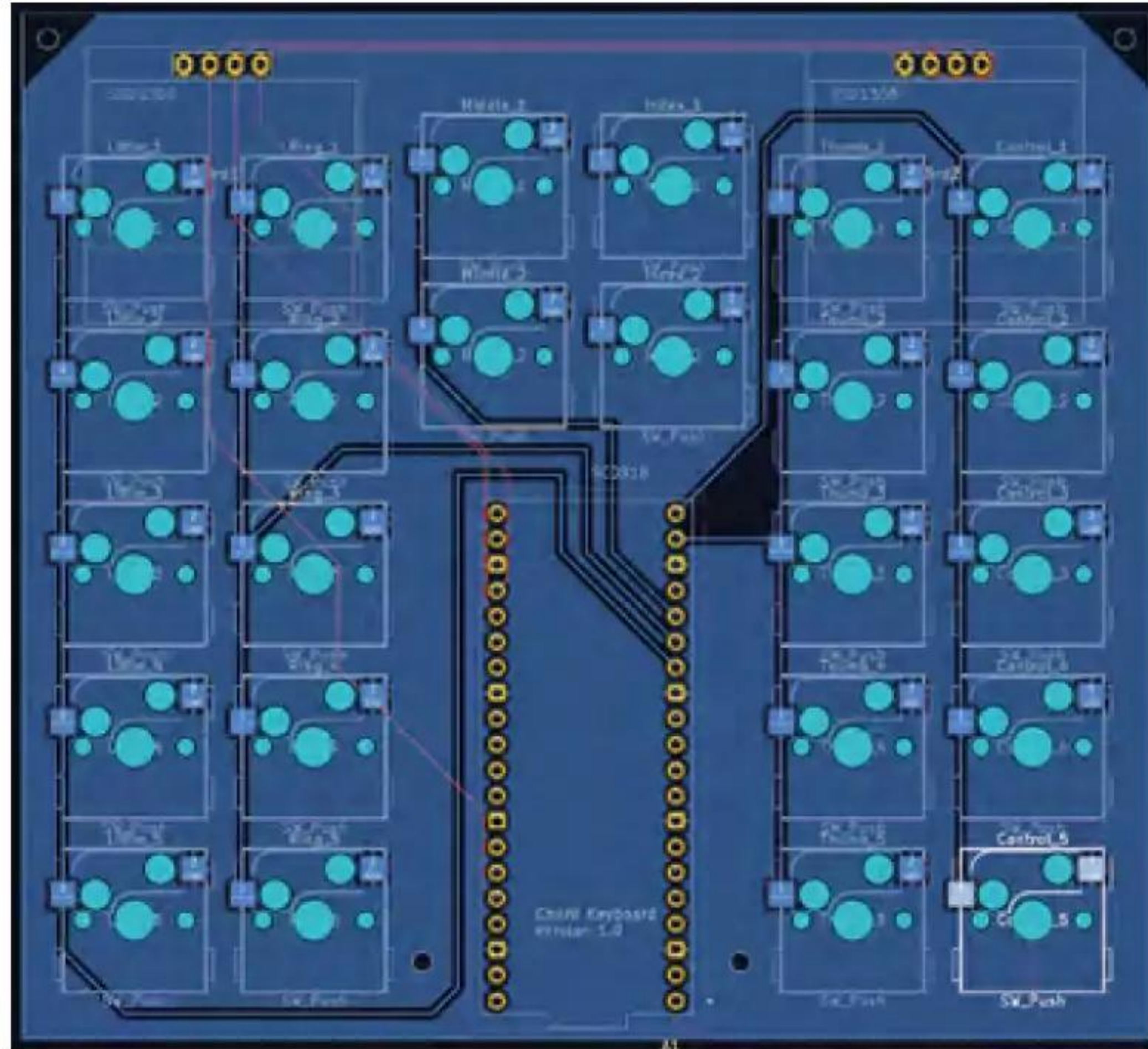

**Figure 4** ♦ Can you spot which column of keys was not connected? The author didn't...

button switch', but the switch footprint required was called 'SW\_Hotswap\_Kailh\_MX'. This is the footprint for a socket into which the keys are fitted. The socket goes on the reverse of the board and the key connects through the board to it. The socket has the characteristic shape you can see above on the diagram, with solder pads for the socket connectors. This footprint file for this design had to be located and added to a library in the project. Then each switch in the circuit diagram was associated with that footprint style. A similar process was followed to get the footprint for the Pico device. There are also 3D designs for most components, so you can use these to make a 3D visualisation of the board. The author was just happy that he managed to get components that looked as if they should work.

### GETTING THE BOARD MADE WAS THE EASIEST PART

The author was expecting all kinds of problems getting the circuit board made, but this was the easiest part of the process. You can add 'plugin' elements to KiCad, and one of the things you can add is a plugin from the PCB manufacturer. In the author's case, this was PCBWay ([pcbway.com](http://pcbway.com)), which had generously offered to sponsor the project. The plugin prepared the project for submission, sent it to the manufacturer, and then opened a web page for the order. The page also showed a visualisation of the board for checking. The process was all very smooth and well-managed – six days after the order was submitted, the finished boards arrived.

**Figure 5** shows a completed keyboard. The switches have been placed for left-handed use. The thumb is used to select between text entry and control functions. The author had hopes of being able to use a chord keyboard with his left hand and the mouse with his right. He was hoping that his brain would transpose chord designs learnt for the

right hand onto the left hand. This was interesting in practice. It turns out that the author's brain can perform this kind of mapping, but it only works if he doesn't think about what he is doing. As soon as he thinks about the keys he needs to press to enter an 'A' with his left hand, he discovers that he is unable to do it. Hopefully this will improve with practice.

### NOTHING IS EVER PERFECT

**Figure 6** shows the rear of the PCB. The production process did a perfect job of converting the designs into a board, but the design was flawed. The extra wires are needed because the author missed off the connection for one column of sockets and wired a display the wrong way round. However, he thinks that it is traditional that the first design of any board should contain mistakes and is proud to be upholding this.

### LIPO SHIM FOR PICO

Given the author's prowess with circuit design, you will be relieved to discover that the PCB he designed doesn't do any of the potentially dangerous power supply management. This is performed by a LiPo SHIM for Pico from Pimoroni, which you can see at the bottom of the PCB in **Figure 6**. The SHIM fits over pins on the Pico and connects to a rechargeable battery. It provides an on-off switch, white power on LED, and red charging LED. It is soldered onto the pins from the Pico which fit through the PCB, enabling a slimline construction. The base of the Pico exposes the micro USB socket, which is used

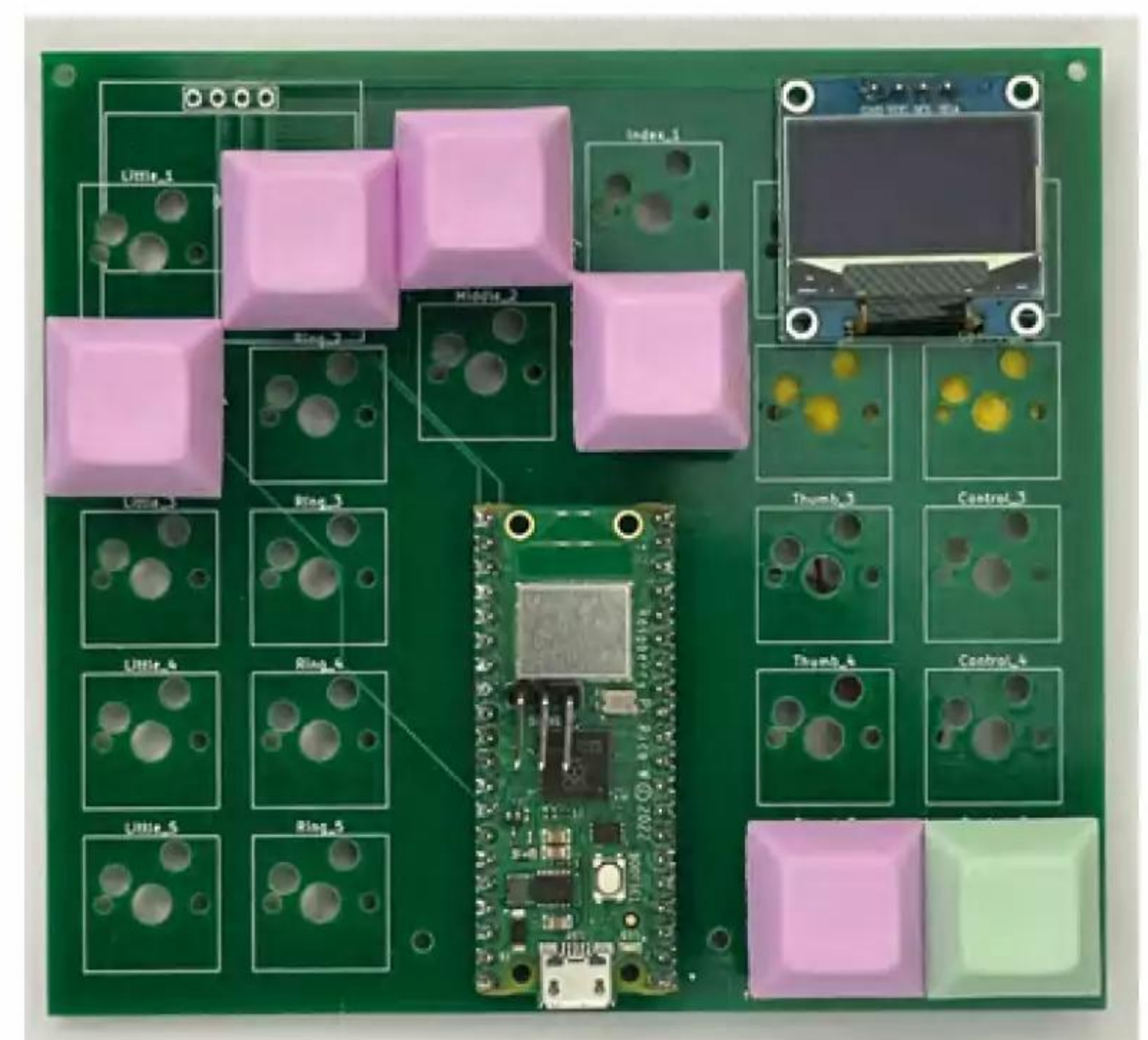

**Figure 5** ♦ The tracks on the top of the board connect the Pico to the display. Tracks on the bottom connect the key switches

### QUICK TIP

Rather than add wires to your circuit diagrams, you can label inputs and outputs and KiCad will connect them. If the author had done this, he wouldn't have got the connections the wrong way round on one of the displays.

for charging. The SHIM exposes the indicator LEDs and power button. The author has found this to be a neat way to create battery-powered Pico projects.

## PANEL BEATING

**Figure 7** shows the front panel of the keyboard. It is a solid piece of printing which has deeply recessed holes for each of the keys. The positions of the keyholes must exactly line up with the sockets in the PCB.

**Figure 8**, overleaf, shows the case being designed in FreeCAD. On the right-hand side, you can see the Python code that is used to create objects that describe the positions of the keys on the PCB.

```
Index_1=["Index_1", 168.60, 52.66, 17.38, 17.38]
```

The statement above shows the object that defines the position of the hole for the first index finger key. The first item in the object is the name of the key, this is followed by the X and Y coordinates and the width and height of the hole. The variable `keyHoles` at the bottom of the code contains a list of the key objects to be used for this keyboard. It also sets the position of the hole for the display.

```
keyHoles = [Little_5, Ring_5, Middle_2, Index_1,
Thumb_1, Control_2]
```

If you want a different set of key holes, you just change the contents of this list. The hole information is extracted from the PCB design by another piece of Python that runs inside FreeCAD and generates these object positions:



**Figure 7** ♦ The keys snap into the holes in the front panel. They are not supported by the PCB underneath. They just plug into it

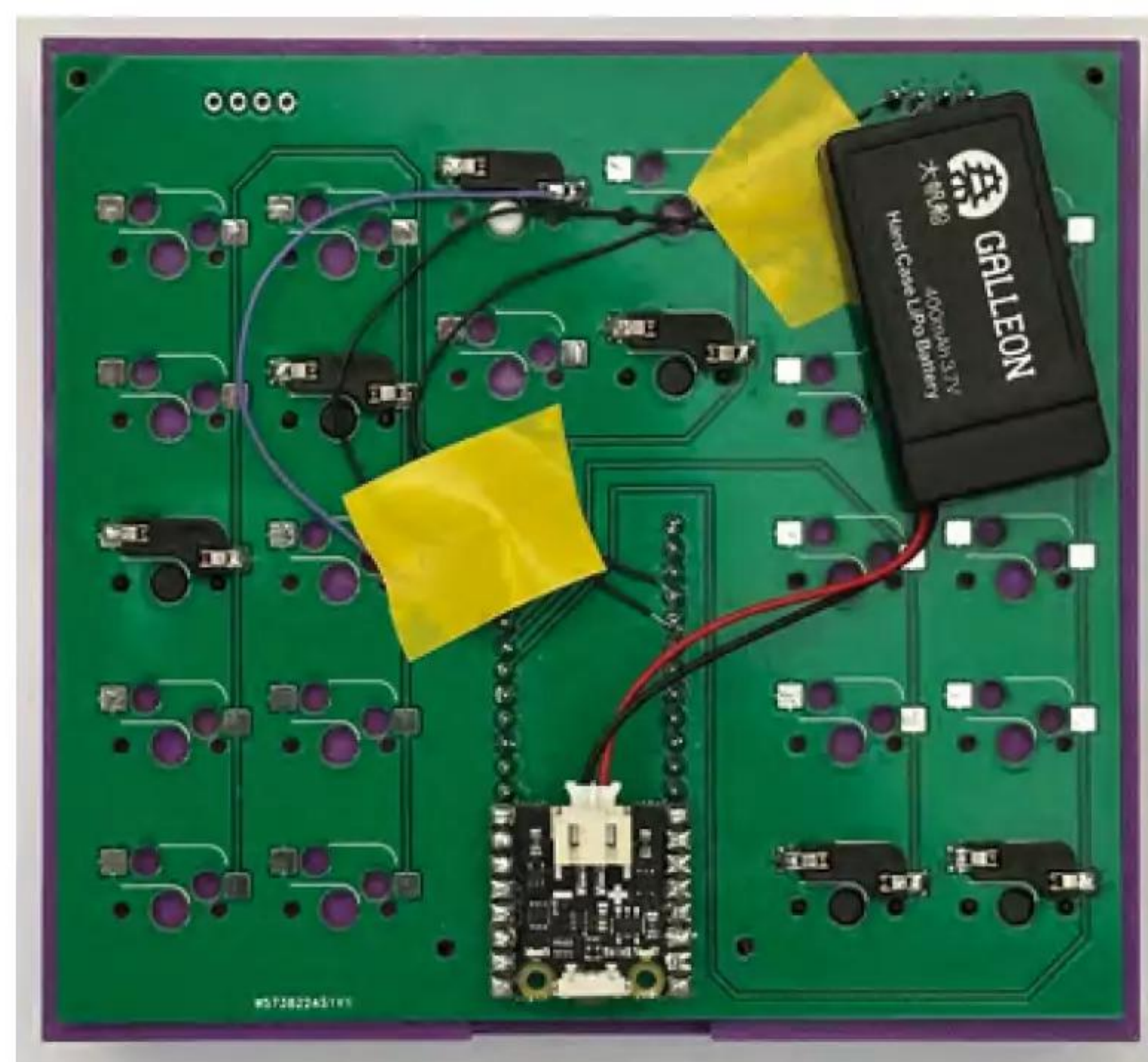

**Figure 6** ♦ If you want to be able to change the key configuration, you can add extra switch sockets for the additional key positions that you want to use

```
import pcbnew

file = "C:\\Users\\rsmil\\Blue Chord\\pcbKeyboard.
KiCad_pcb"

board = pcbnew.LoadBoard(file)

l = []

for f in board.GetFootprints():
    b = f.GetBoundingBox()
    ref = f.GetReference()
    p = f.GetPosition()
    px = (p[0] / 1000000.0)
    py = (p[1] / 1000000.0)
    height = b.GetHeight() / 1000000.0
    width = b.GetWidth() / 1000000.0
    t = '{0} = [{"0}", {1:.2f}, {2:.2f}, {3:.2f}, {3:
.2f}]'.format(ref, px, py, height, width)
    l.append(t)

l.sort()
for t in l:
    print(t)
```

The Python code above runs inside the KiCad PCB Editor and uses the `pcbnew` library to read the footprint positions from the PCB design. It works through the footprints, extracting the name and position of each and assembling an object description. Each of the definitions is added to a list which is then sorted and printed. The program uses the Python `format` feature to print out all the values in millimetres with only two decimal places. This provides the list of component positions you can see in FreeCAD in **Figure 8** and **Figure 9**, overleaf. →

## QUICK TIP

Don't be afraid to add a bit of weight to your prints. The keyboard is all the better for being heavier; it is less inclined to move about when used. The author considers that the extra heft was worth the six-hour printing time.

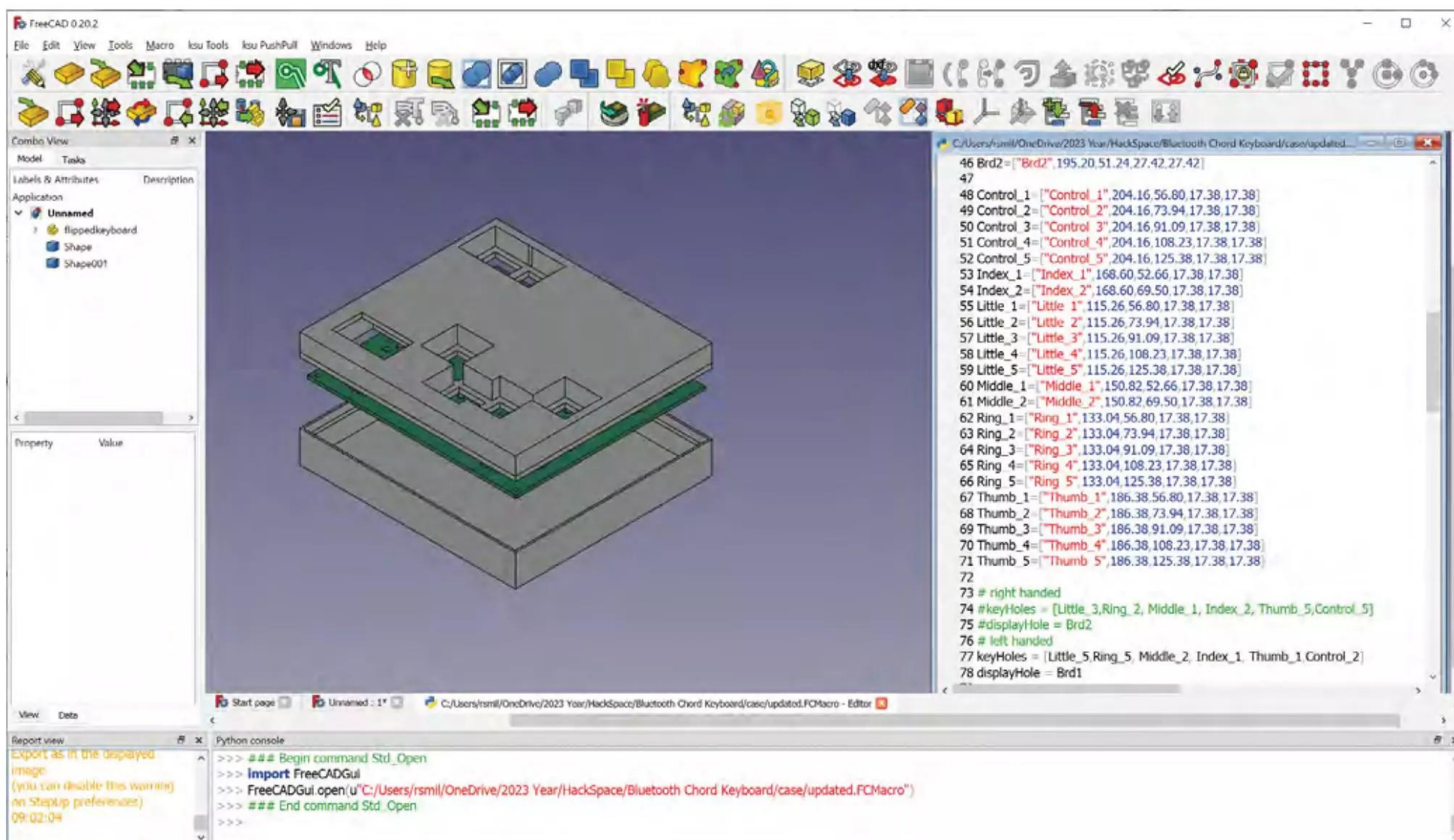

**Figure 8** The kicadStepUp plugin for FreeCAD has been used to import the PCB design so that it can be checked against the case design

**Figure 9** The shell window contains the output from all the print statements in the program

**Figure 9** shows the Python window in KiCad with the output from the program. The amount of footprint data being transferred was very small. If you had a large amount of position information to transfer into FreeCAD, you could write the code into a file to be included in the FreeCAD script. This would allow you to closely integrate the PCB and case creation.

### ONE FUNCTION TO RULE THEM ALL

The keyboard, as designed, works well, but it turns out that the keys are a bit too close together. The

sides of some of the keycaps needed to be filed down a tiny amount so that they moved smoothly. The design needs an increase in the spacing of all the keys by about half a millimetre. At this point, the author has decided that it would be a good idea to use a Python program running in KiCad to position the key footprints as well as generate the position information for FreeCAD. So, the next version of the keyboard will be created using this approach.

### C++-POWERED KEYBOARD

The code that controls the keyboard is based on the Pico W Bluetooth example 'hid\_keyboard\_demo' application from the Pico examples at [github.com/raspberrypi/pico-examples](https://github.com/raspberrypi/pico-examples). This program has a demonstration mode which sends a preset string of text out of the keyboard. It uses a timer to trigger the transmission of each character. The timer has been repurposed to call the `scan_keys` function, as shown below:

```
#define SCAN_INTERVAL_MS 20

static void key_scan_timer_handler(btstack_timer_source_t *ts)
{
    UNUSED(ts);
    // scan the keyboard
    char ch = scan_keys();
    // do we have a key press?
```

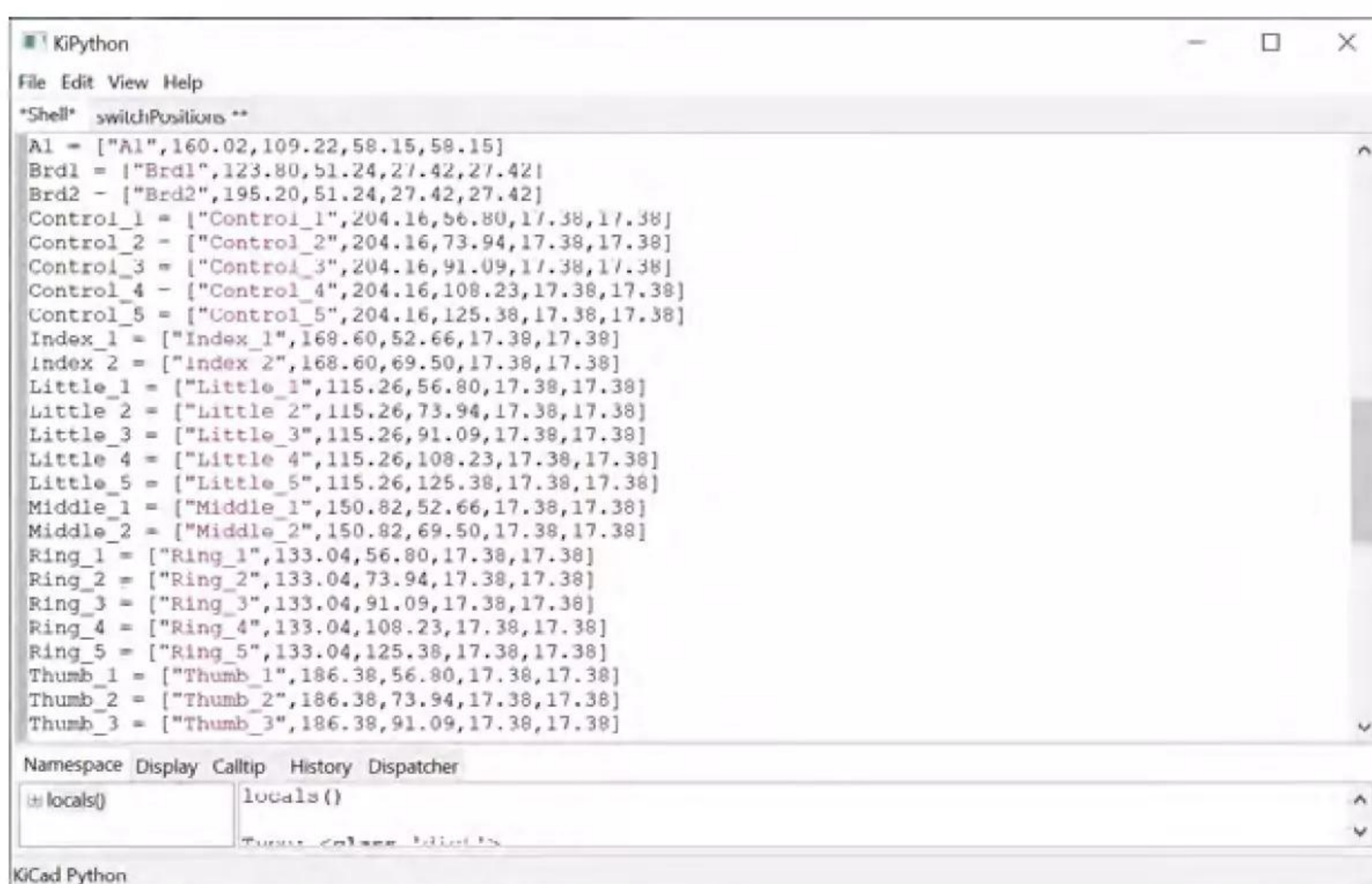



```

if (ch != 0)
{
    // send the key
    stdin_process(ch);
}
// set timer for next character
btstack_run_loop_set_timer_handler(&demo_
text_timer, key_scan_timer_handler);
btstack_run_loop_set_timer(&demo_text_timer,
SCAN_INTERVAL_MS);
btstack_run_loop_add_timer(&demo_text_timer);
}

```

The `key_scan_timer_handler` function is called every 20 milliseconds (50 times a second). It calls the `scan_keys` function and then restarts the timer. The `scan_keys` function performs ‘debounce’ on the input signals. Mechanical switches can produce a rapid sequence of high and low outputs as their contacts open and close. The debounce code ignores these short pulses. A non-zero result from `scan_keys` indicates that a character has been entered. The `stdin_process` function is called to transmit the character. The `stdin_process` function is part of the original demo code, where it is used to transmit characters arriving on the standard input stream. This function also manages Bluetooth pairing, connection, and disconnection. If you want to develop the code further, you can find it all in the project repository. The keyboard also uses a library for the SSD1306 display, which you can find on GitHub here: [github.com/daschr/pico-ssd1306](https://github.com/daschr/pico-ssd1306).

### USING CHATGPT TO CONVERT FROM PYTHON TO C++

This project is based on a previous one written in the Python language. A central component of the Python solution is a set of lookup tables that decode the chord bit patterns from the input switches into character codes. These needed to be converted from Python to C++. The author thought he might use the ChatGPT chatbot ([chat.openai.com](https://chat.openai.com)) to do this. ChatGPT is a language processing tool that has been trained on many millions of articles, including lots about programming. It is adept at taking language input and transforming it. So, a session was opened, and the Python code was pasted in. ChatGPT was then asked to produce a C++ version. This turned

“ It is useful to be able to configure the key positions; it is surprising how different one hand can be from another ”

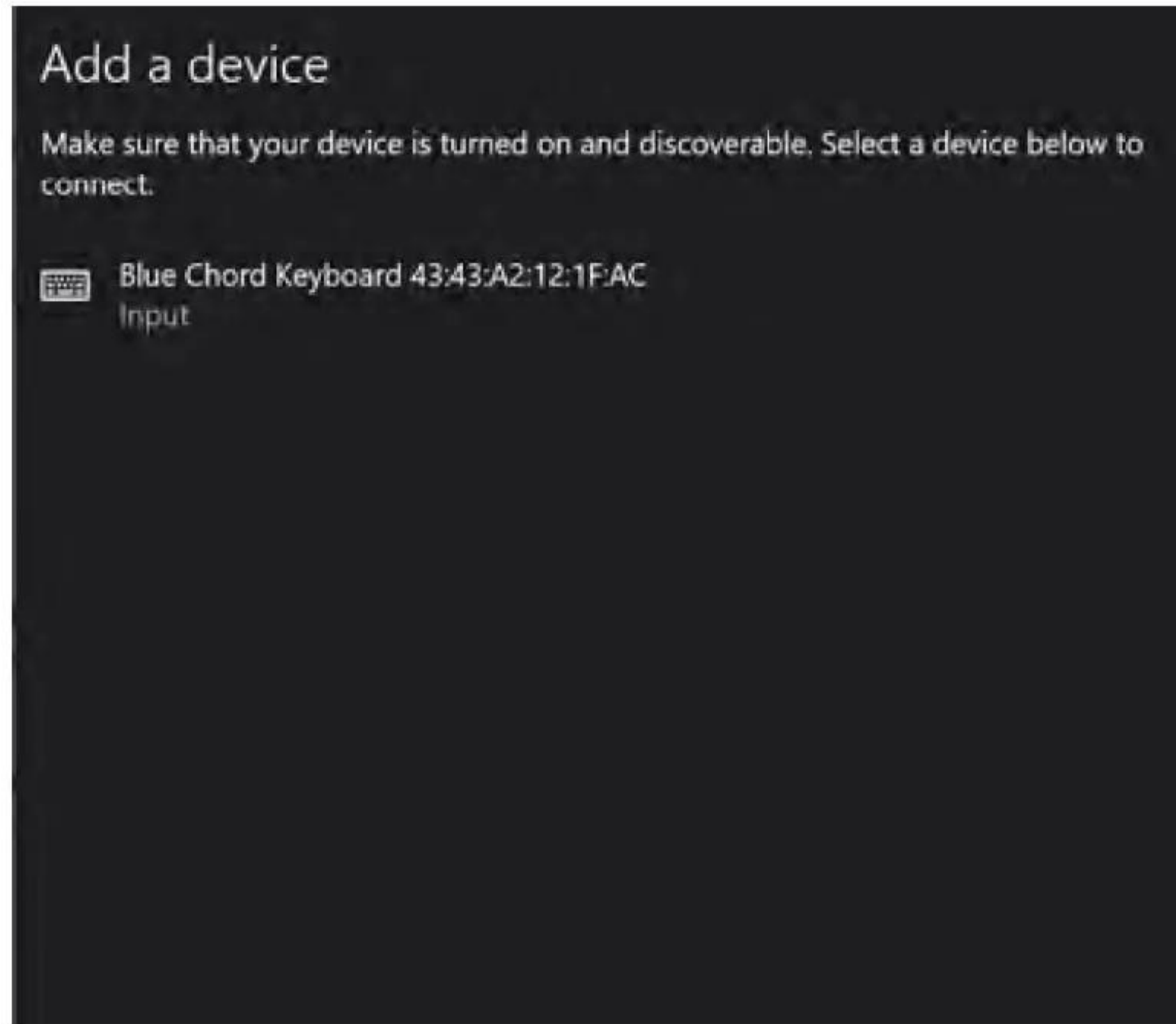

**Figure 10** ♦ The keyboard generates a different Bluetooth address each time it starts

out to be quite successful. ChatGPT can take Python arrays and dictionaries and convert them into equivalent C++ code. However, the code it produces is quite long-winded, so in the end, the author converted the tables by hand using a few edits.

### THE RE-PAIR SHOP

Before the keyboard can be used with a device, it must first be paired with it (Figure 10). Follow the Bluetooth pairing process for the device you

want to use it with.

The screenshot above is from Windows 10.

Once the keyboard has been paired, it will remake a connection if the device disconnects.

However, if you turn the keyboard off and

on again, you may have to re-pair it. This is because the demonstration code the keyboard uses doesn’t retain pairing information inside the Pico. The good news is that battery life is good, so you don’t have to turn the keyboard off very often.

### KEY POINTS

The keyboard was fun to make and works well. It is useful to be able to configure the key positions; it is surprising how different one hand can be from another. The author even found differences in his left and right hands, requiring different keyboard arrangements for each. The integration of Python into the build process means that you can create printable designs for cases which exactly match the PCBs. All the software for the keyboard is in the repository for this project on GitHub, so you can make your own version. There are also code images for left-handed and right-handed versions of the keyboard code that you can just copy into your Pico W if you don’t want to build your own software. The author is looking forward to making more PCBs. □



### HackSpace

This tutorial is from HackSpace magazine. Each issue includes a huge variety of maker projects inside and outside of the sphere of Raspberry Pi, and also has amazing tutorials. Find out more at [hsmag.cc](https://hsmag.cc).



## Electronics housings... as a complete kit.

Available exclusively from our global distribution and wholesale partners you will find the right housing for every application.

With wall, desk & DIN rail mounting options our kits make it easier for you to select the next housing solution for your electronics design.

For additional information call 01952 681700 or visit  
<https://phoe.co/housings-kits-uk>

# Raspberry Pi goes industrial



**Long term availability, high reliability and support**



## Tailor-made embedded solutions

Our range of Raspberry Pi-based devices is wide. Really wide.

But what if your project needs something more? We can put all of our expertise into your custom OEM design.

Visit our website [www.sferalabs.cc](http://www.sferalabs.cc)

# TRICK OR TREAT

WITH RASPBERRY PI

Prepare to frighten or feed your guests this Halloween with these bone-chilling builds and malevolent makes

By beastly bard  
Rob Dreadsloot

**W**elcome, my menagerie of MagPi makers, to this year's haunting and horrifying Halloween dispatch. While, in the past, we've provided you with wicked ways that were *dead certain* to terrify incognito infants and adorned adolescents, we thought they deserved a trickle of treats this year to satisfy their *monstrous appetite*.

We think you'll be *dead pleased* with our spooky selection of petrifying projects, sickly sweets, and abysmal alliterations. Now, *look alive* – time is ticking and you want to be prepared for your ghoulish guests, right?

# ANCIENT ARTEFACTS

Get more icky ideas for your Halloween spookfests with these features of future past



## SMART AND SPOOKY HALLOWEEN PARTY!

Put on your own monster mash with these terrifying tips and tricks for a most spine-chilling shindig.

[magpi.cc/121](http://magpi.cc/121)



## SPOOK UP YOUR RASPBERRY PI

Inspid inspiration for improving ideas idling indoors. And some outside too.

[magpi.cc/110](http://magpi.cc/110)

## HAUNTED HOUSE HACKS

When trick-or-treaters traipse through your turf, make sure they get the dreads they deserve with these mortifying modifications.

[magpi.cc/98](http://magpi.cc/98)



## 10 SPOOKTASTIC HALLOWEEN COSTUME PROJECTS

A collection of chilling costumes for creepy creatives. Scare the *living daylights* out of everyone at the party, or unsuspecting urchins at the door...

[magpi.cc/86](http://magpi.cc/86)





# RASPBERRY PI — TRICKS... —

For foolish fiends that fancy themselves fearless, these terrifying tricks are sure to knock 'em dead



## LED JACK-O'-LANTERN

A good Jack-o'-lantern is essential Halloween décor now – especially now it's the signal that trick-or-treaters are welcome at your house. This creation from GurgleApps ([gurgleapps.com](http://gurgleapps.com)) uses 8x8 LED matrix displays to level up the average candle-filled gourd. It uses a Raspberry Pi Pico to control the LEDs, with fun and/or spooky animations, and runs off batteries for a long while as well. A nice little side effect is that the mouth lights up too.

Make sure you don't keep it out uncovered if it's going to rain, though – those pumpkin lids are not very watertight.

**MODIFICATIONS** You could add a PIR motion sensor so the LEDs light up when someone approaches – that will save battery in the long run and potentially give a scare to your guests!

[magpi.cc/trickledjoi](http://magpi.cc/trickledjoi)

## HAUNTED JACK-IN-THE-BOX

We're not sure where the trend of creepy dolls and/or related children's toys started, but it was probably *The Twilight Zone's* fault. This motion-sensing Jack-in-the-box will automatically wind itself... slowly. With interruptions. Just enough to make you think that something is up. And like the best jump scares, you know it's coming but the tension has built up enough that when it finally pops the weasel, you're likely to jump out of your skin.

A servo controls the lever and a different servo controls when the Jack opens to allow for some mistimed music. The effect is far too good, so make sure you have a change of trousers ready.

**MODIFICATIONS** Add variations to the wind-up, add extra sounds, and even modify the Jack with lights and moving parts for extra scares.

[magpi.cc/trickjack](http://magpi.cc/trickjack)

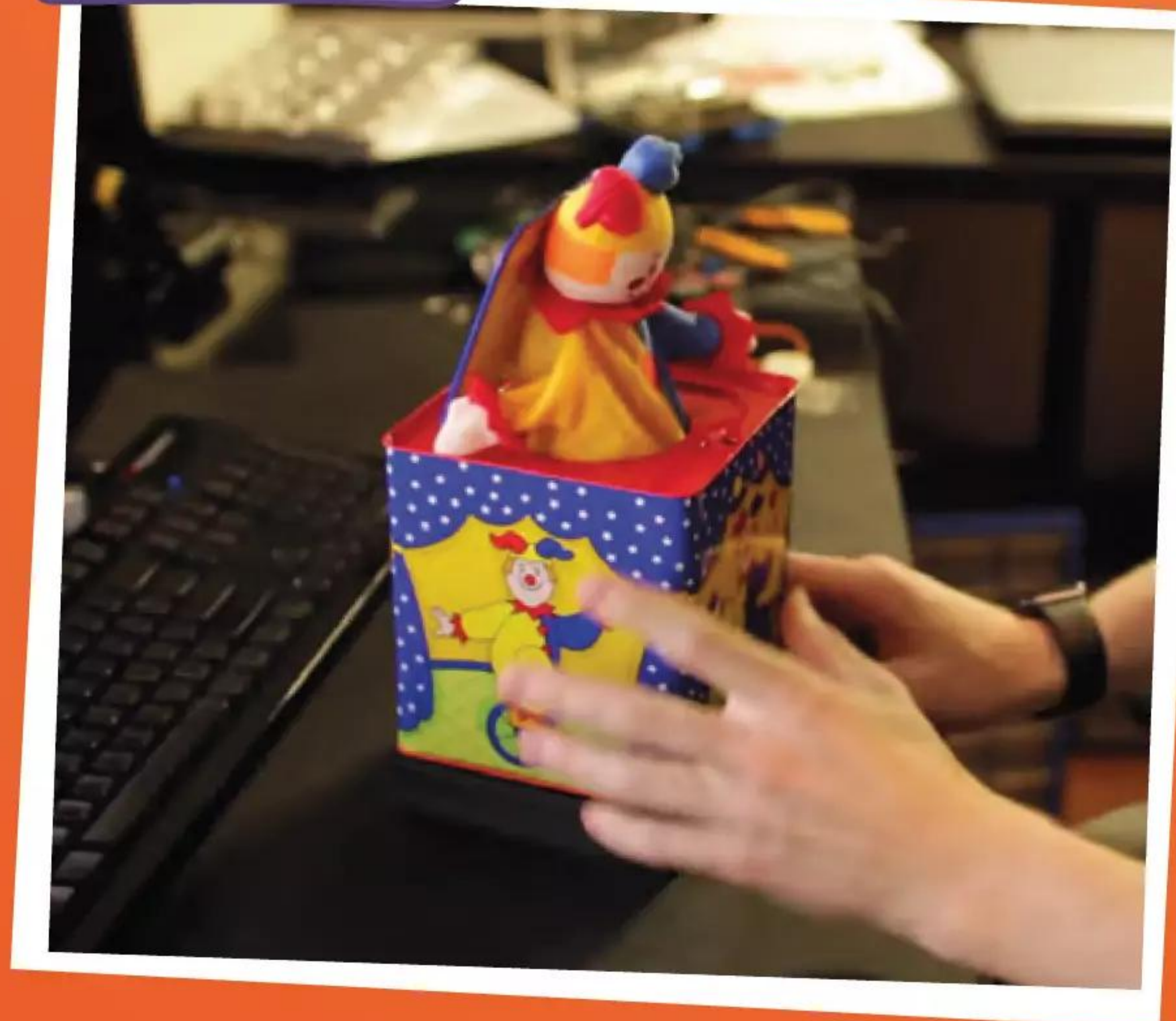

## HAUNTED MIRROR

We've seen Raspberry Pi magic mirrors that have Halloween-themed mods installed for years and years now. However, this version controls not only what you see on the mirror, but also the surrounding lights thanks to Alexa integration.

Maker Ben Eagan connected his Alexa system to the magic mirror's Raspberry Pi and a Philips Hue light. Making use of an Alexa skill and some custom scripts, the mirror blacks out before starting to play a spooky video that looks like a ghost in the mirror. The lights flash to add to the effect. A great little upgrade to a normal magic mirror you might have in your home.

**MODIFICATIONS** Add other effects, or have Alexa activate other connected devices to really spook up the atmosphere.

[magpi.cc/trickmirror](http://magpi.cc/trickmirror)



## TALKING DOORBELL

Every party needs a bouncer, and what better guardian for a Halloween hoedown than a Jack-o'-lantern that talks to those at the door? This RFID-enabled doorbell can allow access to folks with the correct RFID tags in advance, and sends WhatsApp messages to the host whenever someone tries to enter – whether successful or not.

Messages from the doorbell are tailored to whether the guest has an approved RFID tag or not, and whether or not they keep pressing the doorbell, with increasingly threatening messages to those not pre-approved for entry.

**MODIFICATIONS** This project could be updated with a Pico W, use different voice clips depending on RFID codes, and even involve a little scavenger hunt to find hidden keys...

[magpi.cc/trickbell](http://magpi.cc/trickbell)

# CHILLING CINEMA CLASSICS

Our wretched recommendations, approved by the BFI – the British FRIGHT Institute!

### THE THING (1982)

John Carpenter's remake of *The Thing From Another World* (1951) is a special effects masterpiece which was heavily panned when it originally came out. Thankfully, people have come to their senses and this movie, about remote researchers in Antarctica discovering hostile alien shapeshifters and battling their own suspicions, is highly regarded by horror aficionados.

### THE BLAIR WITCH PROJECT (1999)

Popularising the found footage genre of films, this exceptionally creepy movie about a lost student documentary filmed in haunted woods was marketed as being real before release, complete with ARG (alternate reality game) components that had us all asking at the time... wait... is this real?

### ALIEN (1979)

In space, no one can hear you scream, but that won't stop the giant insectoid xenomorph from biting your face off or stabbing you with its tail. This sci-fi horror full of eerie suspense where Sigourney Weaver evades the titular Alien aboard a retro-futuristic spaceship holds up very well.

### THE SHINING (1980)

Stephen King doesn't like it, but this is an iconic horror movie by master Stanley Kubrick, showing Jack Nicholson's slow descent into madness while alone with his family in a giant and very haunted hotel. You may know the entire plot from parodies, though.

### BLADE (1998)

A cult classic comic book movie before the MCU was even a twinkle in Kevin Feige's eye, this is a very fun hack and slashathon involving vampires that keep trying to ice-skate uphill according to Wesley Snipes's inimitable Blade.

# ...OR RASPBERRY PI TREATS!

Treat tiny tricksters with top-notch technology, and they'll be making a killing on the sweet market

## RASPBERRY PI BARTENDER

We've seen a few automatic bartenders, or general drinks dispensers that use Raspberry Pi – in fact, we have a tutorial on how to build one in the previous issue. They all work similarly – pumps are programmed to draw the liquid ingredients from their containers at certain time increments to create a perfectly mixed drink.

This particular one has RFID tags that you use to request specific drinks – and if you want to know how it's being prepared, little icons for each ingredient are shown on the screen as it dispenses them. It does make use of many relays, though, so please be careful if you plan to construct it yourself!

**MODIFICATIONS** Add sound, allow for more manual options, perhaps even have it connect to a smartphone for custom mixes. Drink responsibly.

[magpi.cc/treatbar](http://magpi.cc/treatbar)



## LOVE MACHINE

An unconventional treat idea: give people a compliment! We covered this device in the magazine recently, which works by scanning the provided QR code and results in you being complimented using some lovely auto-generated phrases. It even dispenses sweets at the same time, perfect for Halloween.

It's built from an old toy gumball machine and uses a lot of custom parts to get the stepper motor working to dispense the physical item. Behind the scenes, it uses Raspberry Pi with a web server to allow you to communicate with the machine on WhatsApp. It makes use of Twilio and ChatGPT to write back to you depending on your tone.

**MODIFICATIONS** Add a pumpkin on top to make it fit the Halloween theme, and tweak the responses to be a little more spooky. You could even try and compliment costumes.

[magpi.cc/treatlove](http://magpi.cc/treatlove)



## SCAREDY PI AUTOMATED CANDY DISPENSER

You could give kids candy, but this a technology/ maker magazine, so that's *too* easy. We need to add complicated, perhaps unnecessary electronics to our own custom candy dispenser because it's fun to do. This version takes one of those mini gumball-esque sweet dispensers with a little flap on a hinge. Using a servo and some code, it can easily be opened when activated by, for example, a button. There's more to this system, though – once you get your treats, a loud scream is played and your frightful visage is captured, just like on Space Mountain.

**MODIFICATIONS** You could probably disguise the camera, and maybe install a screen so people can see their image, and/or post it to a social media account.

[magpi.cc/treatscaredy](http://magpi.cc/treatscaredy)



## TRICK OR TRIVIA

Dispensing treats is good and all – that's what we're doing on these pages – but where's the fun in just giving them out? This dispenser has you answer questions to get sweets, but don't worry, they're just multiple choice ones. Worst case, you have a one in four chance of getting some chocolate. There are some similarities to Scaredy Pi, although this build has a 3D-printed 'candy magazine' that pushes candy out the bottom, almost like a Pez dispenser. It's easier to hide it this way in the gravestone that maker Charles Gantt built alongside it.

**MODIFICATIONS** You could add a dispenser for incorrect answers that give out bad jokes, or add casino lighting for correct answers. Also, make sure you have a bowl of sweets anyway. 🍬

[magpi.cc/treattrivia](http://magpi.cc/treattrivia)



## TERRIFIC TREAT TIERS

From supreme sweets to cringe candy, our list is a hazard for dentists



- CHOCOLATE BARS
- FUN-SIZE CHOCOLATE BARS
- BAGS OF SWEETS
- BISCUITS
- SHERBET
- CEREAL BARS
- HARD-BOILED SWEETS
- NUTS
- FRUIT



# Your FREE guide to making a smart TV

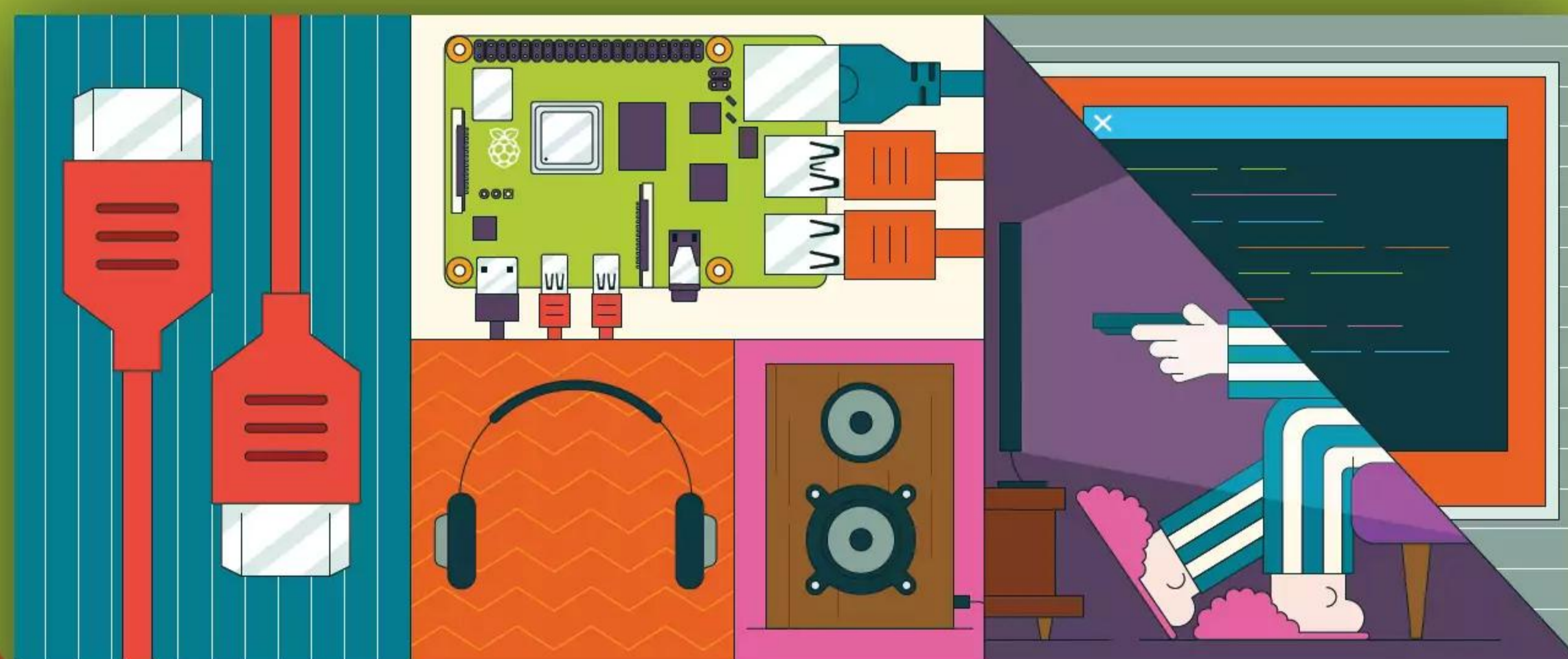

## BUILD A RASPBERRY PI MEDIA PLAYER

Power up your TV and music system

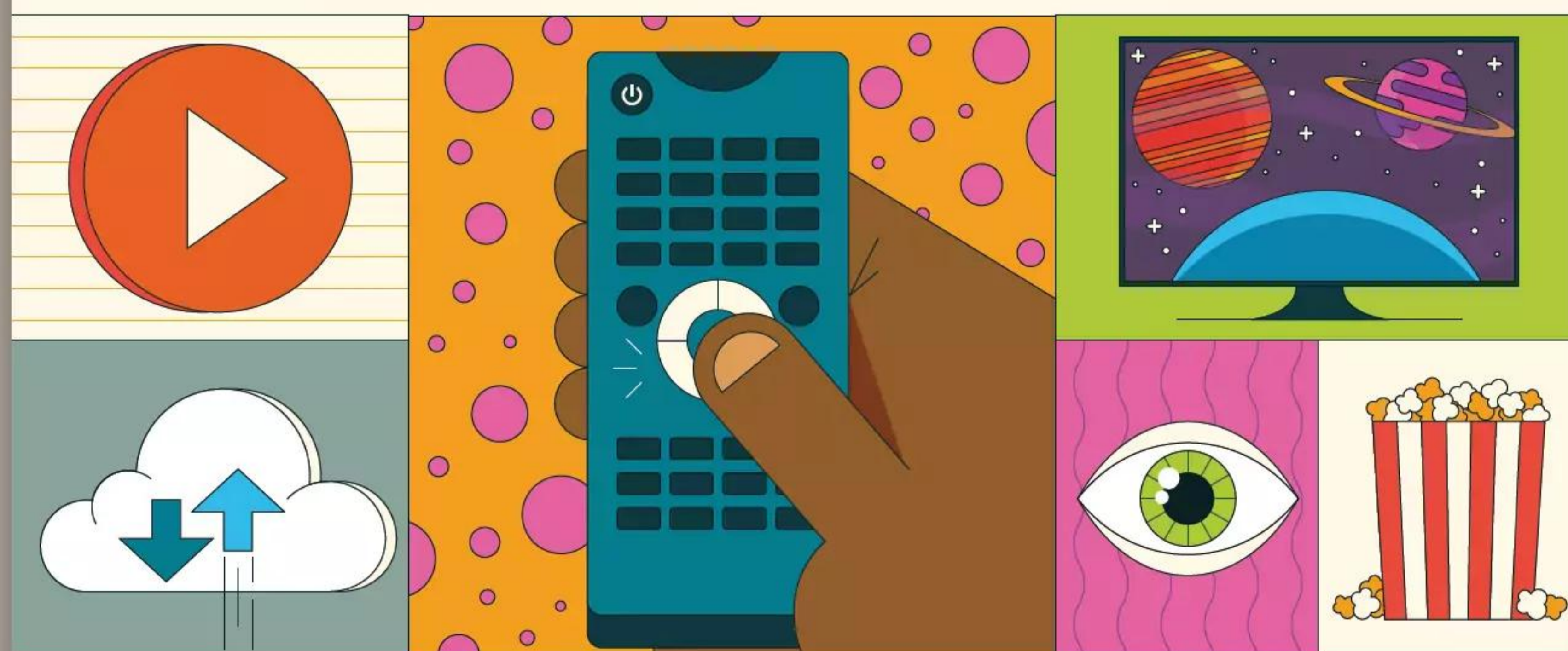

FROM THE MAKERS OF *MagPi* THE OFFICIAL RASPBERRY PI MAGAZINE

[magpi.cc/mediaplayer](http://magpi.cc/mediaplayer)

# CM4 Nano

► EDATEC ► [magpi.cc/cm4nano](https://magpi.cc/cm4nano) ► From £70 / \$90

A ruggedised industrial device based on Compute Module 4.

By **Phil King**

## SPECS

### FEATURES:

CM4 with 8GB, 16GB, or 32GB eMMC storage; 1GB, 2GB, 4GB, or 8GB RAM; optional Wi-Fi/Bluetooth

### PORTS:

2 × USB 3.0, 1 × USB 2.0, 1 × USB-C, Ethernet, GPIO, CSI, DSI, PoE, 5V output

### DIMENSIONS:

95 × 58 × 24 mm

**R**aspberry Pi's compact Compute Module 4 is a popular choice for embedded applications, and is used in numerous commercial devices. The CM4 Nano adds a carrier board with several ports and connectors, protected by a robust metal case with built-in heatsink (the aluminium alloy base).

Accessible via cut-outs, ports include Ethernet, two USB 3.0, one USB 2.0, full-size HDMI, and 40-pin GPIO. An extra USB-C port is found inside when you open the case. Power is via a barrel jack, accepting 7 to 18V DC.

The device is available with optional Wi-Fi and Bluetooth – with an external screw-in antenna to boost the signal – and in several storage and RAM configurations.

## On-board OS

The on-board eMMC storage (from 8GB to 32GB) is pre-installed with standard 32-bit Raspberry Pi OS and a BSP (board support package). It's updatable in the usual ways (including APT), but the OS can be re-flashed if you need a different version (such as 64-bit).

There's also a microSD slot, purely for extra storage, although we found it tricky to insert the card without opening the case – ditto for the CSI (camera) and DSI (touchscreen) connections.

Once powered up, the unit boots up with the usual desktop GUI, although we needed to manually enable Wi-Fi in the taskbar. SSH is enabled by default, but you'll want to change the password for the default 'pi' user for security reasons.

Apart from a slight hum, it all worked similarly to a Raspberry Pi 4. The CM4 Nano's main advantage is that it's more suited to industrial settings, with an improved ambient temperature range of -25 to 60°C. **M**



▲ After removing four screws to open the case, you can view the board and access a hidden USB-C port

“ The on-board eMMC storage is pre-installed with Raspberry Pi OS ”

▼ With a rugged metal case, heatsink base, and external Wi-Fi antenna, CM4 Nano is designed for industrial settings

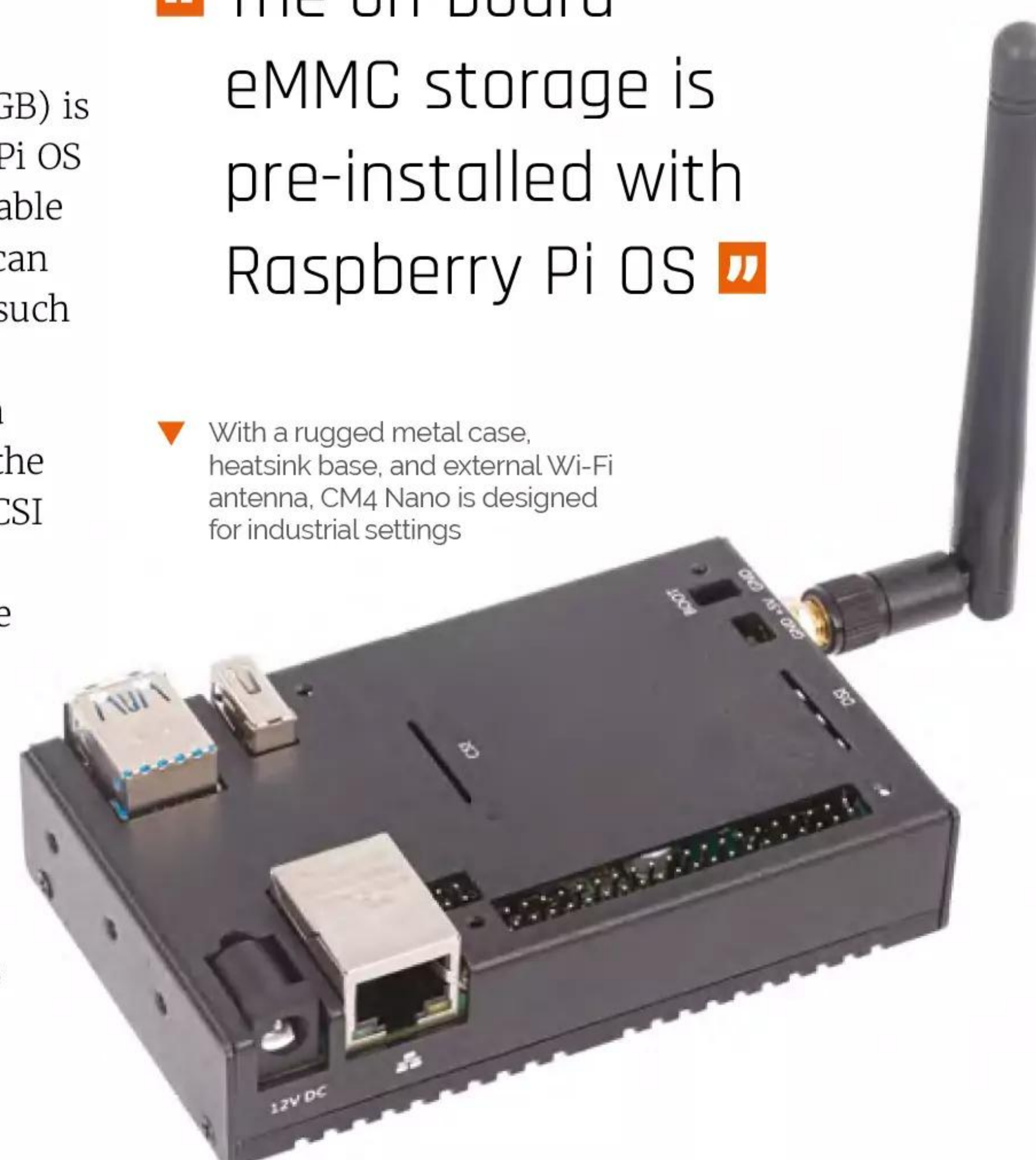

## Verdict

A CM4-based, ruggedised alternative to Raspberry Pi 4 with plenty of configuration options for your exact needs.

**8**/10

# Inventor HAT Mini

► Pimoroni ► [magpi.cc/inventorhatmini](https://magpi.cc/inventorhatmini) ► From £24 / \$25

Mini all-in-one board for robotics and more. By **Phil King**

## SPECS

### INPUTS/OUTPUTS:

4 × GPIO/ADC headers, 4 × servo headers, 2 × JST-SH (6-pin) motor ports, 2 × regular motor outputs, 1 × Qwiic/STEMMA QT port, audio output, external power input, UART header

### FEATURES:

Nuvoton microcontroller, 8 × WS2812B RGB LEDs, User button, DRV8833 dual H-bridge motor driver, motor direction LEDs, pass-through header

### DIMENSIONS:

65 × 30.5 × 15.5 mm

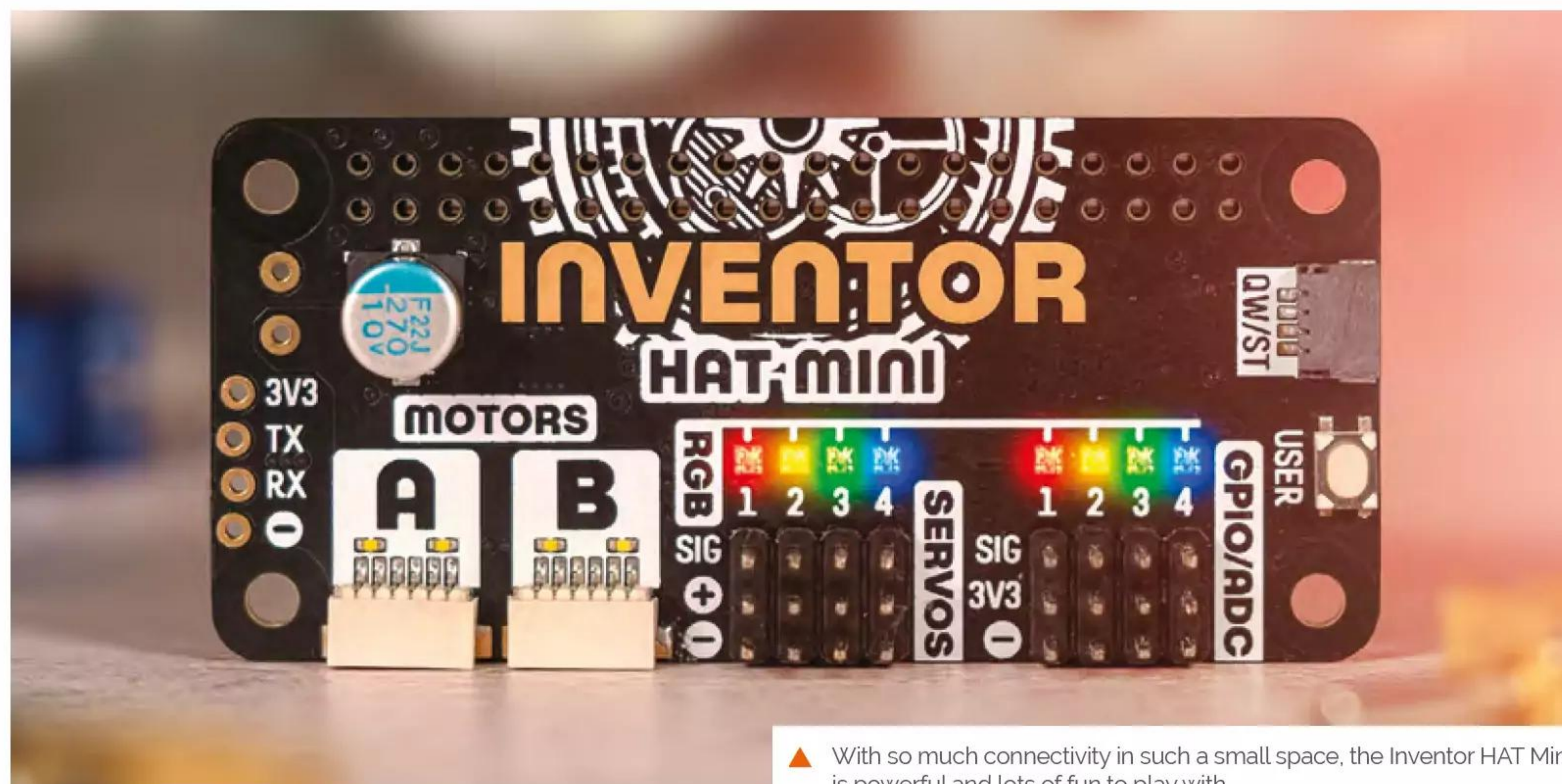

▲ With so much connectivity in such a small space, the Inventor HAT Mini is powerful and lots of fun to play with

**If you are looking for a HAT for all occasions, the Inventor HAT Mini could be it.** This mini add-on board for Raspberry Pi computers is packed with features and could prove useful in a wide variety of projects.

Robotics is an obvious use case thanks to the HAT's two motor ports and four three-pin servo headers. Note that the motor ports are the six-

**“** We can see this board being used with a Raspberry Pi Zero for fun mini robots **”**

pin type used for Pimoroni's encoder-equipped motors, but there's also a header underneath to connect jumper wires to standard motors.

Four extra GPIO channels, each with a three-pin header, are ADC capable, so can be used as

analogue inputs for sensors etc. Best of all, the board's Nuvoton microcontroller handles all I/O, so the board only uses a handful of GPIO pins on Raspberry Pi – and it has a pass-through header so you could stack another board on top by using a stacking header.

### Light and sound

Each set of header pins even has its own RGB NeoPixel, while the motor ports have direction LEDs. There's also a user button and other connections include a single Qwiic/STEMMA QT for breakouts, external power and UART serial headers (both unpopulated), and an audio port (two-pin Picoblade) to connect a mini speaker.

Pimoroni's comprehensive Python library ([magpi.cc/inventorhatminigh](https://magpi.cc/inventorhatminigh)) makes programming the board easy, and a bunch of code examples help you get started. We can see this board being used with a Raspberry Pi Zero for fun mini robots, but it's versatile enough for many other electronics projects. **M**

## Verdict

Packing an impressive array of features into a small footprint, this versatile board is ideal for mini robots and a lot more.

**9**/10



## Astradis Elektronik is Raspberry Pi's distributor for the industry

Discover the extensive possibilities of Raspberry Pi and revolutionise your projects, industrial applications and embedded systems. With its compactness, versatility and compatibility, Raspberry Pi offers a future-proof solution. You get robust computing power and extensive peripheral support, as well as unparalleled hardware and software support through an engaged community worldwide.



With us, you can buy Raspberry Pi's innovative products and rely on reliable and timely deliveries. Our many years of experience in logistics and warehousing enable us to offer you many ways to optimise your production process and thus reduce costs.

### Time to Technology



- In addition to Raspberry Pi products, **we offer** you many suitable components from leading manufacturers, **we optimise** your parts list and combine components into assemblies, which we then manufacture and deliver for you.
- In addition, **we provide** you with development tools for Raspberry Pi products that we have created.

These include, for example, HATs for mobile communication, displays that plug- and-play Raspberry Pi drivers, and development boards with a variety of interfaces to exploit the full potential of Raspberry Pi.



**ATXX 5G Shield HAT**

### Time to Market



- To successfully bring your product to market, **we help you optimise the design and find the best solution for distribution.**
- **We offer flexible external storage solutions** from micro SD cards to integrated SSD hard drives.
- Together with our partners, **we can securely flash your software and meet your security requirements.**
- **We are happy to organise production for you and deliver a finished ODM product with the „Powered by Raspberry Pi“ label.**

**Do you have an idea for partnership? Please contact us @ [a.feix@atxx.de](mailto:a.feix@atxx.de); Phone: +49 89 89 505-231**

# 10 Amazing: Starter kits

Get started on your first Raspberry Pi build

**W**e still get people asking us what they can do with Raspberry Pi. It's far easier to answer that these days than it was in 2012 thanks to gigantic support from the worldwide community creating kits and inspiring projects. Here are ten ways to get started with your Raspberry Pi... 



## ▲ CamJam EduKit #3 - Robotics

### Robots for newbies

Our go-to robot starter kit recommendation, the CamJam kit 3 has all the basics you need to get a robot built. You just need to supply your own Raspberry Pi.

[magpi.cc/camjamedu3](http://magpi.cc/camjamedu3) | £20 / \$25



## ▲ Raspberry Pi 4 Desktop Kit

### Plug and play

Everything you need to get started with a Raspberry Pi 4 – including a Raspberry Pi 4, case, accessories and a complete Beginner's Guide.

[magpi.cc/pi4desktopkit](http://magpi.cc/pi4desktopkit) | £123 / \$153



## ◀ Pi-hole Raspberry Pi 4 kit

### Ban dangerous ads

Pi-hole is a great software project that allows you to block ads from entering the network, keeping your personal devices safe from malicious code. It's also an interesting way to learn the ins and outs of networking.

[magpi.cc/piholekit](http://magpi.cc/piholekit) | £82 / \$102

## ► Raspberry Pi Zero 2W Starter Kit

### Small but mighty

Raspberry Pi Zero 2 is very powerful, but you still need some adapters to get the most out of it. This kit includes a Zero 2 and all the basic accessories you might need for it.

[magpi.cc/zero2sk](http://magpi.cc/zero2sk) | £51 / \$67





## ▲ Raspberry Pi 400 Personal Computer Kit

### All-in-one

A full Raspberry Pi computer built into a keyboard, much like the home computers of yore. That makes it very portable – all you need is a spare monitor.

[magpi.cc/raspberrypi400](https://magpi.cc/raspberrypi400) | £114 / \$142

## ▶ Starter Kit for Raspberry Pi Pico

### Electronics box

Pico is a great microcontroller for powering all your electronic and IoT projects – this kit comes with a Pico with a GPIO header attached, and loads of components to learn to code with.



[magpi.cc/picoeleckit](https://magpi.cc/picoeleckit) | £10 / \$12

## ▶ Grove Base Kit

### Home automation

Fancy automating your home? Grove is a great system for experimenting with IoT, and lets you learn how it works before being easily upgradeable to full home control.



[magpi.cc/grovebasekit](https://magpi.cc/grovebasekit) | £39 / \$49



## ▲ Raspberry Pi Pico Advanced Kit

### 32-in-1

This kit holds a huge number of different components, making it an amazing starter kit for someone who wants to learn everything about microcontrollers, robots, and coding.

[magpi.cc/advpicokit](https://magpi.cc/advpicokit) | £37 / \$46

## ▶ Electronics Kit for Pico

### More with Pico

Already got a Pico? Then this kit is a good way to learn a lot of circuitry thanks to a mixture of LEDs, resistors, and a motor.

[magpi.cc/picolite](https://magpi.cc/picolite)  
£16 / \$20



## ▶ CrowPi L

### Laptop kit

Part of the CrowPi family of Raspberry Pi laptops, using your own Raspberry Pi inside an advanced shell to create the ultimate portable Raspberry Pi.



[magpi.cc/crowpil](https://magpi.cc/crowpil) | £176 / \$219

# RETRO GAMING

WITH

# RASPBERRY PI

2<sup>ND</sup> EDITION

***Retro Gaming with Raspberry Pi*** shows you how to set up a Raspberry Pi to play classic games. Build your own games console or full-size arcade cabinet, install emulation software and download classic arcade games with our step-by-step guides. Want to make games? Learn how to code your own with Python and Pygame Zero.

- *Set up Raspberry Pi for retro gaming*
- *Emulate classic computers and consoles*
- *Learn to code your own retro-style games*
- *Build a console, handheld, and full-size arcade machine*

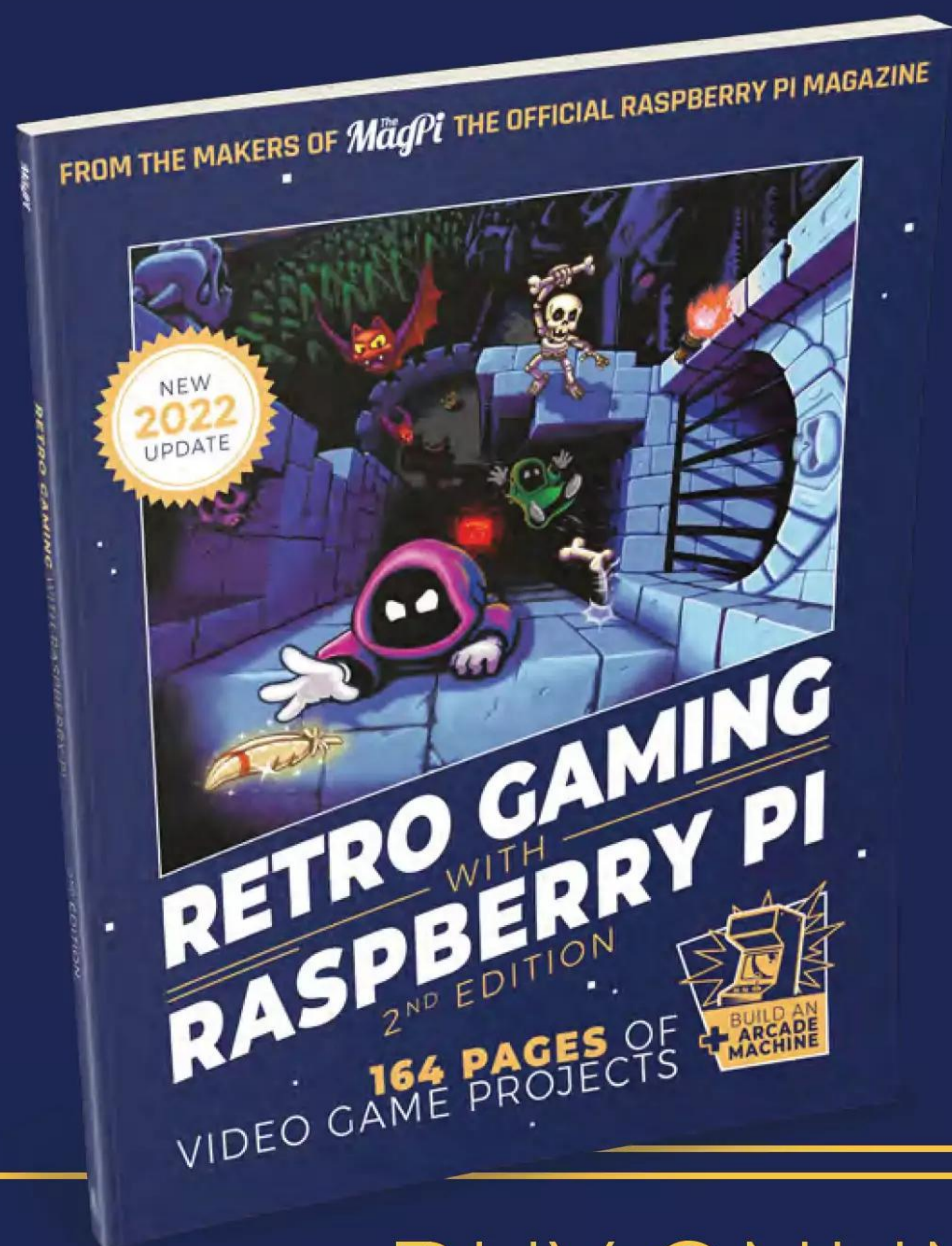

BUY ONLINE:  
[magpi.cc/store](https://magpi.cc/store)



# Learn robotics with Raspberry Pi

Start building Raspberry Pi robots with the help of these resources.

By **Phil King**

## Kev's Robots

AUTHOR

**Kev McAleer**

Price:  
Free

[kevsrobots.com](http://kevsrobots.com)

Long-time robot builder Kevin McAleer shares his regular projects – he aims to make a new robot every month – and a whole lot of expert knowledge on this fun-packed site. His enthusiasm is infectious.

Many of Kev's robots are based on a Raspberry Pi computer, Pico microcontroller, or RP2040-based board. Each project includes full step-by-step instructions, including videos (from his YouTube channel – [magpi.cc/kevmcaleeryt](http://magpi.cc/kevmcaleeryt)), a bill of materials, files for any

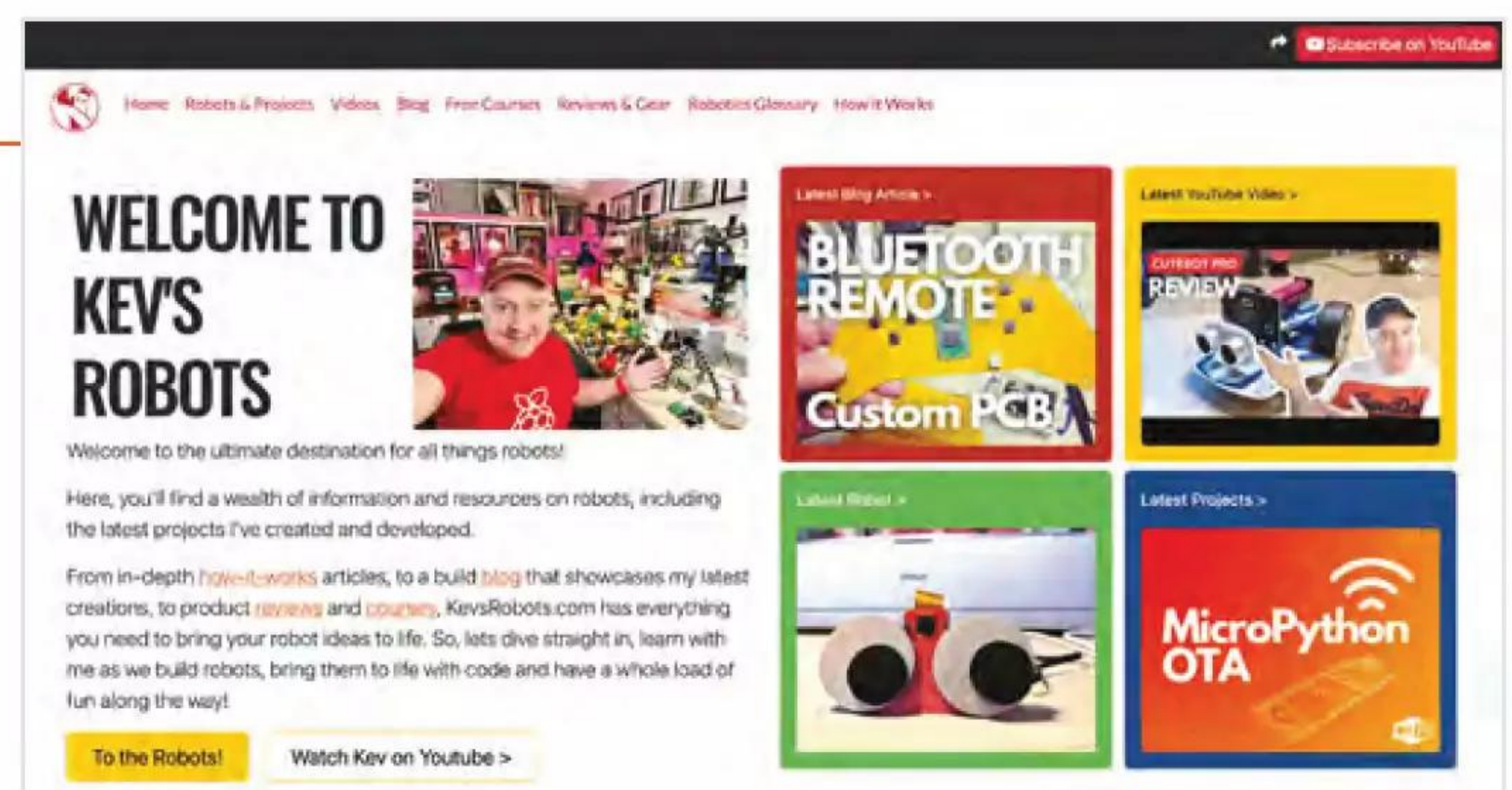

3D-printed parts, and code listings. So, you have everything you need to get building one.

Even better, Kev has created a Learn Robotics course pathway comprising five modules, starting with a 'Robotics 101' introduction to the concept. This is followed by modules

on learning Python and MicroPython, before moving on to mastering the GPIO pins and using Fusion 360 to design a robot eye mechanism. In addition, there's a very useful course on learning the popular ROS (Robot Operating System). **M**

## Get kitted out

Start learning with these robot kits

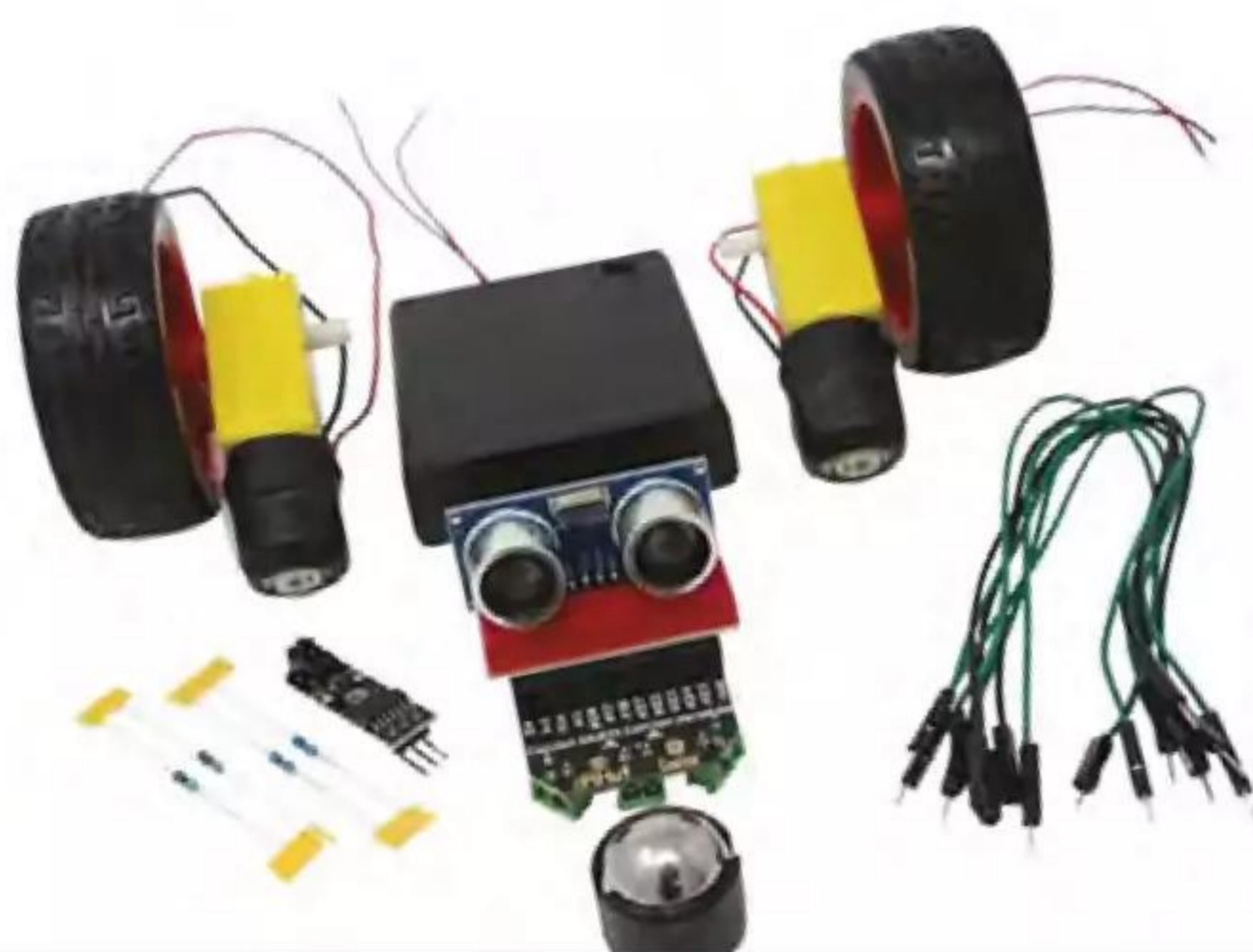

### CAMJAM EDUKIT #3

An ideal beginner's kit, it includes everything you need to build your first wheeled robot – you can use the box as a chassis! The online lesson plan is a great help.

► [magpi.cc/edukit3](http://magpi.cc/edukit3)

### MEARM MAKER KIT

With laser-cut acrylic parts, this robotic arm is fairly inexpensive (£47) and easy to assemble. Four servos

give it a good range of movement, enabling it to pick up objects. Just add a Raspberry Pi.

► [magpi.cc/mearmmaker](http://magpi.cc/mearmmaker)

### TRILOBOT

This slick-wheeled robot kit houses Raspberry Pi in a sandwich of PCB boards with plenty of ports/headers for expansion options. It even has cool RGB underlighting!

► [magpi.cc/trilobot](http://magpi.cc/trilobot)

# Build a Robot Buggy

AUTHOR

Raspberry Pi Foundation

Price: Free

[magpi.cc/buildbuggy](https://magpi.cc/buildbuggy)

At the time of writing, the Raspberry Pi Foundation's full 'Learn Robotics' educational course is temporarily unavailable (hopefully due to appear on edX soon), but you can build the same robot buggy by visiting the Foundation's projects site.

If you're a newcomer looking to get started by building a Raspberry Pi-based wheeled robot, this is an ideal project tutorial to follow. You'll learn how to set up a standard L298N motor controller board with two small 6V DC motors and control them using Python code. Finally, you can add a makeshift chassis, comprising a plastic or cardboard box, and power your robot with a battery pack.

Every step is covered in meticulous detail, and is illustrated with photos. The Python code is made simpler with the use of the GPIO Zero library. 

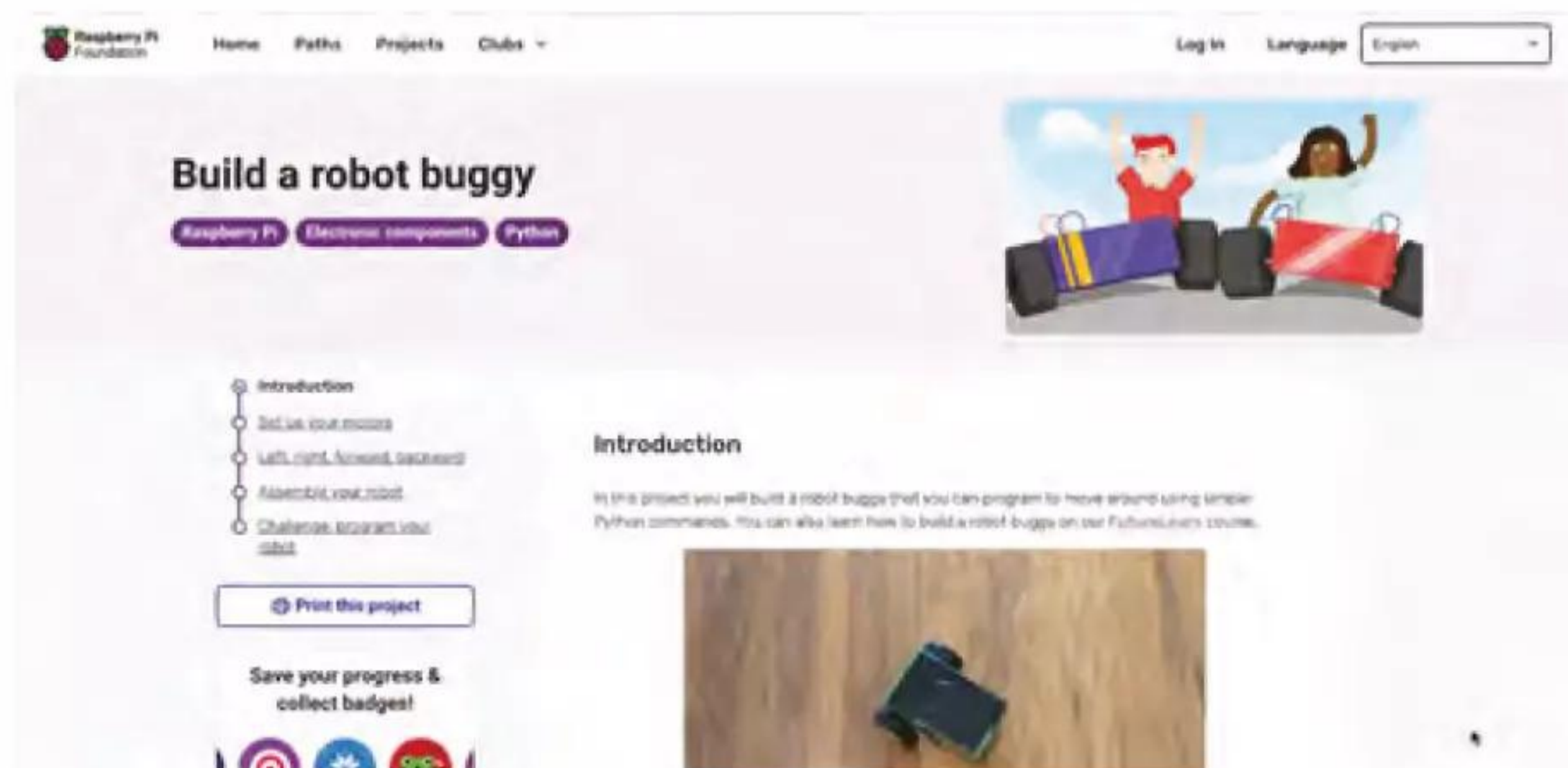

# Robotic Arms & Legs

AUTHOR

The MagPi

Price: £5.99 / Free (PDF)

[magpi.cc/131](https://magpi.cc/131)

Building and programming a wheeled robot is great fun, but there's a lot more to robotics than that. Another branch is 'articulated robotics': building robotic arms and legs with multiple joints

controlled by servo motors for precision movement.

To learn more about this topic, check out Danny Staple's 'Python Robots' feature in *The MagPi* issue 131. It explains aspects such as different types of servo you can use, and covers some of the most popular kits.

One of the latter, the inexpensive MeArm Maker Kit, is used in a step-by-step tutorial on how to control a robot arm with MicroPython code running on a Raspberry Pi Pico W from a web interface. PWM (pulse-width modulation) is used to adjust the precise position of each servo. The techniques learned can be applied in other articulated robotics projects. 

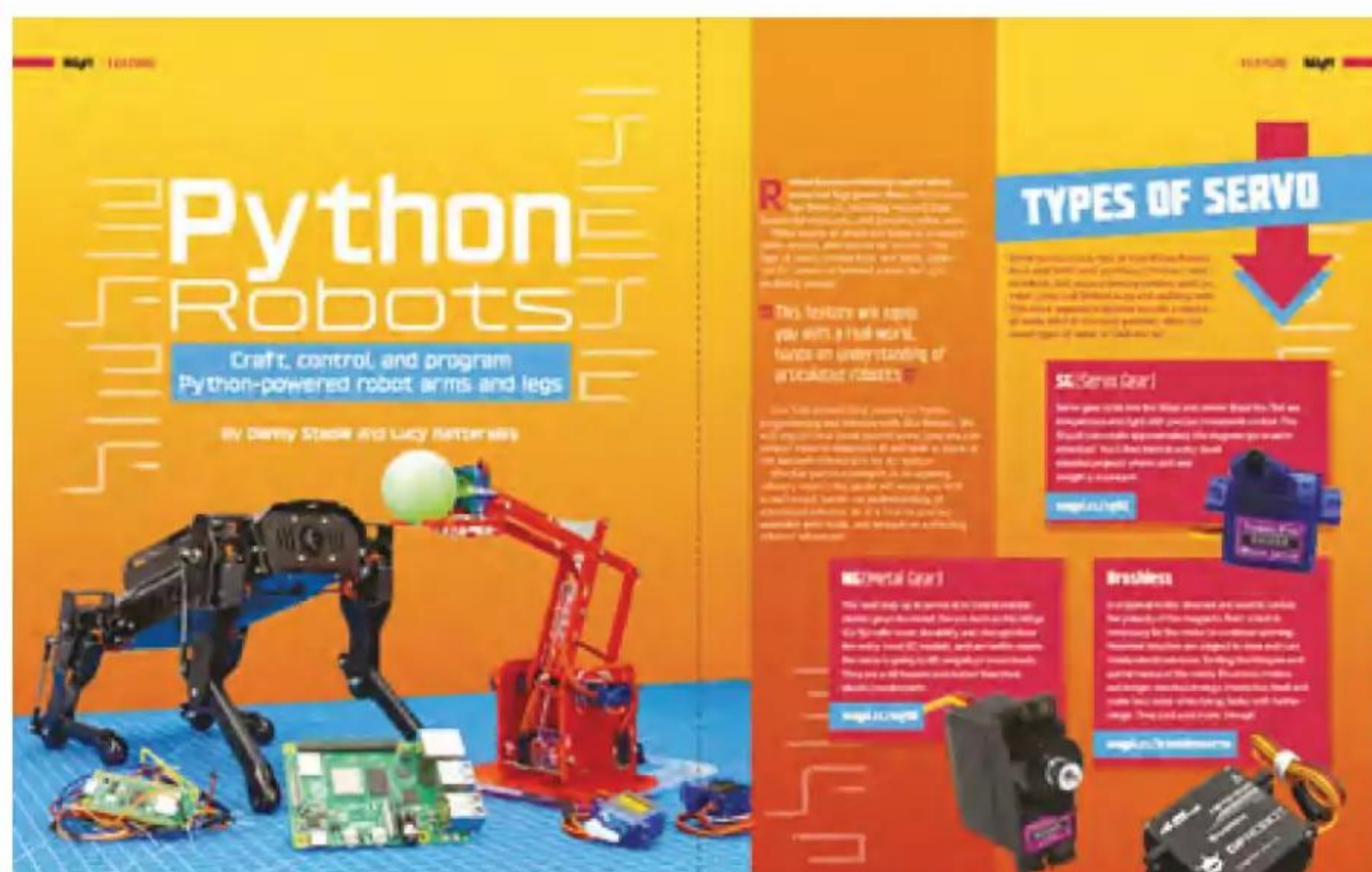

## Recommended reading

Books to help you get to grips with robotics

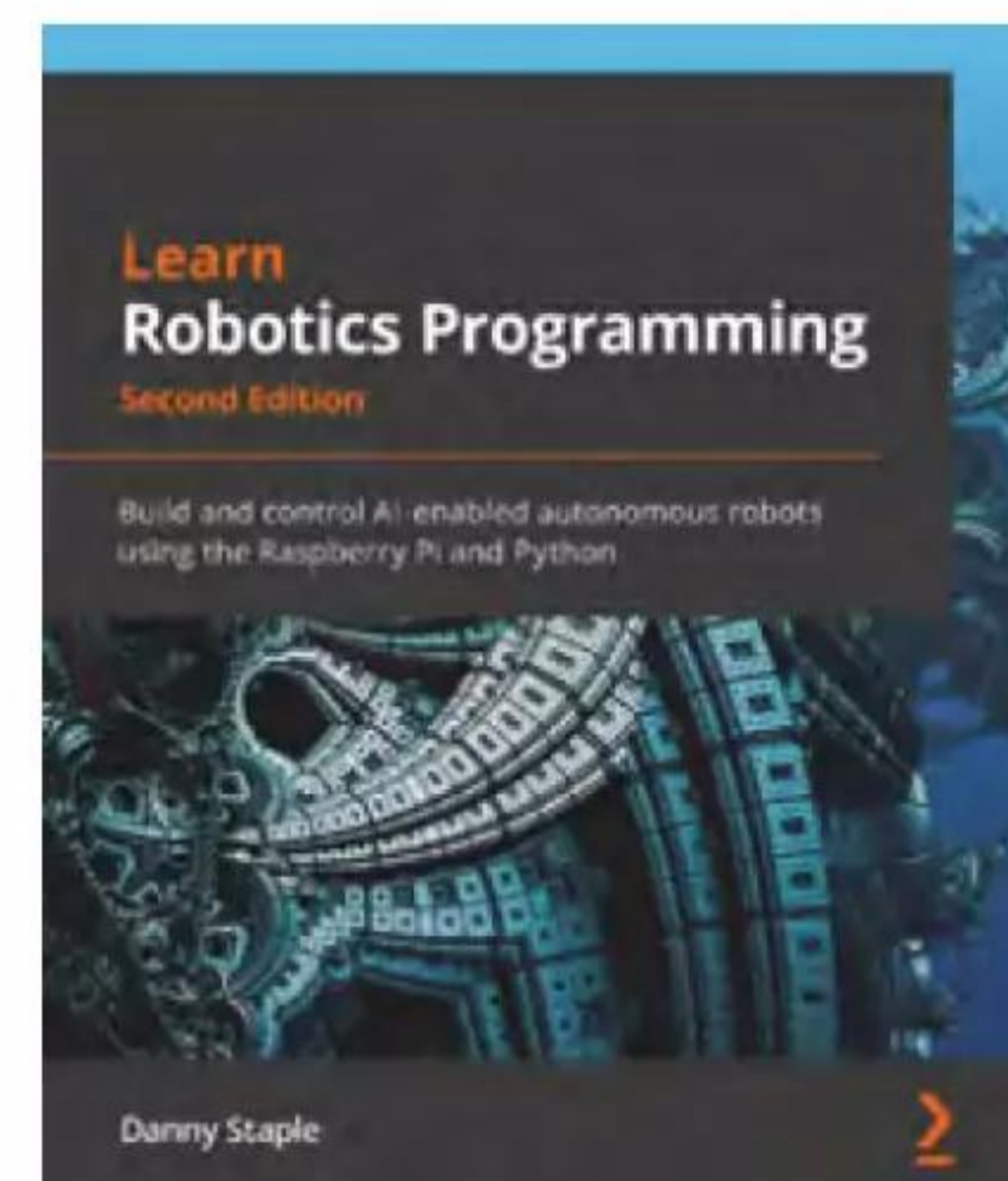

### LEARN ROBOTICS PROGRAMMING, 2ND EDITION

Over 600 pages, Danny Staple demonstrates in detail how to use a Raspberry Pi and Python to program a two-wheeled robot and add a wide range of features to it.

► [magpi.cc/robotprog2](https://magpi.cc/robotprog2)

### LEARN ROBOTICS WITH RASPBERRY PI

Author Matt Timmons-Brown shows you how to build and program a basic robot and customise it with lights, sound, sensors, and a camera. A great beginner's guide.

► [nostarch.com/raspirobots](https://nostarch.com/raspirobots)

### ROBOTICS AT HOME WITH RASPBERRY PI PICO

Danny Staple explores the possibilities of robotics using Raspberry Pi Pico, programming it with MicroPython, and adding features such as object and orientation detection.

► [magpi.cc/robothomepico](https://magpi.cc/robothomepico)

# Free eBook!



Download your copy from  
[hsmag.cc/freecadbook](http://hsmag.cc/freecadbook)



# Nicholas Provenzano

The award-winning Nerdy Teacher who has become one of the leading makerspace authorities in the USA

- > Name **Nicholas Provenzano** | > Occupation **Teacher, makerspace director**
- > Community role **Educator** | > URL **TheNerdyTeacher.com**

**W**e've met Nicholas before at New York Maker Faire, where he was helping out with coding demos at the Raspberry Pi Foundation's booth. It was a nice little demo with components attached to wooden boards and alligator clips to connect everything. As a teacher, one of the first North American Picademy attendees and a big US Raspberry Pi advocate, he was truly in his element.

"I've been a tinkerer for as long as I can remember," Nicholas says. "There are many things I took apart that I could never reassemble in my youth. How things work was something that always fascinated me. We did not have much when I was younger, so my parents would often make toys for us. My brothers and I wanted Castle Greyskull and Snake Mountain bases for our He-Man action figures, but they were too

expensive. My parents built their own versions and they were under the Christmas tree, and we thought they were cooler than the store-bought ones."

## When did you decide to become a teacher?

I was first recognized as being neurodivergent (dyslexic) at university. I struggled with reading and writing, but it was something that I still enjoyed and found ways to make happen despite my unknown issues. Once I was able to put a name on it, get the support I needed, and not feel so bad about myself and how I learned, I was able to be successful. A friend suggested I take an intro to education course and see how I liked it. From there, I found my passion in helping students who have a passion for learning, but struggle like I did. I want to support those learners that never matched the perfect learning profile many people expected from students.

## When did you learn about Raspberry Pi?

I started a design class for grade 11 and 12 students and



> Nicholas came all the way to Cambridge for the fifth birthday party in 2017



◀ A LEGO NES upgraded with a Raspberry Pi so you can play actual games on it

▶ Students working away on the kind of demos shown off at the New York Maker Faire



we would explore problems in the school and find creative ways to solve them. I had never coded or worked with electronics before, so when a student suggested using Raspberry Pi to create an automated system for students to use to check them in and out of the classroom, I was very intrigued. I dove into Python coding and loved what I saw. The first North American

project-based learning, with and without Raspberry Pi, can be executed in a technology-based class and my Literature classes. I spent time with my students exploring the different ways Raspberry Pi could be leveraged to solve problems, and how we can code sensors to interact with Raspberry Pi and observe the environment around us and track that data.

“ I signed up and had one of the very best professional development experiences in my career ”

Picademy was announced shortly after the students introduced me to [Raspberry] Pi and I signed up and had one of the very best professional development experiences in my career.

#### **How did you bring Raspberry Pi into class?**

I took what I learned from Picademy and explored how

“Going to Picademy and learning to code for the first time, and taking that skill into physical computing, is something that will stay with me. Matt Richardson, Carrie Anne Philbin, Ben Nuttall, James Robinson, and others really made an impact on me and how I view instruction and the value of code.” **M**

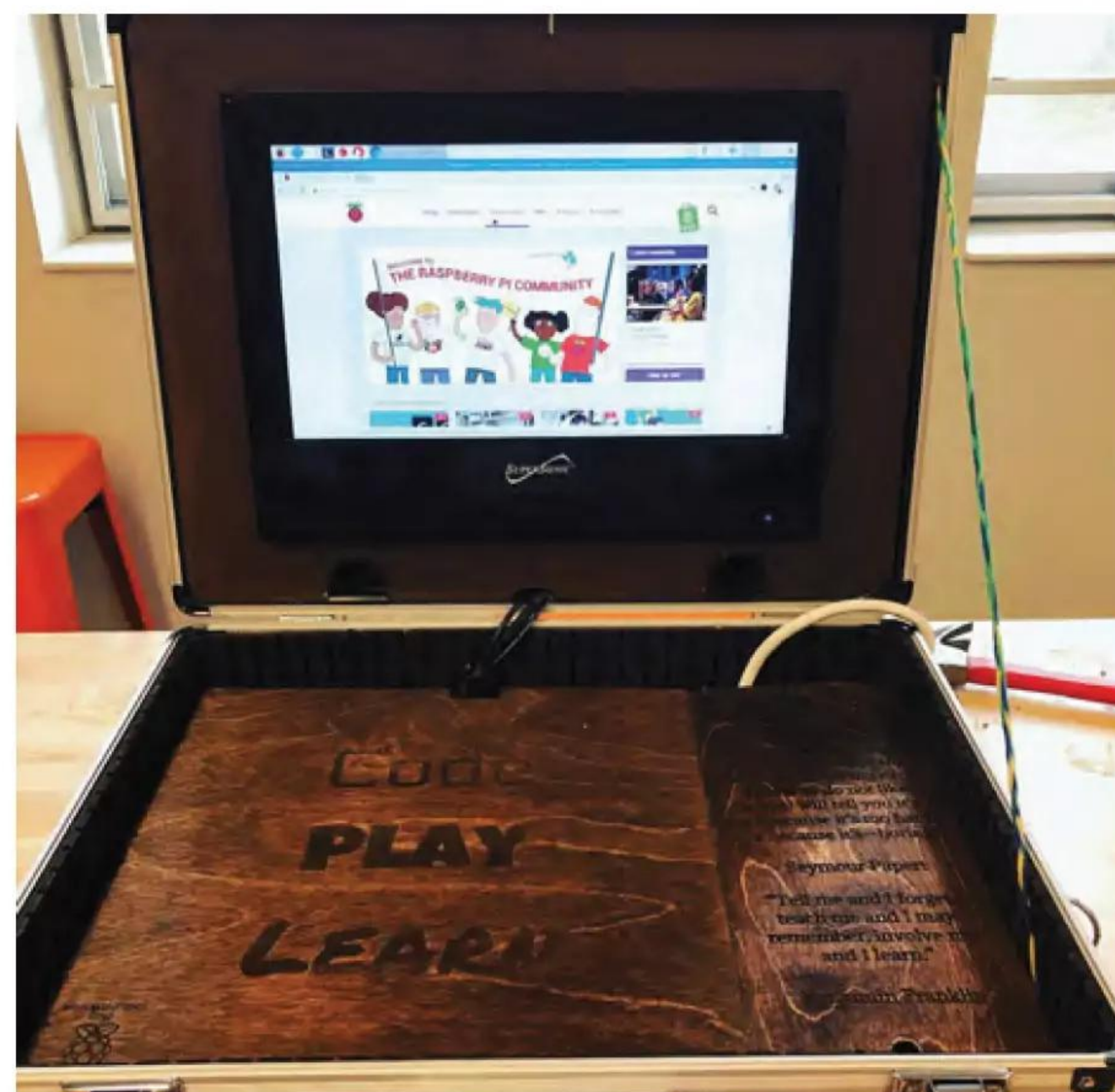

▲ This briefcase laptop has more wood than we'd usually see in a briefcase, but it gives it some retro tech charm

# MagPi Monday

Amazing projects direct from social media!

**E**very Monday we ask the question: have you made something with a Raspberry Pi over the weekend? Every Monday, our followers send us amazing photos and videos of the things they have made.

Here's a selection of some of the awesome things we got sent this month – and remember to follow along at the hashtag #MagPiMonday!

01. The robot from the new *Star Wars* show looks cute
02. This Pico-powered robot is full of features some Raspberry Pi robots don't have
03. Roktrack is something we covered in the last issue, and seeing it tumble down the ramp is cute
04. It's a robot-heavy month it seems, although this tiny robot remote is adorable
05. The Raspberry Pi Store is a wonderful place and, unfortunately, pop-ups are over for the year
06. This is a cool custom 3D printer build with a lot of Raspberry Pi control
07. Collecting weathery data is an excellent goal, and we also find it satisfying
08. We love seeing young people get into video making with stop-motion
09. Using the old Instagram logo makes this a lot better in our opinion

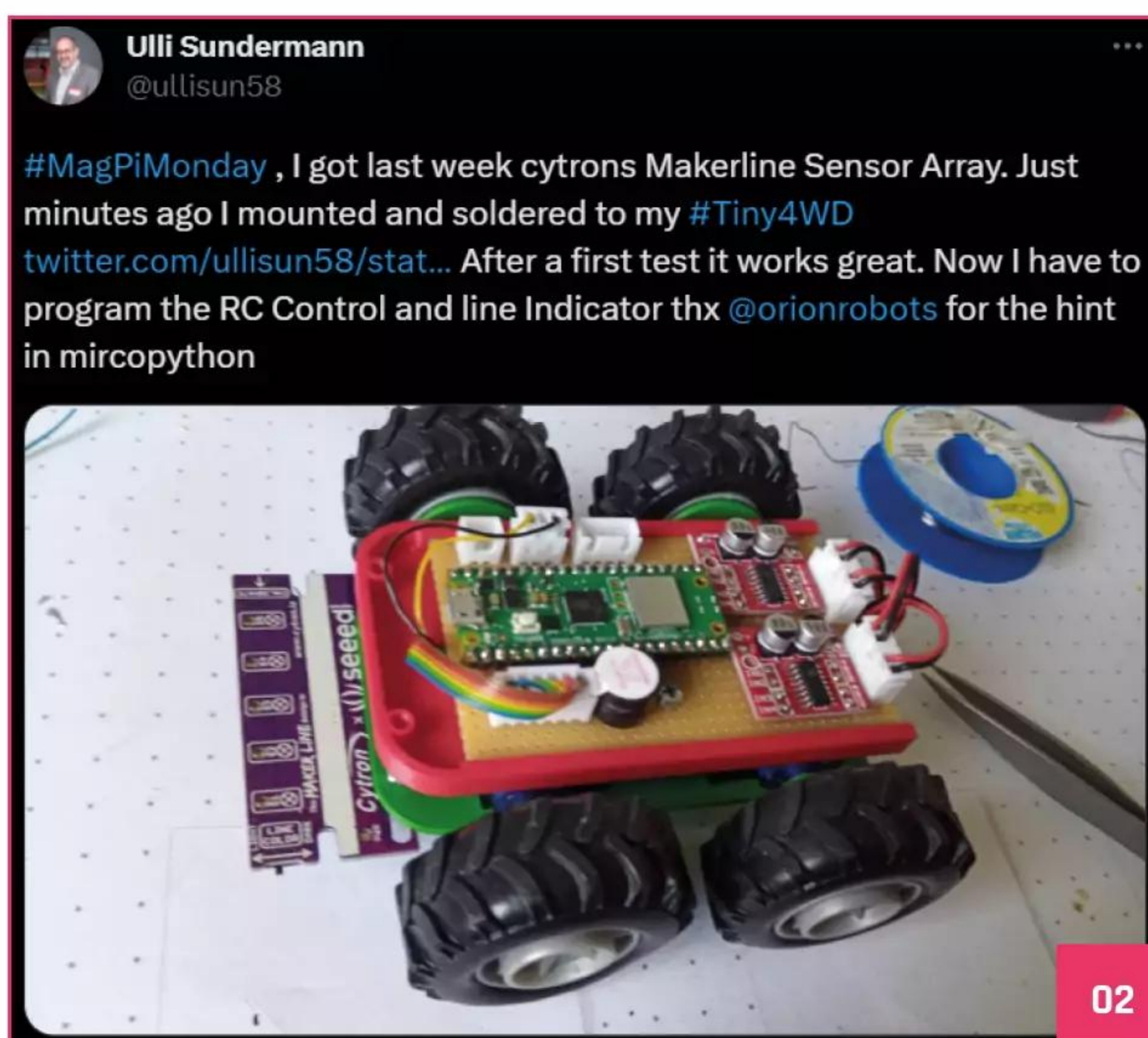
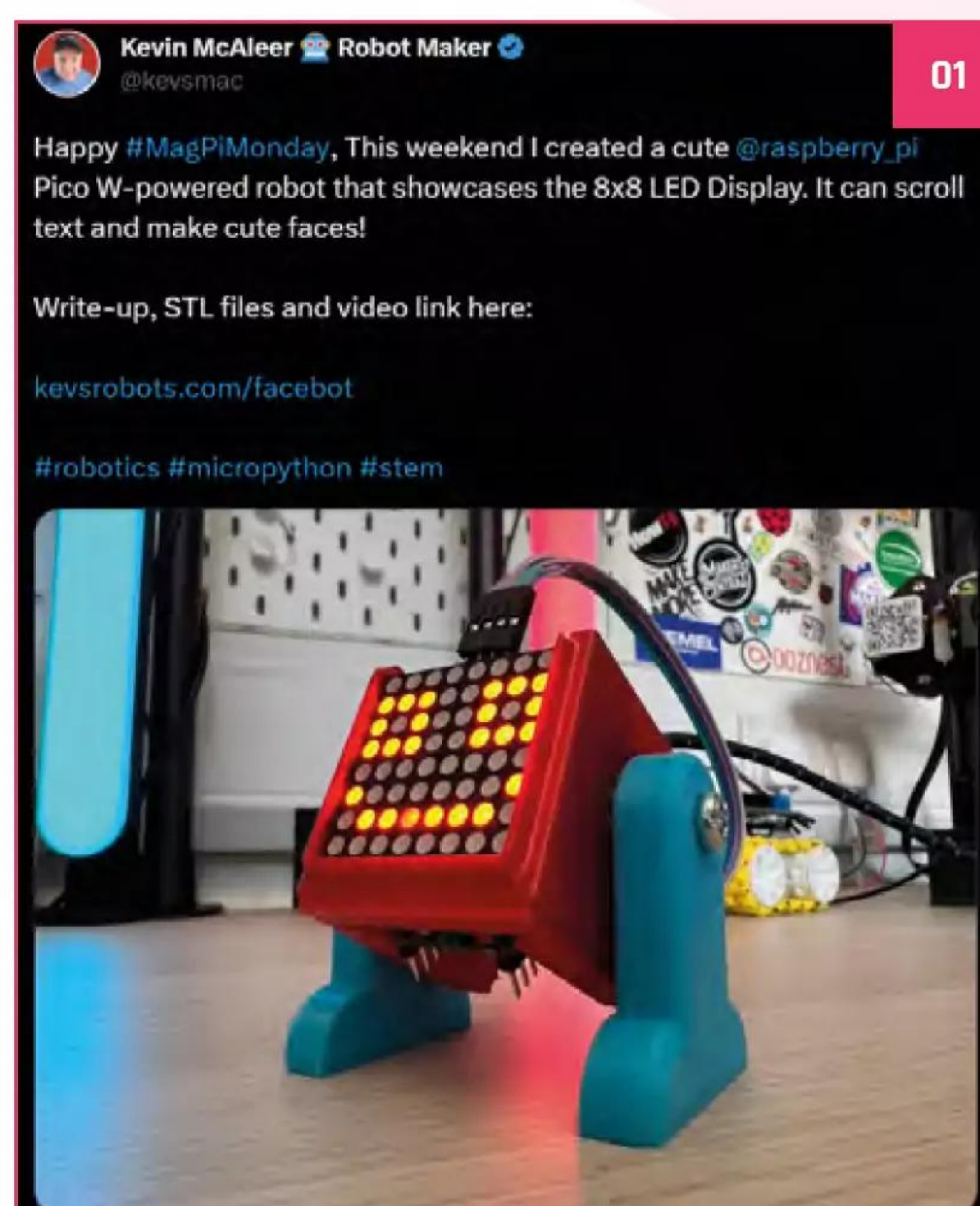

**yuta suito** @yutasuito 03

Happy #MagPiMonday!  
This weekend I released the source for Roktrack, a pylon-guided robotic mower that is being rewritten from Python to Rust. If you are interested in a DIY robotic mower, please take a look. Check it out in the latest Issue 133.  
[github.com/ysuito/roktrack](https://github.com/ysuito/roktrack)



0:18

**TGD** @TGD\_Consulting 04

Happy #MagPiMonday, this is my easy remote control using @Raspberry\_Pi #PicoW #Bluetooth #BLE.  
The first draft of #micropython code to remotely control the #PiMowBot via #BT has been added to this repository @github:  
[github.com/TGD-Consulting...](https://github.com/TGD-Consulting...)  
#make #smart #IoT lawn mower #robot



GIF K

**Simon Prickett** | simonprickett.dev @simon\_prickett 05

Came to visit @Raspberry\_Pi Cambridge store as I was on a quick trip to the city for other things. Got 12 Pico WH and one more Pi 4 8gb.



**Dr Footleg - Roboteer** @drfootleg@fosstodon.org @drfootleg 06

Posting my #MagPiTuesday entry for #MagPiMonday on Wednesday (it's been a busy week).  
I finished building my 3D printed hot-end 3D printer running Klipper Screen on a Raspberry Pi 3b+ with the 7" touchscreen. LED disk indicates temperatures. #PiCam3 for remote monitoring of jobs.



**D Everitt** @deverittuk 07

#MagPiTuesday?  
Slightly behind on Twitter this week due to a broken phone :(  
But... this weekend, I launched a new Enviro Pico W weather station for collecting all weathery things data purely for my own satisfaction / home automation integrations :D



**Scott Young** @thebotmakes 08

Me & Phina (?) built on my Timelapse stuff and some animation she'd been working on at school to branch out into stop motion. It's not A Grand Day Out yet but it's a start! #MagPiMonday



ALT

**Simon Smith** 19h 09

Just dug my photo booth I made out the loft in hope of reviving it. Made a couple years back running a pi and pi camera with live uploads to a Wordpress website which also has a iOS companion app to view/upload photos



# Events in pictures: Melbourne Raspberry Pi Makers Meetup

Community and official events in the wild

**A** regular on our events pages, the Melbourne Raspberry Pi Makers Meetup is a monthly gathering of makers. Jam holders get free swag and the organiser Trevor Warren (who we interviewed in issue 128: [magpi.cc/128](http://magpi.cc/128)) gives it out to folks who do a show and tell of their projects.

01. People give talks and show off their latest projects
02. We would love to have access to this many 3D printers all the time
03. This happy chappy is a piggy bank... a bee-gy bank?
04. Free swag of excellent magazines always goes down well



FIND OUT ABOUT NEXT  
MONTH'S EVENTS AND  
POP-UP ON  
**PAGE 92**





# Best of the rest!

Other cool things we saw using Raspberry Pi this month

## Universal wait times

We have heard whispers of Raspberry Pi being used in major theme parks, but this is our first bit of proof. Also, peep that ancient Raspbian desktop, it's been a while since we've seen it ourselves.



► [magpi.cc/universal](http://magpi.cc/universal)

## Unicode character display



This Pico-powered device is a cool way of displaying unicode using physical switches. It then shows what that arrangement makes and how to create it on a keyboard. Very cool.

► [magpi.cc/unicodeinput](http://magpi.cc/unicodeinput)

# WE MAKE, YOU CREATE.

## MODULAR & EXPANDABLE



DESIGNED FOR  
**RASPBERRY PI ZERO 2 W**  
MOST ADVANCED MODULAR RASPBERRY PI ZERO 2 W ALUMINUM CASE.



HDMI•USB MODULE



2.8" DISPLAY MODULE



LAN•USB MODULE

ARGON ONE M.2		ARGON EON	
ARGON ONE V2		ARGON NEO	
ARGON PWR		ARGON POLY+ VENTED	

DESIGNED FOR  
**RASPBERRY PI BOARDS**

# Your Letters



## Python book reprints

**I have a question: will the book *Create Graphical User Interfaces with Python* be available in the future in print? I have noticed it is currently sold out.**

**Bernd** via email

It will get a reprint in the future, however, we don't have a timeline to give you for that right now. For the moment, you're more than welcome to print off your own copy using the free PDF available at: [magpi.cc/books](https://magpi.cc/books).



## Next Raspberry Pi

**When will Raspberry Pi 5 be out? I had assumed the chip shortages were to blame for no new Raspberry Pi, but it's been a while since they were sorted. Can we get any idea of when?**

**Ari** via Facebook

As you may have seen, if you didn't skip ahead in this issue, Raspberry Pi 5 is out at the end of October. It's been a bit of a hard secret to keep as it is very, very cool but, hopefully, it will have been worth the wait. We think it was at least.

## Native games

Is anyone making games only for Raspberry Pi? I have used mine to play retro games, but I wondered if there were newer games for it? I mean, I'm not expecting Baldurs Gate 3 to run on it... unless...?

Gita via Threads

There are some games that have been built for Raspberry Pi – such a SuperTuxKart, the Lemmings clone Pingus, Micropolis, even DOOM. However, not many are being made specifically with Raspberry Pi in mind.

The PicoSystem ([magpi.cc/picosystem](https://magpi.cc/picosystem)) is an RP2040 handheld made by our friends at Pimoroni and there are many cool games that have been made specifically for it. It's quite a good system for programming your own games too.

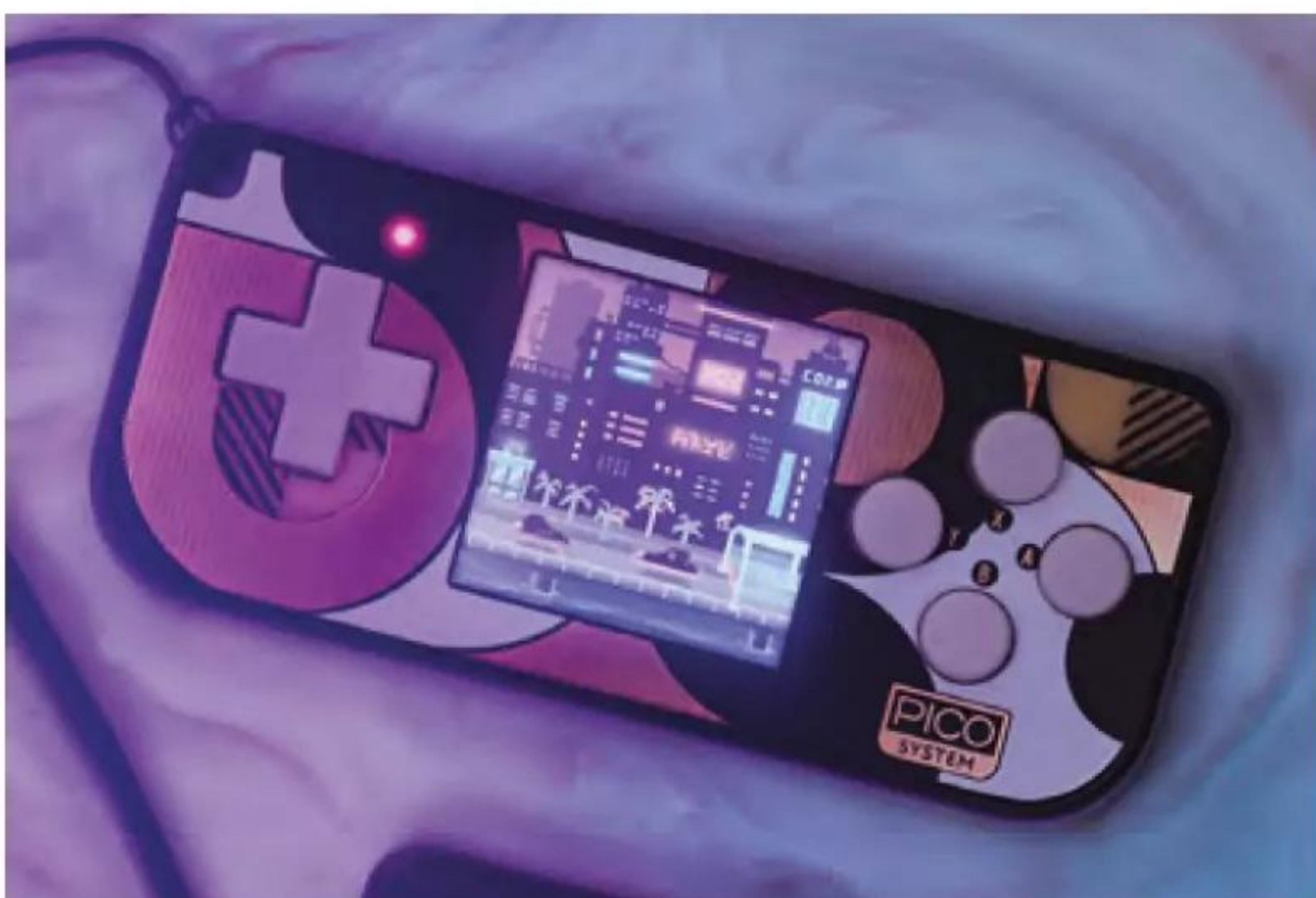

▲ This tiny handheld is very cool and very open for developing on

## Contact us!

- Mastodon [magpi.cc/mastodon](https://magpi.cc/mastodon)
- Threads [@themagpimag](https://@themagpimag)
- Facebook [magpi.cc/facebook](https://magpi.cc/facebook)
- Email [magpi@raspberrypi.com](mailto:magpi@raspberrypi.com)
- Online [forums.raspberrypi.com](https://forums.raspberrypi.com)

# USA SPECIAL! 6 ISSUES FOR \$43



## FREE RASPBERRY PI PICO W



Subscribe online:  
[magpi.cc/subscribe](https://magpi.cc/subscribe)

Continuous credit card orders will auto-renew at the same price unless cancelled. A free Pico W is included with all subscriptions. This is a limited offer. Not included with renewals. Offer subject to change or withdrawal at any time.



# Community Events Calendar

Find out what community-organised Raspberry Pi-themed events are happening near you...

## 01. Riverside Raspberry

- 📅 Monday 9 October
- 📍 3600 Lime Street, Riverside, CA, USA
- ▶ [magpi.cc/riverside134](http://magpi.cc/riverside134)

Riverside Raspberry is a California-based enthusiast group that's been meeting up for almost a decade. This group will appeal to thinkers and tinkerers, the scientifically curious, software developers looking to get into embedded development, or anyone young or old that has a knack for tech in general.

## 02. Cornwall Tech Jam

- 📅 Saturday 14 October
- 📍 Wadebridge Pavillion, Egloshayle, UK
- ▶ [magpi.cc/ctj134](http://magpi.cc/ctj134)

Cornwall Tech Jams are run by volunteers working in IT and education throughout Cornwall. They are supported by Software Cornwall, its members, and other local businesses. Our volunteers give their own time and expertise to plan each Cornwall Tech Jam and to the regular maintenance of all our equipment.



## 03. Raspberry Pi Jam Mombasa

- 📅 Friday 20 October
- 📍 Tech Kidz Africa, Mombasa, Kenya
- ▶ [magpi.cc/rpjm134](http://magpi.cc/rpjm134)

Raspberry Pi Jam Mombasa is a one-day event for students, teachers, and enthusiasts of robotics and AI. The Jam will feature workshops, demonstrations, and hands-on activities.

## 04. Patchogue Raspberry Jam

- 📅 Sunday 22 October
- 📍 Patchogue-Medford Library, Patchogue, NY, USA
- ▶ [magpi.cc/ptj134](http://magpi.cc/ptj134)

Come learn about digital making with Raspberry Pi. The library's Raspberry Pi computers and beginner activities will be available. Already have a Raspberry Pi? Bring it and show us your projects! Suitable for ages 8 and up.

## FULL CALENDAR

Get a full list of upcoming community events here:  
[magpi.cc/events](http://magpi.cc/events)



## Where can you find Raspberry Pi next?

- Next location **Maker Faire Bay Area**
- Where **Mare Island Naval Shipyard, Mare Island, CA, USA**
- When **Friday 13 October to Sunday 15 October**

**T**he Raspberry Pi team is eager to be back at **Maker Faire Bay Area after an extended hiatus.**

Come see our latest products and show us what you've made with Raspberry Pi technology. We plan to have a booth with hands-on demos and swag during the first weekend of the event, 13–15 October. Keep an eye out for roaming Raspberry Pi team members on the second weekend, 20–22 October.

[magpi.cc/bamf23](http://magpi.cc/bamf23)

# WIN ONE OF FIVE RASPBERRY PI 5 8GB

Raspberry Pi 5 is out in one month, and you can have a chance to be one of the first to own one with this month's competition. We can probably strong-arm Eben to sign the box too!

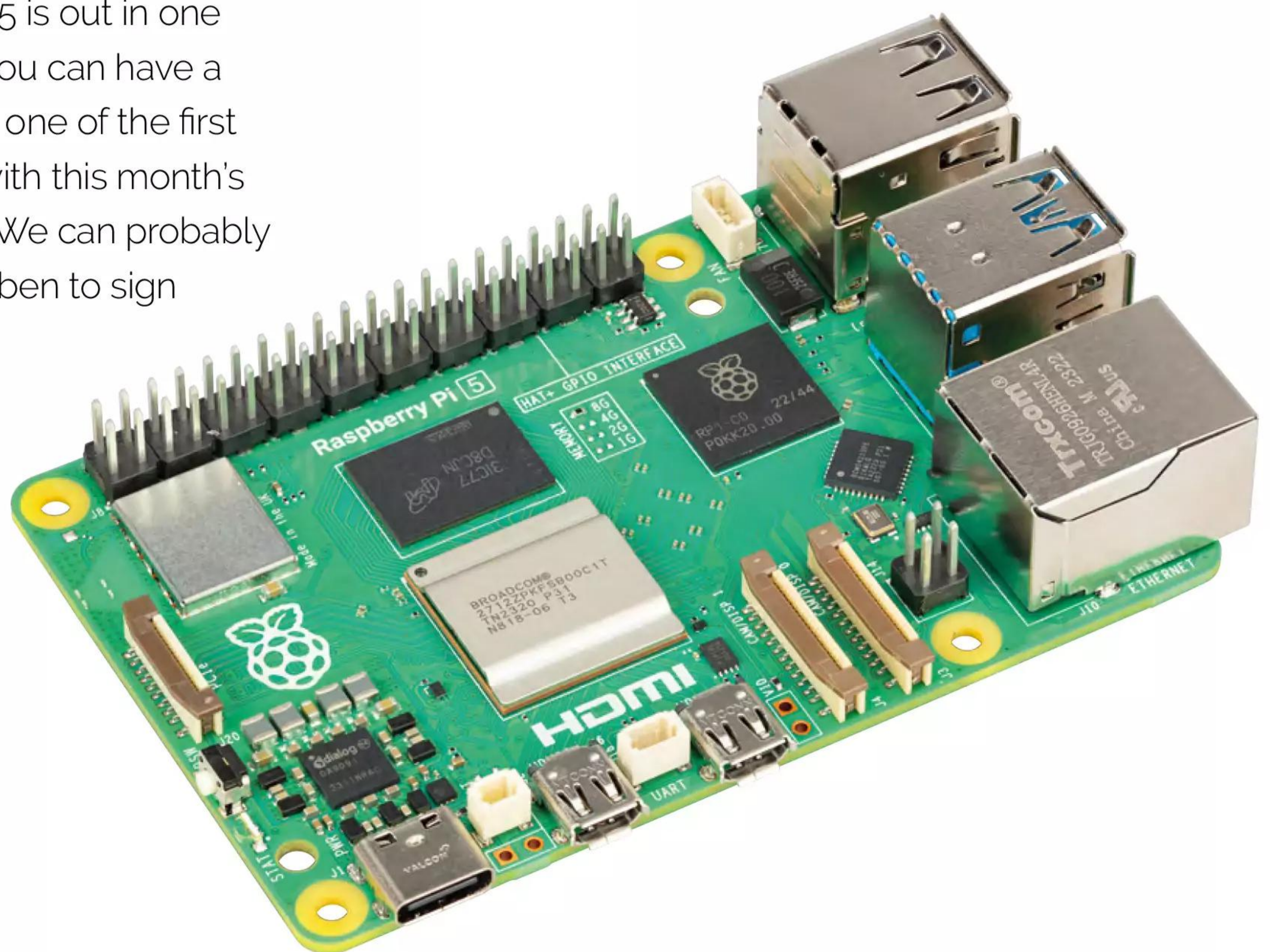

Head here to enter: [magpi.cc/win](https://magpi.cc/win) | Learn more: [magpi.cc/raspberrypi5](https://magpi.cc/raspberrypi5)

## Terms & Conditions

Competition opens on **28 September 2023** and closes on **26 October 2023**. Prize is offered to participants worldwide aged 13 or over, except employees of Raspberry Pi Ltd, the prize supplier, their families, or friends. Winners will be notified by email no more than 30 days after the competition closes. By entering the competition, the winner consents to any publicity generated from the competition, in print and online. Participants agree to receive occasional newsletters from The MagPi magazine. We don't like spam: participants' details will remain strictly confidential and won't be shared with third parties. Prizes are non-negotiable and no cash alternative will be offered. Winners will be contacted by email to arrange delivery. Any winners who have not responded 60 days after the initial email is sent will have their prize revoked. This promotion is in no way sponsored, endorsed or administered by, or associated with, Instagram, Facebook, Twitter or any other companies used to promote the service.

# HackSpace

TECHNOLOGY IN YOUR HANDS

THE **MAGAZINE**  
FOR THE **MODERN MAKER**



SUBSCRIBE AND  
**SAVE** UP TO  
**35%**  
on the cover price



ISSUE #71

# OUT NOW

[hsmag.cc](http://hsmag.cc)



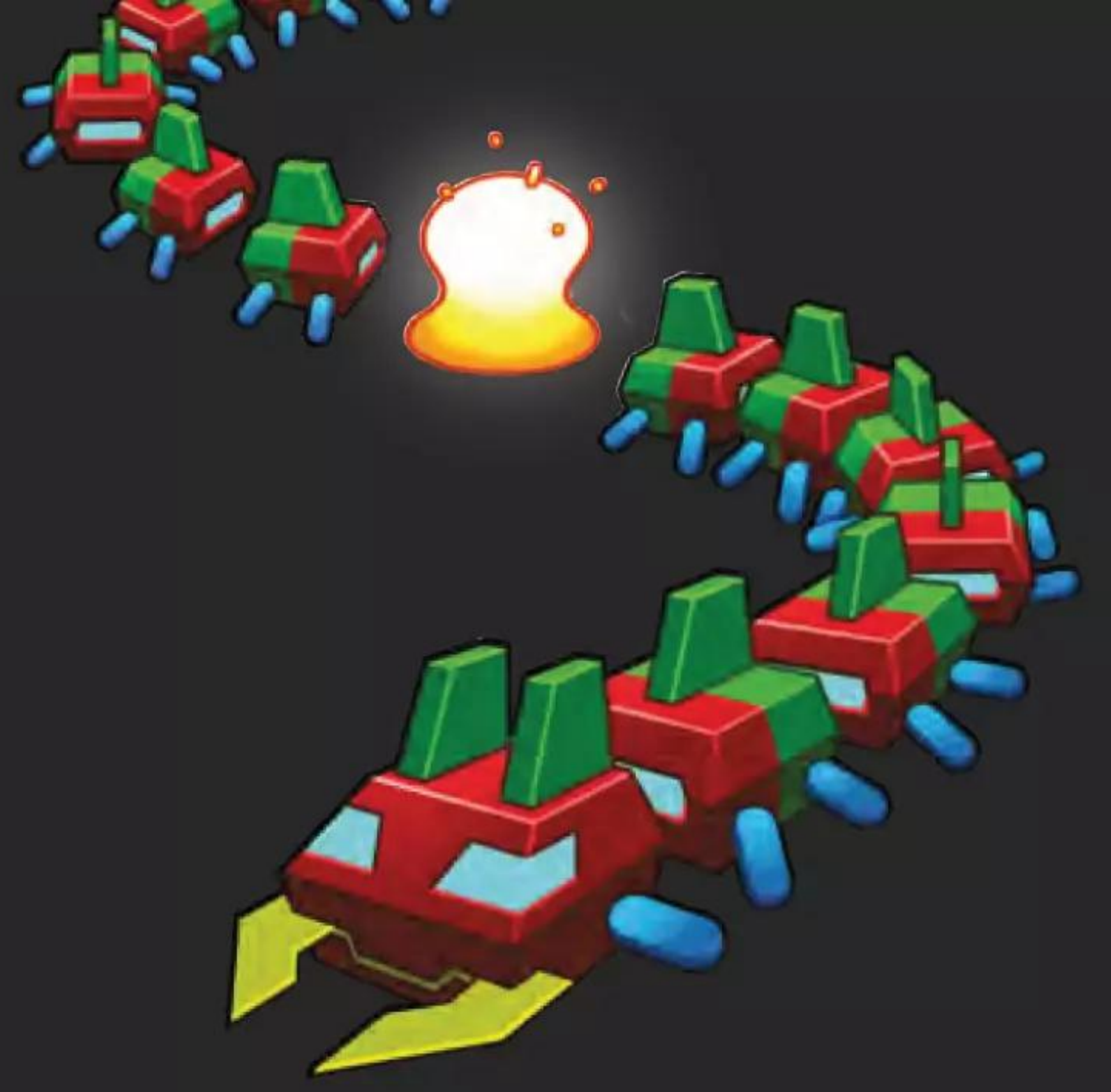

# CODE THE CLASSICS VOLUME 1

This stunning 224-page hardback book not only tells the stories of some of the seminal video games of the 1970s and 1980s, but shows you how to create your own games inspired by them using Python and Pygame Zero, following examples programmed by Raspberry Pi founder Eben Upton.

- *Get game design tips and tricks from the masters*
- *Explore the code listing and find out how they work*
- *Download and play game examples by Eben Upton*
- *Learn how to code your own games with Pygame Zero*

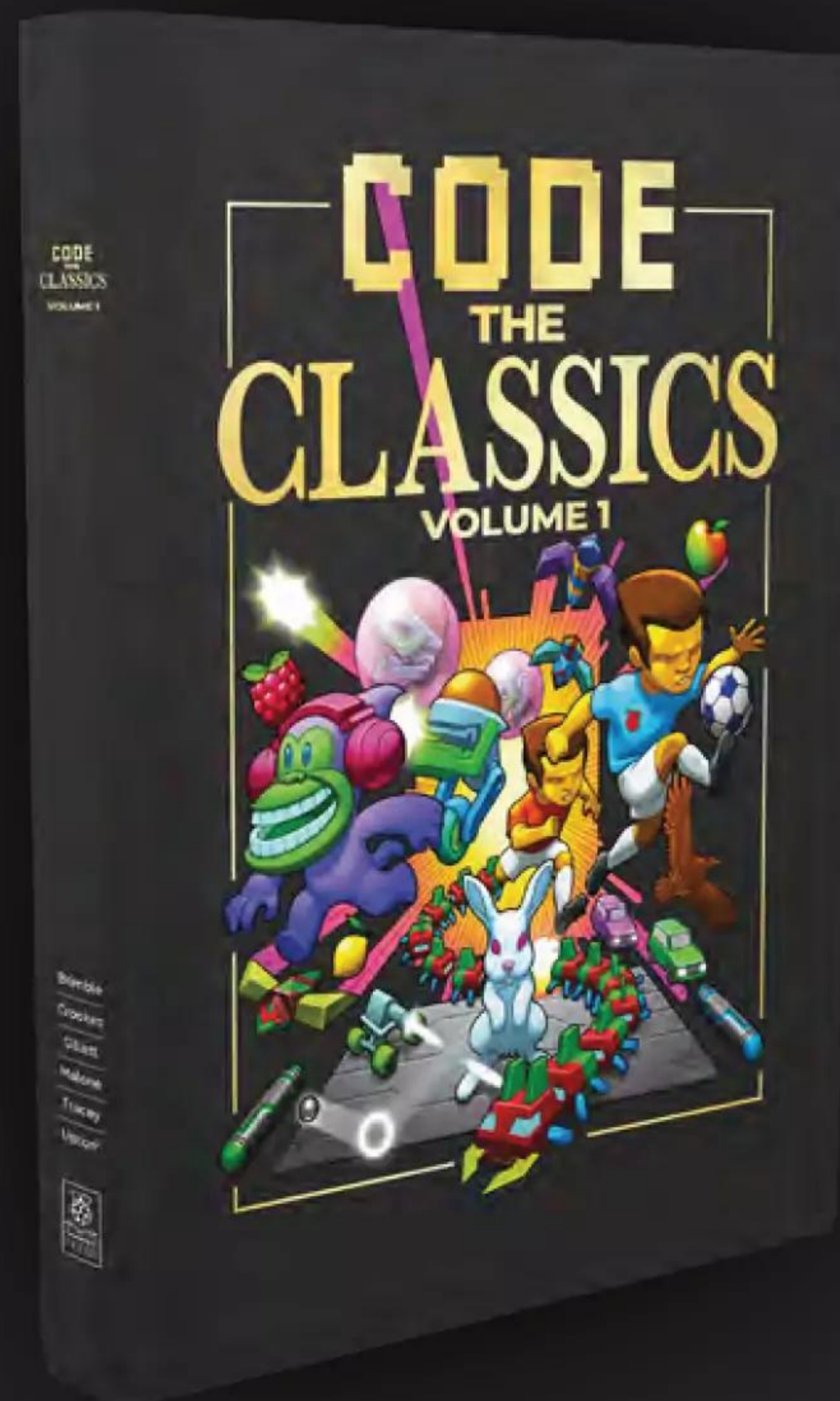

Available now [hsmag.cc/store](https://hsmag.cc/store)





# Raspberry Pi **5**

## RELEASED

Raspberry Pi 5 hits the shelves! We look at getting started with your new computer



THE MAGPI #135  
ON SALE 26 OCTOBER

**Plus!**

50 Raspberry Pi Projects

Build a mecanum robot

Using Ubuntu on Raspberry Pi 5

DON'T MISS OUT!  
[magpi.cc/subscribe](https://magpi.cc/subscribe)

TWITTER @TheMagPi

FACEBOOK [fb.com/MagPiMagazine](https://fb.com/MagPiMagazine)

EMAIL [magpi@raspberrypi.com](mailto:magpi@raspberrypi.com)

### EDITORIAL

#### Editor

Lucy Hattersley  
[lucy@raspberrypi.com](mailto:lucy@raspberrypi.com)

#### Features Editor

Rob Zwetsloot  
[rob@raspberrypi.com](mailto:rob@raspberrypi.com)

#### Sub Editor

Nicola King

### ADVERTISING

Charlotte Milligan  
[charlotte.milligan@raspberrypi.com](mailto:charlotte.milligan@raspberrypi.com)  
+44 (0)7725 368887

### DESIGN

[criticalmedia.co.uk](https://criticalmedia.co.uk)

#### Head of Design

Lee Allen

#### Designer

Sam Ribbits

#### Illustrator

Sam Alder

### CONTRIBUTORS

David Crookes, Rosie Hattersley, Nicola King, Phil King, Rob Miles, David Plowman, Stewart Watkiss

### PUBLISHING

#### Publishing Director

Brian Jepson  
[brian.jepson@raspberrypi.com](mailto:brian.jepson@raspberrypi.com)

#### Director of Communications

Liz Upton

#### CEO

Eben Upton

### DISTRIBUTION

Seymour Distribution Ltd  
2 East Poultry Ave,  
London EC1A 9PT  
+44 (0)207 429 4000

### SUBSCRIPTIONS

Unit 6 The Enterprise Centre  
Kelvin Lane, Manor Royal,  
Crawley, West Sussex, RH10 9PE  
+44 (0)1293 312193  
[magpi.cc/subscribe](https://magpi.cc/subscribe)  
[magpi@subscriptionhelpline.co.uk](mailto:magpi@subscriptionhelpline.co.uk)



This magazine is printed on paper sourced from sustainable forests and the printer operates an environmental management system which has been assessed as conforming to ISO 14001.

The MagPi magazine is published by Raspberry Pi Ltd, Maurice Wilkes Building, St. John's Innovation Park, Cowley Road, Cambridge, CB4 0DS. The publisher, editor, and contributors accept no responsibility in respect of any omissions or errors relating to goods, products, or services referred to or advertised in the magazine. Except where otherwise noted, content in this magazine is licensed under

a Creative Commons Attribution-NonCommercial-ShareAlike 3.0 Unported (CC BY-NC-SA 3.0).  
ISSN: 2051-9982.





# Five

A new generation of Raspberry Pi means huge things for **Rob Zwetsloot**

**W**orking at a very cool technology company is fantastic – until you have to keep your excitement for a new product a secret from everyone who you know would love to hear about it. It’s a big weight off my shoulders that I can now freely talk about Raspberry Pi 5 (well, not as I write this, after the issue is out) and why y’all should be excited about it too.

I’m looking at mine on my desk right now and honestly, it’s just very nice and shiny. The smooth routed PCB, the clean circuit lines running

“ A lot of people here at Raspberry Pi are very excited for the addition of PCI Express ”

along the board, and the low-profile of the soldered parts. You hear about the story of Steve Jobs asking for the Apple II chips to be laid out in an aesthetically pleasing way, and it was a bit silly because folks wouldn’t be really seeing it. However, when your computer comes as just a board it

does make a lot more sense to be pretty.

## Power of potential

A lot of people here at Raspberry Pi are very excited for the addition of PCI Express. NVME storage is one thing, a very cool thing that will make for some very low-profile home file servers, but we’re looking forward to seeing what people connect to it over time. How soon until someone has an RTX 4090 hooked up to it? Then we’ll truly be playing with power.

While I’ll definitely be using it myself for retro game stuff, desktop computing, and media server stuff (the new VideoCore is very nice!), what I’m most excited for is to see what folks in the community come up with. Alasdair Allan, Head of Documentation here at Raspberry Pi,

has already mentioned wanting to do more machine learning tests on it using the extra oomph the chipset provides. What else will you all come up with? As always, flood *The MagPi* social media accounts with what you do make so that I can see.

## Out soon

I have to remind myself that, although everyone knows about it, it’s not out just yet! For the next issue, we’re already working on cool stuff you can do with Raspberry Pi 5, so you will be well fed with inspiration and tutorials to get you started. In the meantime, what do you want to make with Raspberry Pi 5? We’re all ears/eyes. Drop us a social media message or an email – we’re on Mastodon, Threads, Facebook, etc. 

AUTHOR

## Rob Zwetsloot

Rob has been seeing parts of Raspberry Pi 5 come together for nearly eight years now and is very excited it’s finally here

[magpi.cc](https://magpi.cc)

HiPi.io

# HIGHPI PRO

———— The new case from the HiPi.io team ————.



- Rapid tool-free assembly and disassembly
- Large internal volume for HATs
- Compatible with Pi 2/3/4
- Multiple lid options
- Passive & Active Cooling options

- Secure microSD card cover
- VESA mount support
- Molding-configurable output ports customizable for volume orders
- Printed logo for your branding

Available at these great Pi stores:



Contact your favorite Pi store if it's not listed here

# PiKVM

Manage your servers or workstations remotely

A **cost-effective** solution for data-centers, IT departments or remote machines!



**PiKVM HAT**  
for DIY and custom projects



**Pre-Assembled version**

- Real-time clock with rechargeable super capacitor
- OLED Display
- Bootable virtual CD-ROM & flash drive
- Serial console
- Open-source API & integration
- Open-source software

Available at the main Raspberry Pi resellers



Reseller suggestions and inquiries:  
**wholesale@hipi.io**