

BUY IN PRINT WORLDWIDE! magpi.cc/store

The MagPi

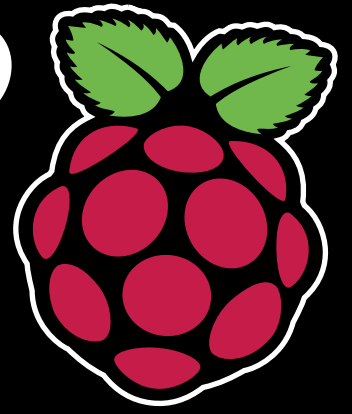

The official Raspberry Pi magazine

Issue 68

April 2018

raspberrypi.org/magpi

RASPBERRY PI 3B+

Fully Benchmarked Engineering Team Interview Perfect Project Ideas

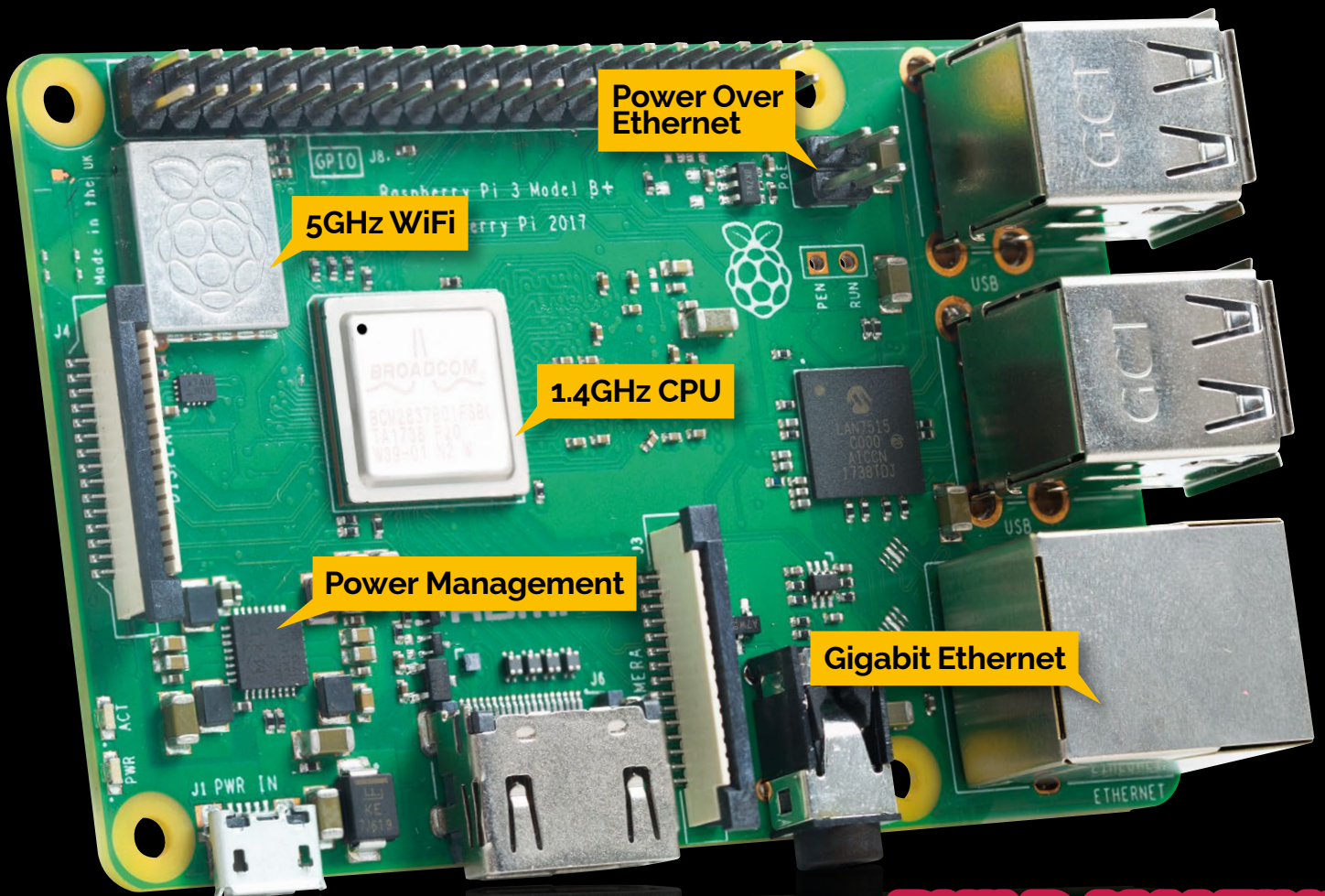

Also inside:

- CREATE A RASPBERRY PI SMART FAN
- THE NINTENDO SWITCH-STYLE CONSOLE
- MAKE YOUR OWN MIDI DRUM SEQUENCER
- CODE A MINECRAFT HOUSE WITH PYTHON



BUILD AMAZING BATTLE ROBOTS

How to win at Pi Wars 2018

GLOBAL DELIVERY
magpi.cc/store





CanaKit Raspberry Pi 3 Ultimate Starter Kit

Model B | 1 GB RAM | 1.2 GHz | Quad-Core CPU

- > Learn to Code
- > Explore Computing
- > Get started with Electronics

KIT INCLUDES RASPBERRY PI 3 AND ...

PREMIUM CASE & HEAT SINKS 	2.5A POWER ADAPTER 	32 GB CLASS 10 MICROSD CARD PRE-LOADED WITH OPERATING SYSTEM	USB MICROSD CARD READER 	PREMIUM HDMI CABLE 	QUICK-START GUIDE
GPIO TO BREADBOARD INTERFACE BOARD 	RIBBON CABLE 	FULL-SIZE BREADBOARD 	JUMPERS MALE TO MALE & MALE TO FEMALE	LEDs 	RESISTORS & PUSH-BUTTONS

Available for worldwide shipping at:

WWW.CANAKIT.COM

Raspberry Pi Zero W
Now available at CanaKit!



WELCOME TO THE OFFICIAL MAGAZINE

It's always exciting when Raspberry Pi releases a new model. The Raspberry Pi 3 Model B+ (or Pi 3B+ for short) sports a revised quad-core system-on-chip which now runs faster, at 1.4GHz.

It's a meaningful speed boost. Everything feels a little snappier. Big programs like Mathematica load faster and online videos play more smoothly.

Raw power is always a headline grabber, but we find it's the other tweaks that make the new Raspberry Pi truly interesting.

Eagle-eyed readers will already have spotted the chrome-plating around the wireless networking chip. This now supports dual-band (2.4 GHz and 5GHz) wireless networking, enabling faster data transmission speeds from wireless networks.

Even more exciting is the long-awaited inclusion of Gigabit Ethernet (albeit limited via the USB channel). There's now also Power over Ethernet (PoE) via a new official HAT accessory. PoE is something the community has wanted for a long time; it enables the Raspberry Pi 3B+ to be deployed on a network without requiring a separate power supply.

Many readers are already thinking of quirky uses for a networked Raspberry Pi that works independently of a mains supply.

But let's not forget the speed boost. The new speed is impressive. Turn to page 16 to read all about the new Raspberry Pi 3B+, including benchmarks, real-world testing, and project ideas.

Lucy Hattersley
Editor

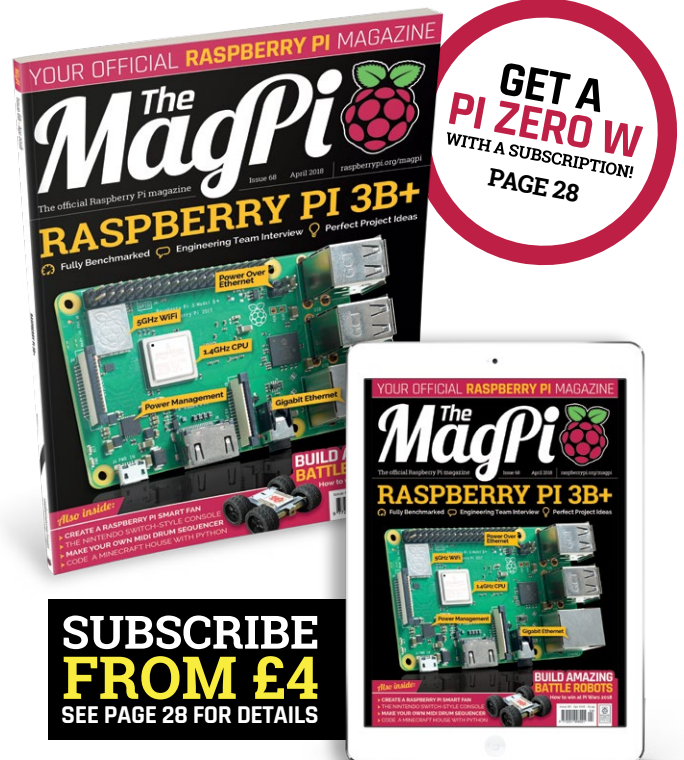

THIS MONTH:

16 RASPBERRY PI 3B+

Learn more with speed tests and team interviews

40 MAKE A MIDI SEQUENCER

Create your own drum machine with Raspberry Pi

54 BUILD A MINECRAFT HOUSE

Build the virtual house of your dreams in Minecraft Pi

64 BUILD AMAZING BATTLE ROBOTS

Win Pi Wars 2018 with our guide to amateur robotics

FIND US ONLINE raspberrypi.org/magpi

GET IN TOUCH magpi@raspberrypi.org

The MagPi

Available on the App Store

GET IT ON Google Play

CC BY NC SA

recycle
When you have finished with this magazine, please recycle it.

EDITORIAL

Editor: **Lucy Hattersley**
lucy@raspberrypi.org
Features Editor: **Rob Zwetsloot**
rob.zwetsloot@raspberrypi.org
Sub Editors: **Phil King** and **Jem Roberts**

DISTRIBUTION

Seymour Distribution Ltd
2 East Poultry Ave
London
EC1A 9PT | +44 (0)207 429 4000

DESIGN

Critical Media: criticalmedia.co.uk
Head of Design: **Dougal Matthews**
Designers: **Mike Kay** and **Lee Allen**
Illustrator: **Sam Alder**

SUBSCRIPTIONS

Raspberry Pi Press
Mann Enterprises, Unit E, Brocks
Business Centre, Haverhill, CB9 8QP
magpi.cc/subscribe

PUBLISHING

For advertising & licensing:
Publishing Director: **Russell Barnes**
russell@raspberrypi.org | +44 (0)7904 766523
Director of Communications: **Liz Upton**
CEO: **Eben Upton**

CONTRIBUTORS

Alex Bate, Brian Beuken, Mike Cook, David Crookes, Gareth Halfacree, Magdalena Jadach, Steve Martin, Nicola King, Jeroen Peters, Matt Richardson, Bartłomiej Rutkowski, Richard Smedley, Clive Webster

This magazine is printed on paper sourced from sustainable forests and the printer operates an environmental management system which has been assessed as conforming to ISO 14001.

The MagPi magazine is published by Raspberry Pi (Trading) Ltd., 30 Station Road, Cambridge, CB1 2JH. The publisher, editor, and contributors accept no responsibility in respect of any omissions or errors relating to goods, products or services referred to or advertised in the magazine. Except where otherwise noted, content in this magazine is licensed under a Creative Commons Attribution-NonCommercial-ShareAlike 3.0 Unported (CC BY-NC-SA 3.0). ISSN: 2051-9982.





Contents

Issue 68 April 2018

raspberrypi.org/magpi

TUTORIALS

- > **PI 101 – INSTALL UBUNTU 38**
How to use Ubuntu on Raspberry Pi
- > **BUILD A DRUM SEQUENCER 40**
Pi Bakery is back with another MIDI music project
- > **SET UP A DOCKER CONTAINER 48**
Install Plex and learn about Docker in the process
- > **AUTOMATE A DESK FAN 52**
The Pi Fan is a temperature-controlled USB fan
- > **MAKE A HOUSE IN MINECRAFT 54**
Create a house with the touch of a button
- > **MAKE GAMES WITH C PART 4 58**
This time we're manipulating images

COVER FEATURE

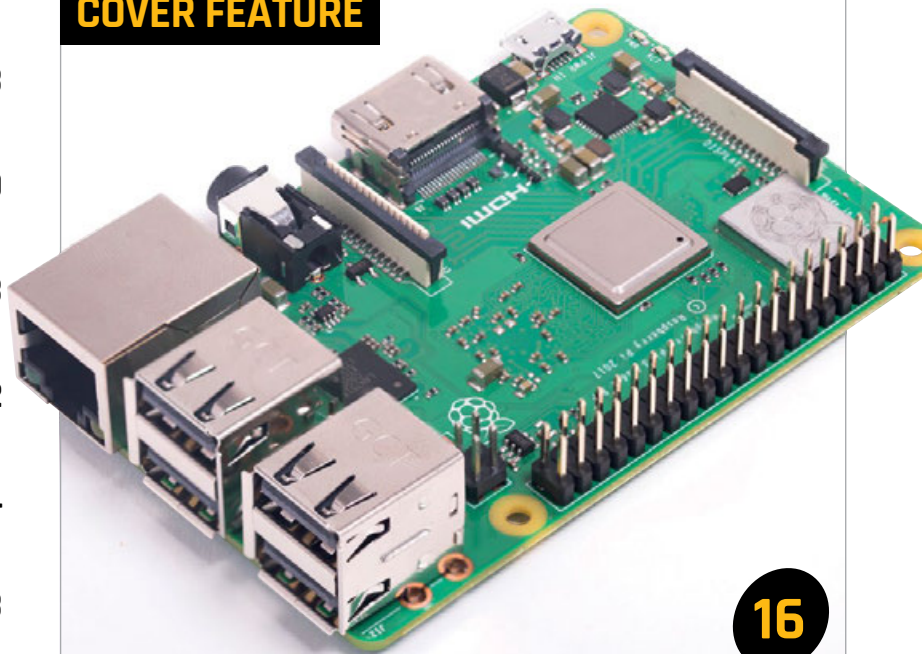

16

RASPBERRY PI 3B+

IN THE NEWS

CODE CLUB WESTMINSTER



MPs, Lords, and kids get their hands on Pi

06

RASPBERRY FIELDS



Official two-day festival announced!

10

ROBO-CAT

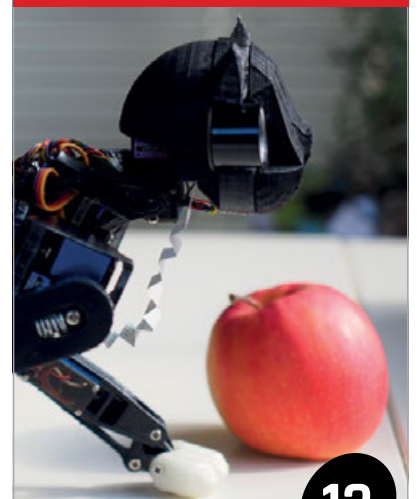

Truly the cat's meow

13

THE BIG FEATURE



PI WARS

Everything you need to know about the robotic contest

64

WIN! 10 MEARM PI KITS



IN ASSOCIATION WITH:
Mime Industries

97

YOUR PROJECTS



30

AMBIENT TV

Creating an eye-catching visual effect on your TV

REGULARS

- > NEWS 06
- > TECHNICAL FAQ 62
- > BOOK REVIEWS 80
- > FINAL WORD 98

COMMUNITY

- > RPI ZWEI INTERVIEW 84
Making a music album with the Pi as the instrument
- > THE MONTH IN RASPBERRY PI 86
Birthday parties and new Pi models galore this month
- > COMMUNITY PROFILE 90
We talk to US teacher Amanda Haughs
- > EVENTS 92
Jams, Dojos, and Clubs around the world next month
- > YOUR LETTERS 94
You ask us things and we answer them

REVIEWS

- > MATRIX VOICE 74
- > MAKE MARK APP 76
- > NES CASE 79

PI SWITCH

32

Create a retro console with Switch controllers



QROCODILE

34

Control your music with QR codes

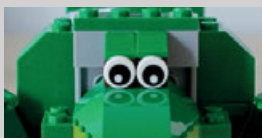

PIXEL

36

A 3D-printed, electromechanical display

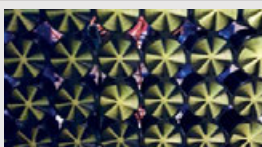



Wes Streeting MP hosted the special Code Club event, organised by Lloyds Banking Group

CODE CLUB IN WESTMINSTER

Showcase event for MPs and Lords “a special experience”



Code Club's Dan Powell talking with some of the pupils from Coppice Primary School

Code Club came to Westminster in January, to demonstrate how a Code Club works to MPs and Peers. The event was organised by Lloyds Banking Group, hosted by Labour MP Wes Streeting, and Code Club was invited to take part.

Coppice Primary School, from Wes's Ilford North constituency,

was invited to “simulate a Code Club in Portcullis House,” says Dan Elwick, Code Club regional coordinator, London & East of England.

Code Club participated “to raise awareness within the Houses of Parliament, as well as to staff in Lloyds Banking Group, about what Code Club is, and how it works,” Dan explains to us.



Pupils appeared to enjoy the pop-up Code Club at Portcullis House in Westminster



“Politicians were coming in during their lunch break,” Dan reveals, “and there was a talk from Lloyds Banking Group and Wes Streeting... I think also it was a special experience for the children involved.”

Hosting the event “over the road from the Houses of Parliament”, as Dan puts it, gave the children of Coppice Primary the chance to “come to Westminster and experience that

are held for children aged 9 to 13 years old – see codeclub.org.uk.

“So we set the children a couple of Code Club projects,” Dan reveals. “There was one fairly basic project, and then another more advanced one. All the guests could see the children coding and how much they enjoyed making things with code.”

The first project was Ghostbusters, “a game where you clone lots of ghosts, and

“ To raise awareness within the Houses of Parliament about what Code Club is

environment.” It also allowed politicians to see a Code Club in action, and talk to children about their coding skills. “Children were so excited to be there and the MPs clearly enjoyed it too,” Dan tells us. “There was a real buzz in the room.”

The event ran for an hour and a half, over a lunchtime. In that time the 28 pupils from Coppice Primary created one of two games, based on Code Club projects.

Playing politics

The children were a “mixed cohort [of] Code Club members and selected pupils from years 4, 5, and 6”, Dan explains. Code Clubs

then ‘click’ to catch them,” says Dan. The second was Clone Wars, a “Space Invaders-style game, where you’re shooting lightning bolts at hippos that are falling from the sky.”

Both projects are on the Code Club Projects webpage (see magpi.cc/unpyFy) and use Scratch.

MPs and Peers from Parliament chatted with the children as they worked on their games. “The children found that really interesting,” Dan confirms. “I heard one of the Lords saying to the children, ‘And that’s why you should all stand for election in your local area when you grow up!’”

CODE CLUB IN LLOYDS BANKS

The event was organised by Lloyds Banking Group, and Code Club was delighted to be asked to take part. As Sarah Sheerman-Chase, Senior Programme Manager, explains, “We’ve been collaborating with Lloyds Banking Group for about 18 months now, and they’re really keen supporters – hundreds of their staff are registered to volunteer with Code Club and their colleagues run over 70 clubs.”

Lloyds Banking Group has its “own, internal drive for digital inclusion, and Code Club is key part of that initiative,” says Sarah. The scheme is called Digital Champions, where over 27 000 colleagues have pledged to help people or charities with their basic digital skills. It’s part of the bank’s Helping Britain Prosper Plan, which Lloyds Banking Group says: “takes us beyond business as usual.”

It tackles the social and economic issues that matter to Britain, such as building digital skills and tackling social disadvantage.

Sarah reveals, “There are around 700 [Lloyds Banking Group] colleagues registered with us now”, while Lloyds Banking Group “has also started a pilot of Code Clubs in some of its branches.”

Gareth Thomas, a Senior Manager at Lloyds, discusses a project with two young coders



OPENAUTO:

ANDROID AUTO RUNNING ON A RASPBERRY PI

Upgrade your car's navigation and entertainment system

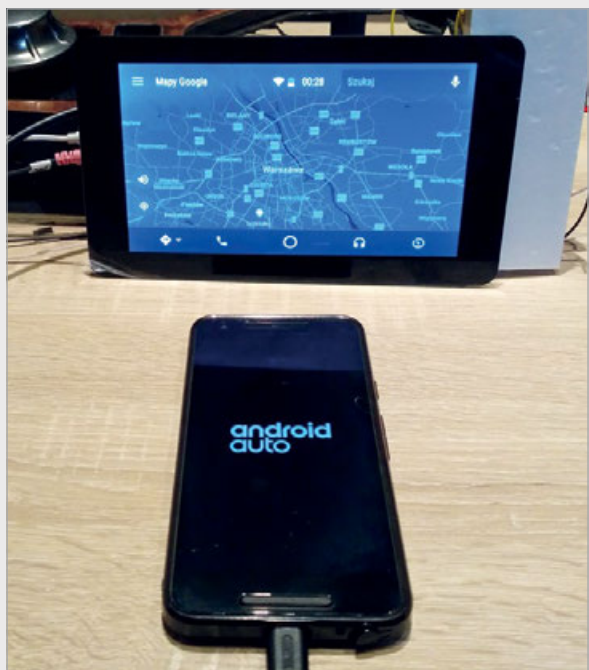

Above OpenAuto is an Android Auto emulator, allowing your Android smartphone to 'project' its interface onto your car's screen

Software engineer Michal Szwaj has released an open-source Android Auto emulator called OpenAuto, which runs on a Raspberry Pi 3.

Michal's motivation for the project was straightforward: he wanted to retrofit his car and use Android Auto while driving. "I wanted to keep my car's original head unit to preserve the design of the dashboard," says Michal, but his car is "14 years old, so its head unit is far, far behind the modern head units."

Thankfully a Raspberry Pi 3 has "a lot of advantages" for OpenAuto, as Michal lists: "It is very cheap, [has a] multicore processor, hardware video decoding, OS based on Linux, support for the MCP2515 CAN Bus module, and RCA video output."

Android Auto essentially allows an Android smartphone to 'project' its interface onto another screen, but while this "sounds trivial," Michal reveals that actually "projection requires processing a huge amount of data" as the projection system needs to display the Android Auto screen, play sounds, and relay user inputs to the smartphone as quickly as possible.

Michal reveals, "The challenge is to handle projection on [a Raspberry Pi], where RAM and CPU utilisation is very limited and even a small bottleneck leads to audio or video glitches."

In-car entertainment

Michal continues, "The most important thing to implement [for successful emulation] was support for hardware acceleration of video decoding."

He tells us, "As far as I know, all Android Auto POCs use GStreamer to render the video stream." Alas, "GStreamer used on the Raspberry Pi does not provide plug-and-play support for OpenMAX," according to Michal's research. This means that OpenAuto's video is "pretty slow, even at 480p@30[fps]."

As such, Michal cannot recommend you install OpenAuto in your car just yet, but by the time you read this, version 1.0 of the software should have been released for you to trial on a bench.

Head to magpi.cc/cbSUyr to see how to install OpenAuto in Raspbian.

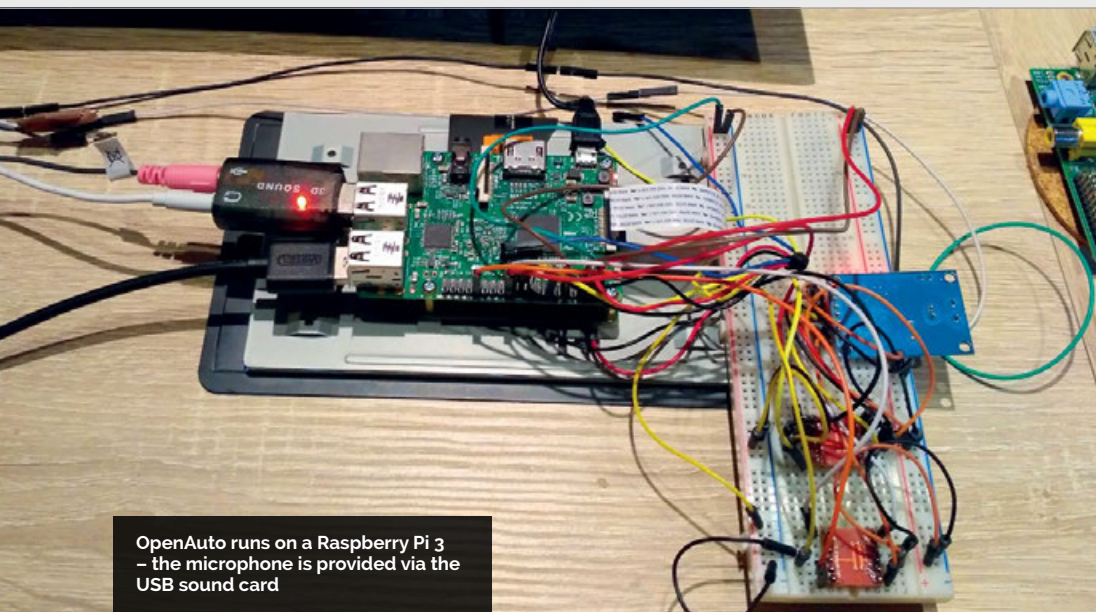

OpenAuto runs on a Raspberry Pi 3 – the microphone is provided via the USB sound card

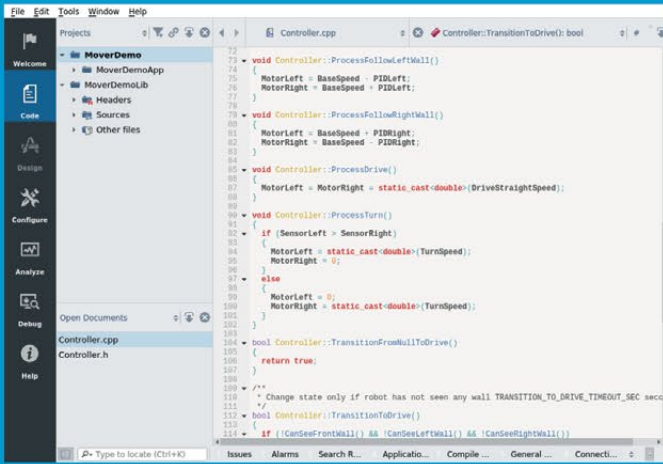

Code

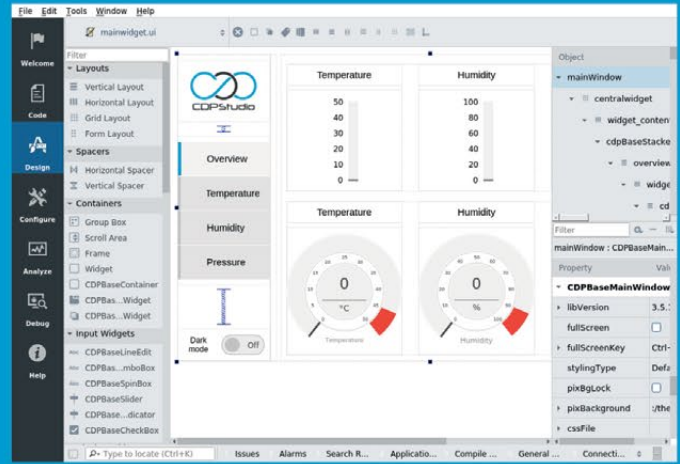

Design

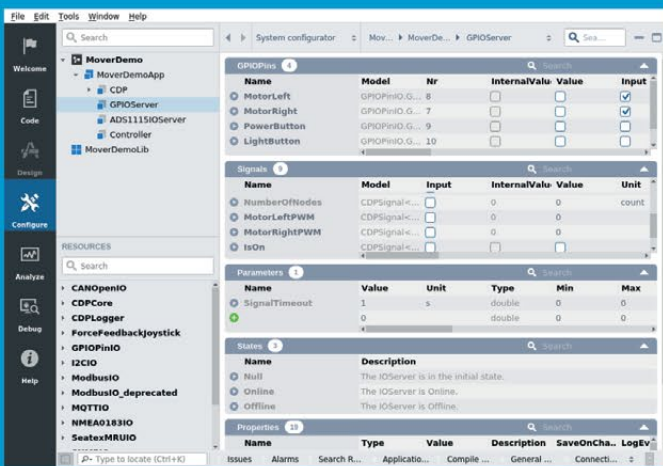

Configure

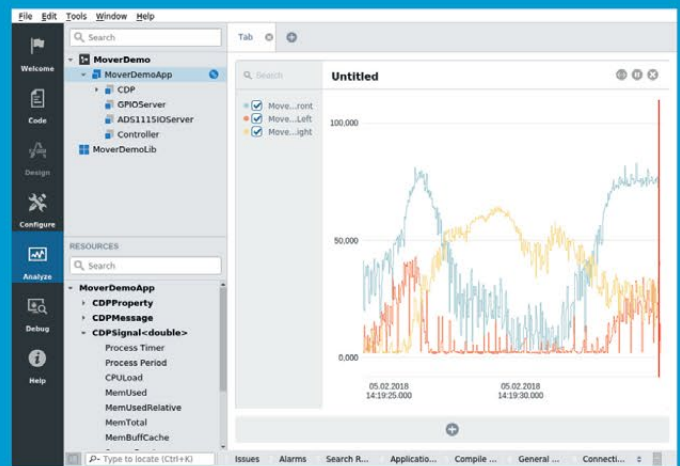

Analyze

Now free for home projects

A professional control system development tool

CDP Studio is a development platform for industrial control systems, now coming with a free version for non-commercial use. The system can run on a Raspberry Pi, supports C++, open source libraries and has a large feature toolbox including GPIO, I2C and MQTT. Its built in GUI design tool and features lets you code less and do more.

Free download on www.cdpstudio.com

CDP Technologies AS
Nedre Strandgate 29
P.O. Box 144
NO-6001 Ålesund, Norway

Tel: +47 990 80 900
info@cdptech.com
www.cdpstudio.com



WINDOWS 10 UP AND RUNNING

Full-fat Windows 10 with your Raspberry Pi

Software engineer Bas Timmer managed to get the full, x86 version of Windows 10 running on a Raspberry Pi 3. But it wasn't easy.

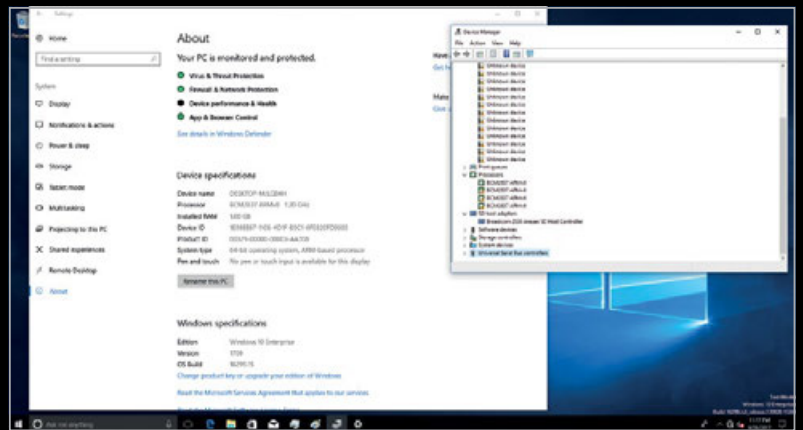
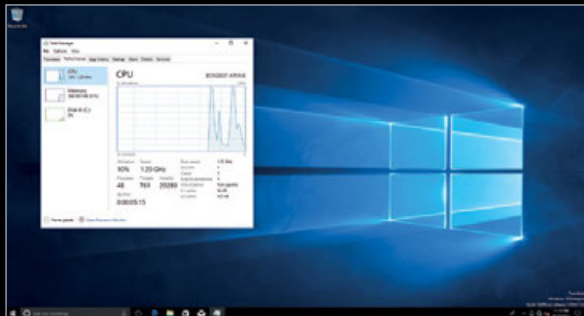

Above Look very closely – that's the Broadcom BCM2837 processor of a Raspberry Pi listed in Windows 10's Device Specifications

Bas tells us that he used both standard versions of Windows, as well as the ARM64 version, to compare codebases. His first attempt, to port the "UEFI version from the IoT Core" to boot into Windows didn't work out.

Instead, Bas "added the required features to run Windows (ACPI tables) to an open-source UEFI I'd found for the RPi on GitHub [see magpi.cc/guhzUy]."

After "some days of debugging", Bas managed to get into the Windows boot/install environment. Unfortunately, the drivers for

nearly everything were missing, so Bas had to write "a hacky driver" just to get a USB keyboard to work.

Curiously, Bas found that Windows 10 has support for "a special interrupt controller" used in the Raspberry Pi's Broadcom processor "that's not usually used in ARM chips."

You can read about Bas's progress, and see new updates, through his Twitter account @NTAuthority.

RASPBERRY FIELDS FOREVER

New Raspberry Pi summer festival launched

This summer sees the first Raspberry Fields 'community celebration', held in the home of the Raspberry Pi – Cambridge, UK.

Held over the weekend of Saturday 30 June and Sunday 1 July, the new annual festival is a celebration of

everything that makers have learnt and achieved since the Raspberry Pi was launched six years ago.

The weekend will include opportunities to learn about the amazing projects that community members are working on, try activities, watch fascinating science and technology talks, and generally celebrate all things Raspberry Pi and digital making.

There will also be face-painting, fun performances, free giveaways, delicious food, and other festival-themed activities to get involved with.

The festival will be led by the Raspberry Pi Foundation, but run by



its volunteer community of young people, hobbyists, educators, and enthusiasts of any age and skill.

Tickets cost £5 for over-16s and are free for under-16s, bought from the Cambridge Junction site before arriving. Head over to raspberrypi.org/raspberry-fields for more information.

Above The first Raspberry Pi festival is happening this summer, on Saturday 30 June and Sunday 1 July





RASPAD TABLET

Simple as an iPad; flexible as a Raspberry Pi

Chinese company SunFounder has smashed its Kickstarter campaign for its RasPad, a 10.1-inch tablet PC based on the Raspberry Pi.

With an initial target of just £7246, the RasPad raised around £22 000 in its first hour and, at the time of writing, was up to over £250 000 – see magpi.cc/huCotU.

It's easy to see why, with an IPS touchscreen and a 'Hatch' at the rear for access to the GPIO pins and camera connector. You can even use RasPad's screen as a secondary display via its dedicated inputs. Prices start at just \$129 (£95).

Mike Wong, CEO of SunFounder, wanted to use the Raspberry Pi because "[its] community is one of the largest, offering lots of useful information and open-source resources."

The access to the GPIO pins was "a necessity" in Mike's view, given how people "buy Raspberry Pi to learn hardware programming."

Mike confirms, "We wanted an all-in-one tablet that's also useful for DIYers... We just want the RasPad to serve as a vehicle to see where people's creativity can really take them."



Right The IPS screen offers iPad-style visuals with Raspberry Pi levels of hacking and making

NOW TRENDING

The stories we shared that flew around the world



HOLOGRAM NOVA REVIEW

magpi.cc/cqetsf

Adding a cellular modem to your Raspberry Pi has never been easier – just plug the Nova into one of the Pi's USB ports, install the software, and you've got yourself an IoT device ready to monitor the world.



THE NEXT VERSE AT THE V&A MUSEUM

magpi.cc/kDoAvk

Artist Stewart Francis Easton created an artwork that combined embroidery, music, and a Raspberry Pi 2 to depict the cycle of life. Elements of the image were embroidered using conductive thread, making them interactive.

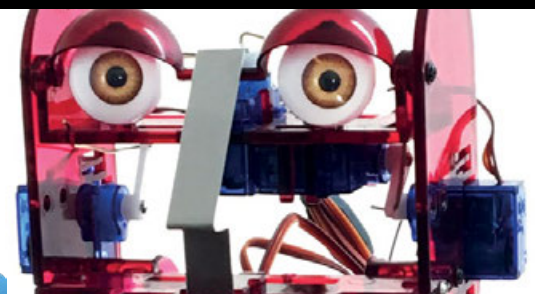

OHBOT PI REVIEW - ROBOTIC FACE

magpi.cc/rwPUCM

You can now control this robotic face with your Raspberry Pi, with a wide range of actions available, from head turns to blinking eyes to lip movement. The sense of creepiness fades pretty quickly.

RASPBERRY BOOM

Detect aurorae, heavy traffic, or meteors on your Raspberry Pi

From the makers of the Raspberry Shake – a seismograph for your Pi – comes the Raspberry Boom, a device to detect ‘infrasonic’ noises undetectable by the human ear.

While the Shake detects movements, the Boom detects noises, so it can discern just about any event, from avalanches and breaking icebergs to lightning and transport.

The sensor detects sound waves of 0.05–20 Hz, way below typical human hearing. But Mike Hotchkiss, consumer marketing manager for Raspberry Shake, confirms that “the Raspberry Boom was designed to be operated in your home” – the

device and software will filter background noises.

You can connect your Raspberry Boom device to the Station View network of sensors. Mike also clarifies, “We have a few ways for users to grab the data in real-time and integrate into their own websites,” Full details are at magpi.cc/jJBvsM.

The Raspberry Boom is being launched via Kickstarter, so head to magpi.cc/cadepc for pricing and more information.

Right The Raspberry Boom detects extremely low-pitched noises, allowing you to detect almost anything

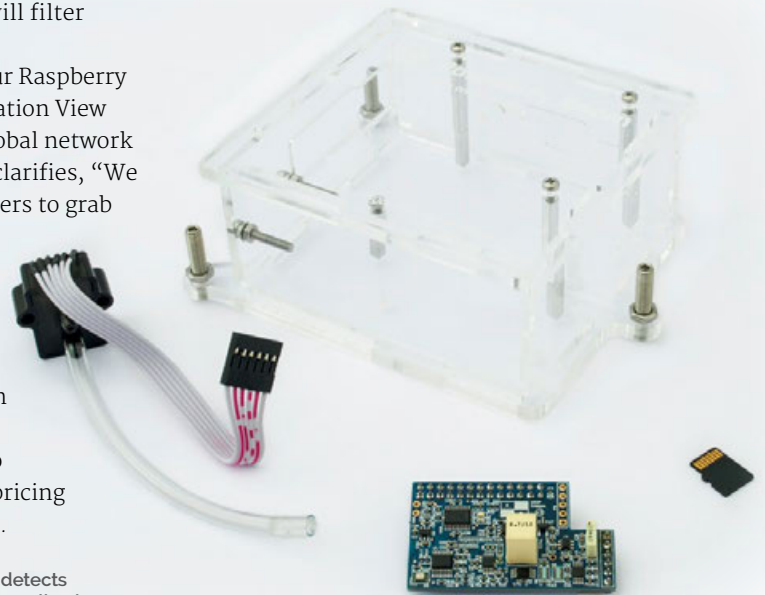

FARNELL LAUNCHES CLOUDIO

IoT meets app-like simplicity

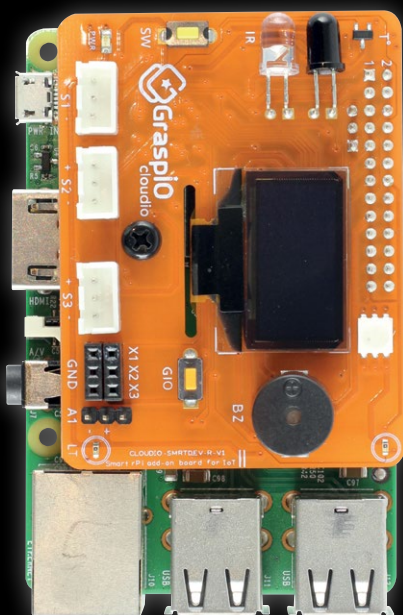

GraspIO’s Cloudio add-on board has a huge range of hardware and sensors to make your first steps into IoT a breeze. It’s even programmed with a drag-and-drop (Scratch-like) interface, so you can set up your device from your phone.

With voice, IR, light, and temperature sensors built in, you’ve got plenty of IoT abilities baked in to the Cloudio board, including a 0.96-inch OLED display. But there are also three ADC ports, a mini servo-motor port, and three digital output ports to incorporate extra abilities.

The app also supports IFTTT integration, a sensor



monitor, dashboard, and custom notifications.

Hari Kalyanaraman, Farnell’s global head of emerging business, tells us, “GraspIO Cloudio is aiming to make things simple for those people with little or no coding experience to create applications... The goal was to make it easy for anyone to build IoT projects and get up and running in minutes.”

The Cloudio board costs £33 from magpi.cc/XbqhhF, and is compatible with all versions of the Raspberry Pi.

Above GraspIO’s Cloudio makes it simple to build and program a sophisticated IoT device in minutes

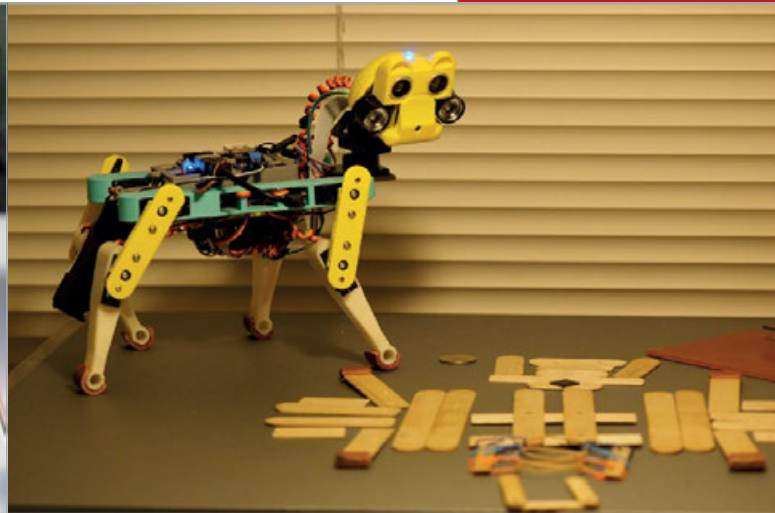
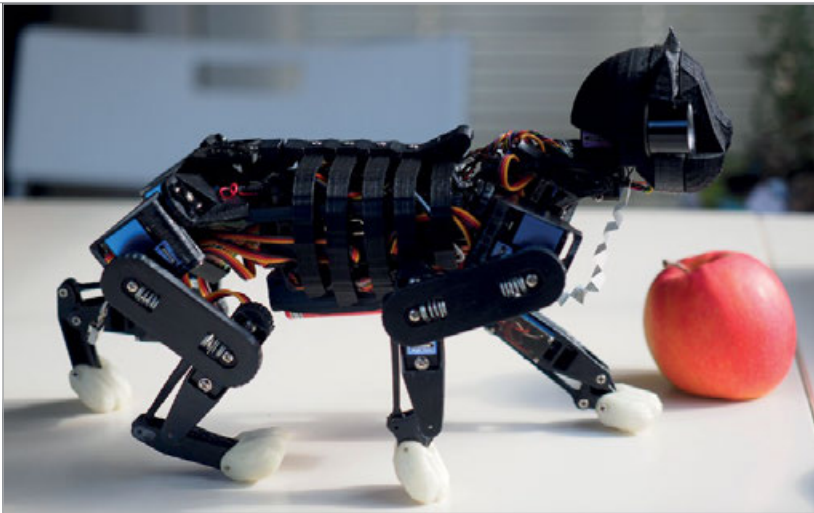

RASPBERY PI ROBO-CAT

Above left OpenCat uses an Arduino to handle the robotics, and a Raspberry Pi to provide higher functions such as Alexa support

Above An early iteration of OpenCat, using modelling sticks to make the body

OpenCat pounces to replace man's best friend

Chinese roboticist Rongzhong Li has created a robotic cat from scratch, including realistic movements and Alexa integration.

Rongzhong started with some modelling sticks and a Raspberry Pi beginner kit, all of which is “still integrated somewhere on the cat,” he tells us. You can see OpenCat’s evolution at magpi.cc/ZWYGKy. The maker wanted to use a Raspberry Pi to power OpenCat because of the “easy access to hardware interfaces under a Linux environment” rather than the Pi being “a tiny and cheap computer.”

Gaited development

Rongzhong studied many mammalian gaits, and believes “different gaits can be generated by simple tuning amplitude, phase duration, and other tiny parameters”. OpenCat is “not constrained by [being a] cat.”

He found that he had to use an Arduino ‘slave’ to handle the robotics, while the Raspberry Pi handles higher functions such as the Alexa integration.

Currently, OpenCat uses Alexa “to trigger certain behaviours,” but there are also references to ‘hosting video streams’ through OpenCat. As Rongzhong says, voice assistants “can now run on a pet-like body, and interact with people in a pet-like manner. [This] may encourage more people to embrace robotics at home.”

Rongzhong is currently developing ways to make OpenCat financially self-supporting – whether that means selling OpenCat kits or something else, we’ll have to wait and see.



GoPiGo

20+ new projects for your Pi robot car.



BrickPi3

LEGO MINDSTORMS + RASPBERY PI



www.dexterindustries.com

pi-top

Inspiring inventors and creators to seek the skills of tomorrow and create their future, today.



OCR
Oxford Cambridge and RSA



The modular laptop with sliding keyboard

- 8HR BATTERY LIFE
- 14" FULL HD 1080P SCREEN
- 180° HINGE
- CUSTOM PASSIVE COOLING BRIDGE
- MODULAR RAIL

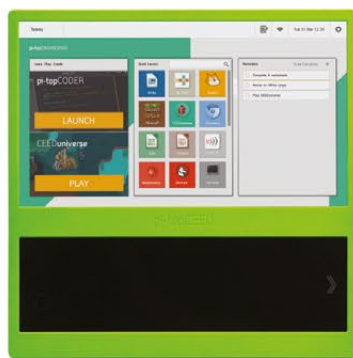

The modular desktop

- 14" FULL HD 1080P SCREEN
- MODULAR RAIL
- ADJUSTABLE VIEWING ANGLES



pi-topPROTO



pi-topSPEAKER



pi-topPULSE

pi-top

Colors 
Raspberry Pi 3 optional

AWESOME INVENTOR'S KIT INCLUDED

20+

 projects to explore

Explore beyond the screen and keyboard by creating with the all-new **pi-top** modular laptop.

Get started with 20+ inventions in the inventor's guide booklet. There are 3 inventor's journeys - Smart Robot, Music Maker and Space Race.

pi-topCEED

Colors 
Raspberry Pi 3 optional

pi-topCEED is the plug & play modular desktop. It's the easiest way to use your Raspberry Pi. We've put what you love about our flagship laptop in a slimmer form factor. Join hundreds of code clubs and classrooms using **pi-topCEED** as their solution to Computer Science and STEAM-based learning.

Modular Accessories



pi-top is an award-winning ecosystem designed to make experimenting, coding and building electronics, simple, affordable and fun. **pi-topOS** is here to guide you through the world of making!

The OCR* endorsed **pi-topOS** (Operating system) platform comes pre-installed on the SD card shipped with every unit. **pi-topOS** software suite lets you - browse the web, - check emails, - create and edit Microsoft Office compatible files. Gain access to dozens of hands-on learning lesson plans with **pi-topCODER** and have fun learning to code with **CEEDuniverse**!

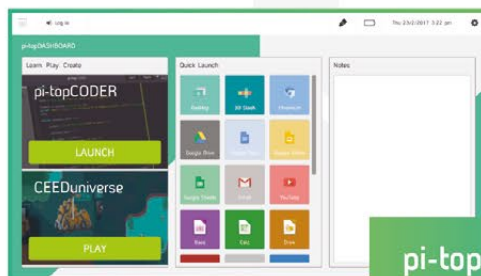

pi-topOS

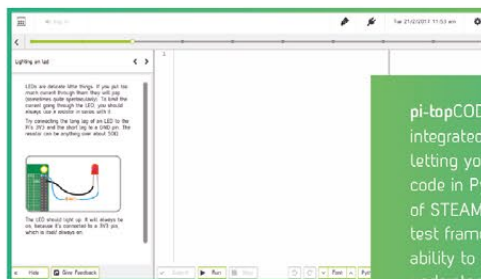

pi-topCODER has a fully integrated coding environment letting you program hardware, code in Python and learn lots of STEAM skills! Our integrated test framework gives you the ability to assess your own understanding as you learn.



CEEDuniverse
Learn programming concepts through our minigames, for example, learn problem decomposition by solving visual programming puzzles.



RASPBERRY PI 3B+

The newest Raspberry Pi is here!



The concept of ‘plussing’ is common at the Walt Disney Company. It was a term coined by Walt himself; the act of looking at an idea or project in development and wondering how they could make it better still. It’s what helps make the ‘Disney Difference’.

Raspberry Pi has taken the original Pi 3 and plussed it to make it better still, in the form of the new Raspberry Pi 3 Model B+ (or Pi 3B+ for short). Taking the design and features to their logical conclusion in terms of power and speed, the new Pi 3B+ is the ultimate Raspberry Pi so far.

Join us as we explore the most magical computer on Earth.



Places to Buy

UK



The Pi Hut
magpi.cc/zVTpyC



Forthings.io
magpi.cc/KYJbMi



Pimoroni
magpi.cc/LhuKdS



CPC
magpi.cc/aIgcOF



Pi Supply
magpi.cc/LkTVfU



ModMyPi
magpi.cc/rMXCsW



RS Components
magpi.cc/nDkZGZ

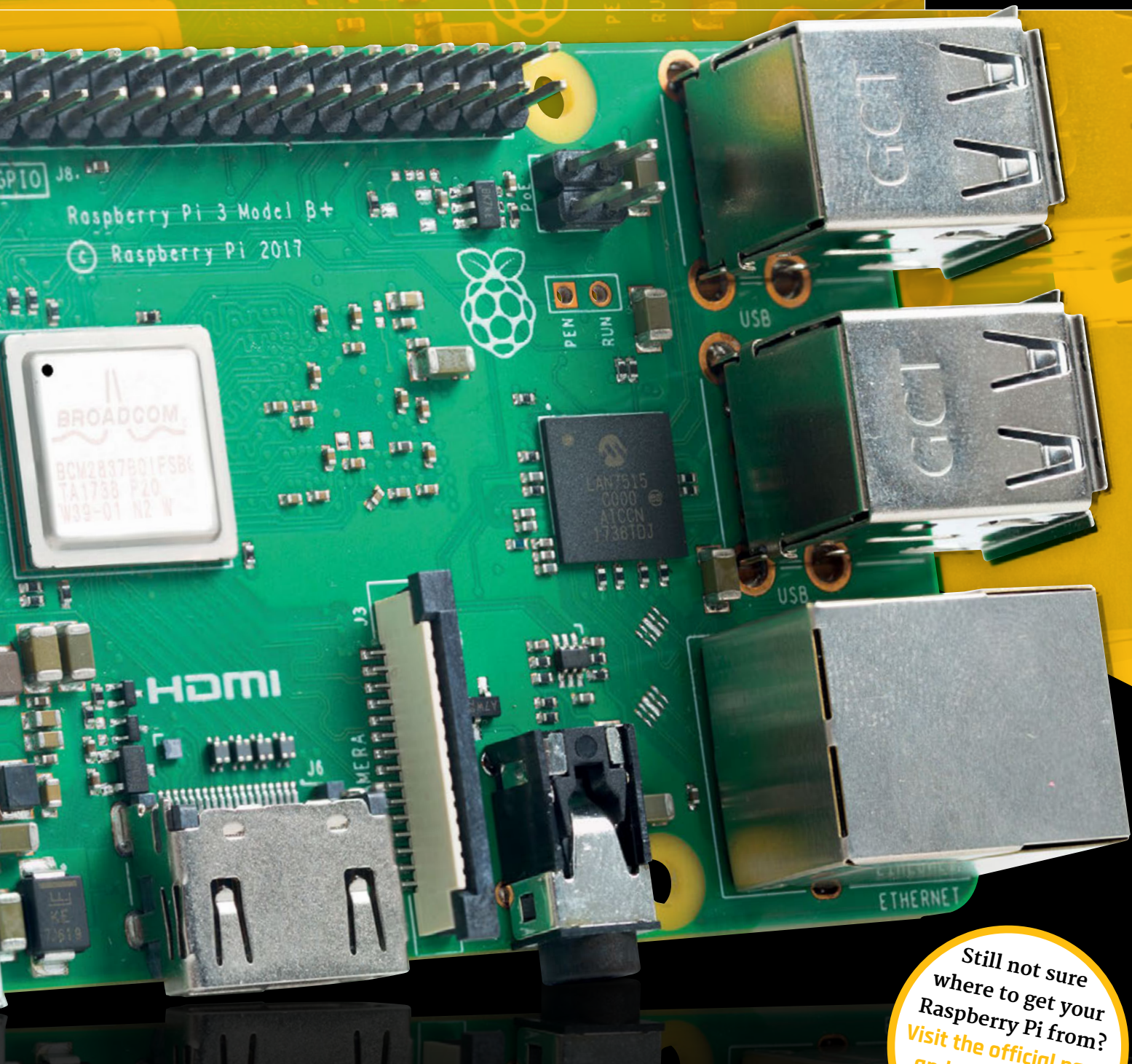

Still not sure where to get your Raspberry Pi from? Visit the official page and click Buy Now! magpi.cc/p0yjBN

North America

 **Adafruit**
magpi.cc/zmwrgr

 **Allied Electronics**
magpi.cc/oYjmQJ

 **Micro Center**
magpi.cc/ilGneE

 **element14**
magpi.cc/MwMCFy

 **PiShop.us**
magpi.cc/OXUfGh

 **CanaKit**
magpi.cc/CfUyzz

Europe

 **Yadom**
magpi.cc/rkxwtO

 **pi3g**
magpi.cc/kyZutY

 **Reichelt**
magpi.cc/bvezBQ

 **Rasppishop**
magpi.cc/XCZMOC

 **Kubii**
magpi.cc/NliAVB

 **Kiwi Electronics**
magpi.cc/QraRma



MEET THE RASPBERRY PI 3B+

A plus in the name hides a wealth of new hardware and design tweaks in a classic footprint

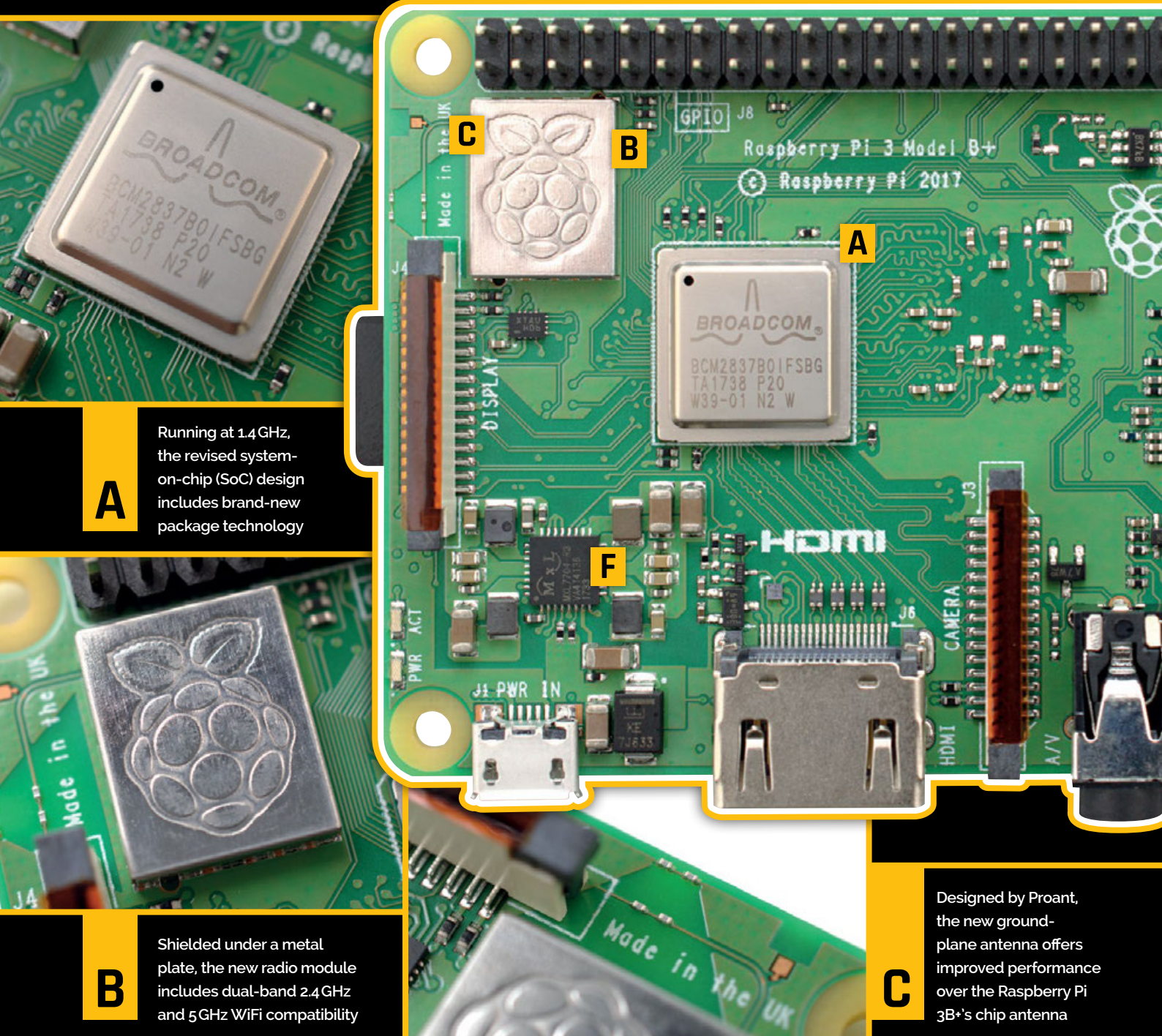

A Running at 1.4 GHz, the revised system-on-chip (SoC) design includes brand-new package technology

B Shielded under a metal plate, the new radio module includes dual-band 2.4 GHz and 5 GHz WiFi compatibility

C Designed by Proant, the new ground-plane antenna offers improved performance over the Raspberry Pi 3B+'s chip antenna

Specifications

SoC:
Broadcom BCM2837B0
quad-core A53 (ARMv8)
64-bit @ 1.4 GHz

GPU:
Broadcom VideoCore IV

Networking:
Gigabit Ethernet, 2.4 GHz and
5 GHz 802.11b/g/n/ac WiFi

RAM:
1GB LPDDR2 SDRAM

Bluetooth:
Bluetooth 4.2, Bluetooth Low
Energy (BLE)

GPIO:
40-pin GPIO header, populated

Storage: microSD

Ports:
HDMI, 3.5mm analogue
audio-video jack, 4× USB
2.0, Ethernet, Camera Serial
Interface (CSI), Display Serial
Interface (DSI)

Dimensions:
82 mm x 56 mm x 19.5 mm

Weight: 50 g

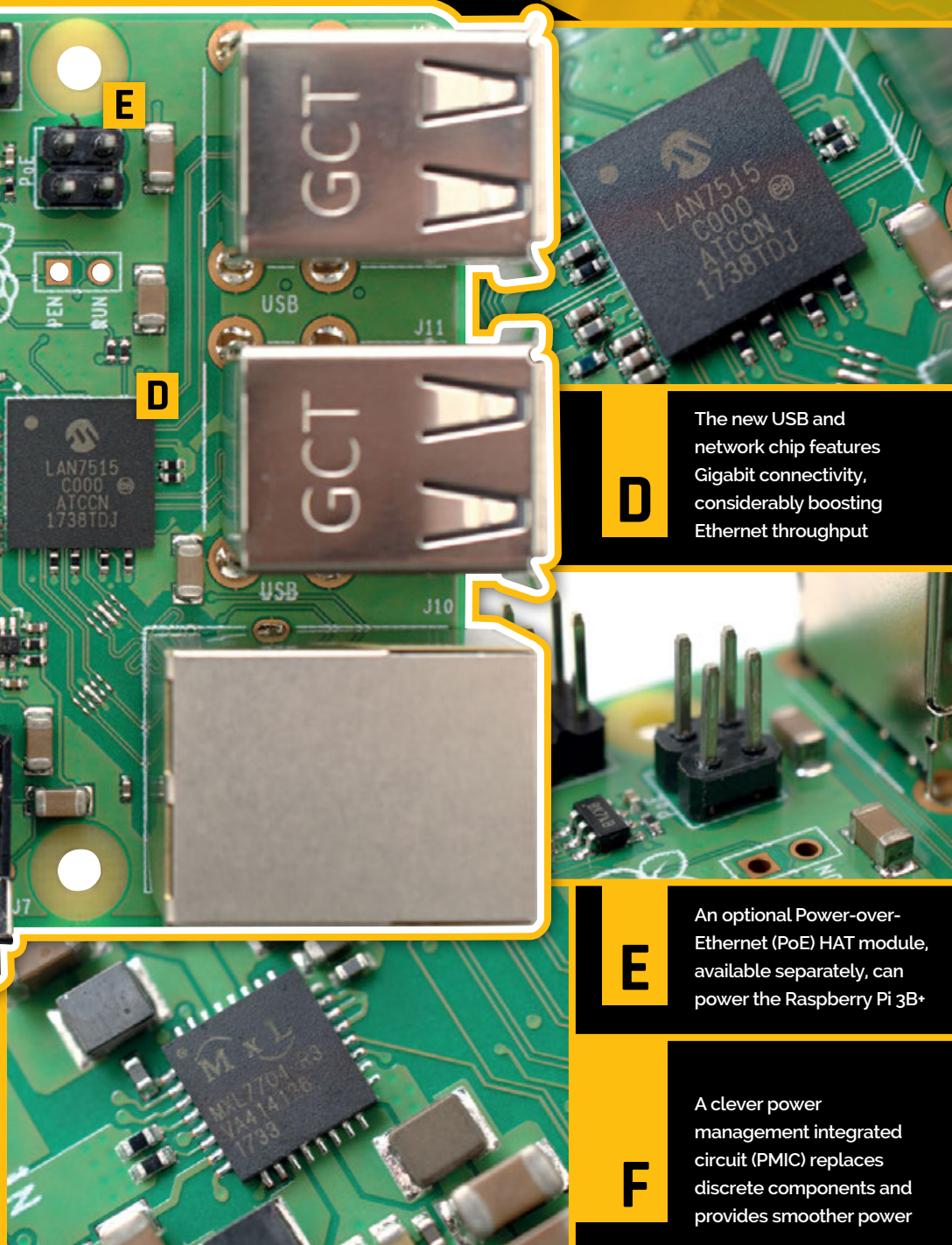

D The new USB and network chip features Gigabit connectivity, considerably boosting Ethernet throughput

E An optional Power-over-Ethernet (PoE) HAT module, available separately, can power the Raspberry Pi 3B+

F A clever power management integrated circuit (PMIC) replaces discrete components and provides smoother power

QUICK SETUP



>STEP-01
Download an operating system
You'll need an operating system, available from raspberrypi.org/downloads, to use your new Raspberry Pi. Raspbian, the Foundation's official operating system, is the best choice for most users.

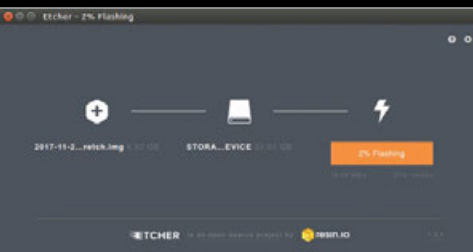

>STEP-02
Flash to microSD card
Install the operating system – a process known as 'flashing' – onto a high-quality microSD card of at least 8GB (Raspbian Lite) or 16GB (Raspbian with Desktop). The easiest way is to use the tool from etcher.io and follow its three steps.



>STEP-03
Connect the cables
Insert the microSD card, then begin connecting cables. For most users these will include an HDMI display, a USB keyboard and mouse (or Bluetooth receiver for them), an Ethernet cable (optional), and finally a 2A or higher 5V micro-USB power supply.



BENCHMARKING THE PI 3B+

The promise of improved performance is one thing, but there's only one way to get to the truth of the matter: benchmark testing

With an upgraded processor boasting impressive new packaging and improved networking capabilities, the Raspberry Pi 3B+ should sit head and shoulders above its predecessor the Raspberry Pi 3. To determine whether these improvements are noticeable in the real world, the Pi 3B+, along with the Pi 3 and a range of other board models, have been put through a series of benchmark

tests, measuring everything from raw CPU performance to power draw and WiFi signal quality.

Spec comparison

Although it's the same underlying design as on the Pi 3, the Pi 3B+'s BCM2837 system-on-chip (SoC) is now in spin B0 and features improved packaging alongside a heat-spreader, which have helped boost its performance from 1.2 GHz to 1.4 GHz. This has

a knock-on effect on memory performance, too, while the new USB Ethernet controller offers Gigabit connectivity at a theoretical maximum throughput of 300 Mbps, due to its use of a single USB 2.0 channel. Finally, a switch to a new dual-band radio module and antenna design inspired by the Pi Zero W improves the Pi 3B+'s connectivity compared to its predecessor.

PYTHON GPIO

Higher is better

Driving the GPIO pins via Python can result in a CPU bottleneck, as demonstrated by this simplest of programs: a pin is switched on and off as quickly as possible while connected to a frequency counter. Note that updates to the GPIO driver and Python itself will alter these results.

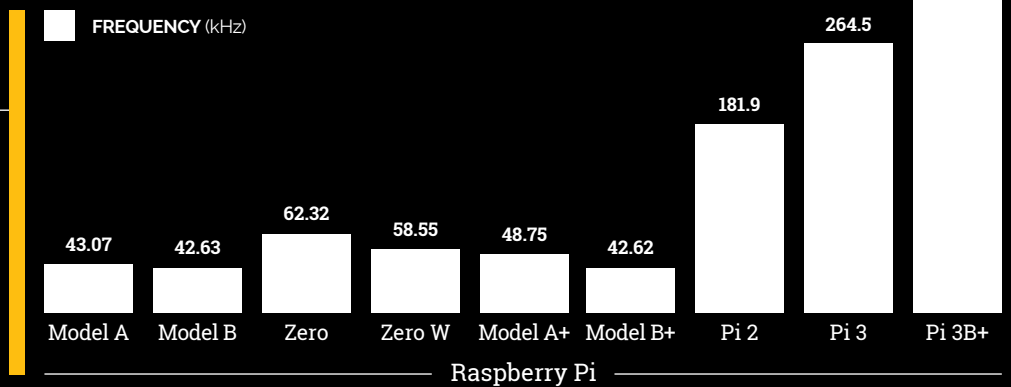

SYSBENCH CPU

Lower is better

A synthetic benchmark designed to stress the central processor, SysBench's CPU test highlights the performance gains available to CPU-bound applications – in particular those which can take advantage of the multiple processing cores available on the Pi 2, Pi 3, and Pi 3B+.

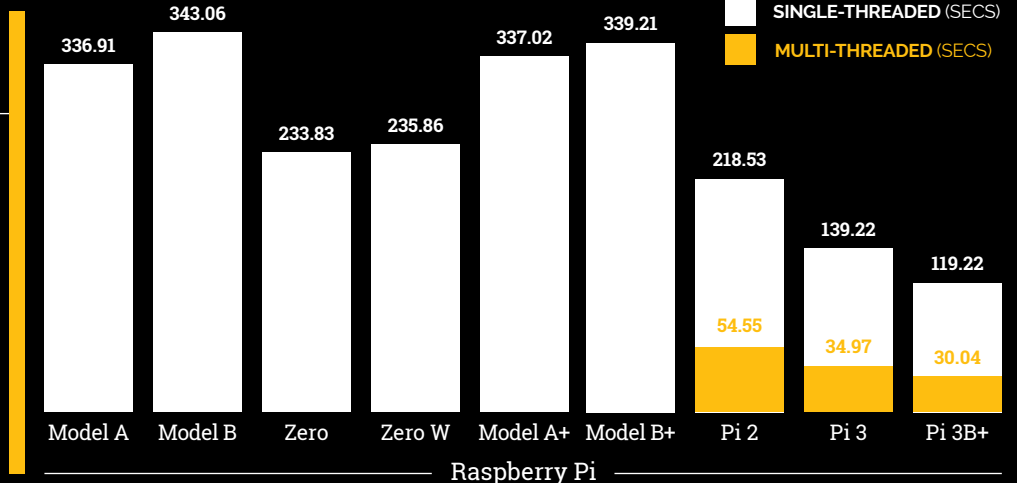

SYSBENCH MEMORY THROUGHPUT

Higher is better

Not all applications are limited by available CPU performance, with some reliant on memory throughput – the speed at which data can be written to and read from RAM. The SysBench memory test carries out repeated 1kB reads and writes then reports the throughput in megabytes per second (MBps).

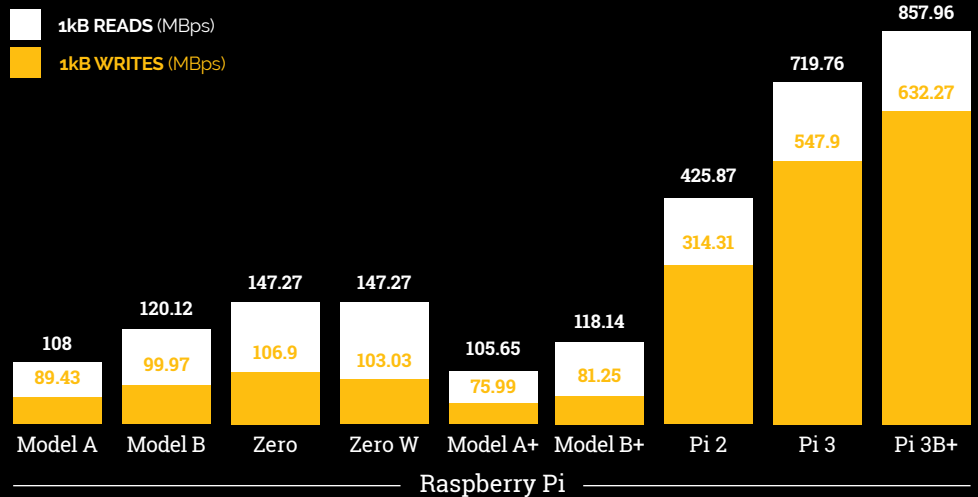

ETHERNET THROUGHPUT

Higher is better

The Ethernet port, which connects via a shared USB channel, has been the last feature of the Raspberry Pi design to receive an upgrade. This test copies an incompressible 100MB file to each Pi on test, and there's no surprise in seeing the Pi 3B+'s Gigabit Ethernet topping the chart.

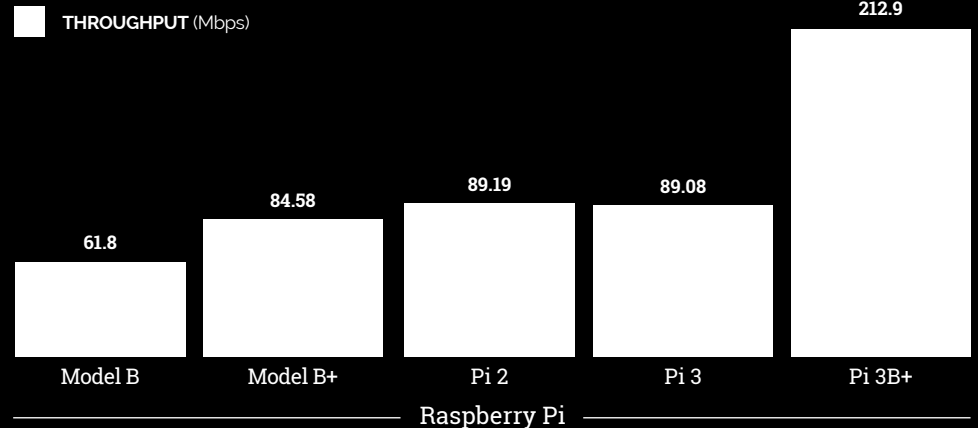

WIFI SIGNAL QUALITY

Higher is better

A head-to-head shoot-out between the Pi 3's single-band 2.4GHz WiFi radio and chip antenna and the Pi 3B+'s new dual-band 2.4GHz and 5GHz radio with ground-plane antenna offers a look at the improvements you can expect in both signal quality and number of visible access points.

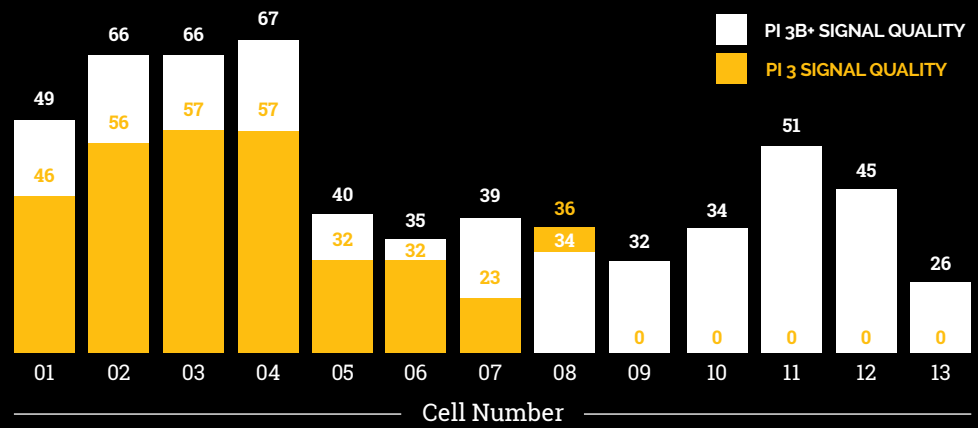

POWER DRAW

Lower is better

More performance is always welcome, but there's no such thing as a free lunch. This test, which measures power draw at the desktop with an HDMI display, wireless keyboard, and – where applicable – Ethernet connected, shows how an older model of Pi may be better suited to battery-powered and embedded applications.

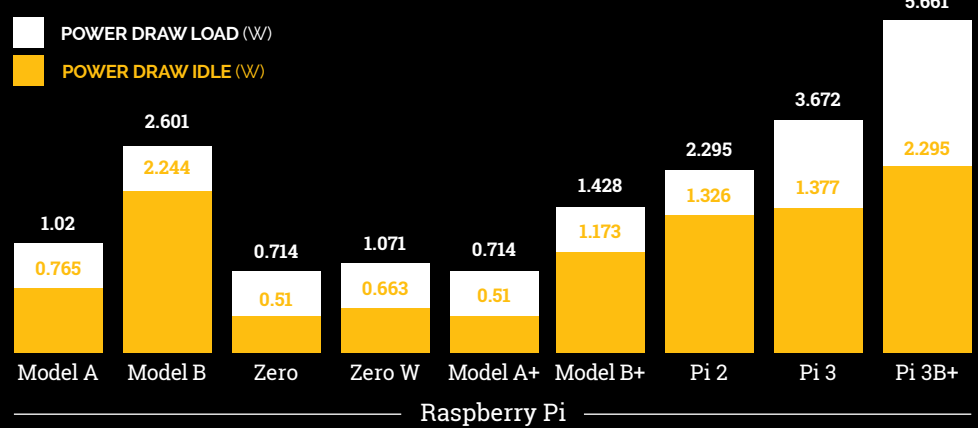



UPDATING THE RASPBERRY PI

Eben Upton, co-creator of the Raspberry Pi and co-founder of the Raspberry Pi Foundation, delves into the technology that makes the new Pi 3B+ special



"If you sit still and think about it, it just doesn't seem real," says Eben Upton regarding the Raspberry Pi's success

When working on a new Raspberry Pi design, there's one thing Eben Upton always keeps clear in his mind. "It's a Raspberry Pi, so it costs \$35," he laughs. Delivering constant improvements without increasing the price is a challenge, but one the Raspberry Pi Foundation welcomes. "Over time, there are a couple of things that help," Eben explains. "One is obviously a Moore's Law thing [the observation by Intel co-founder Gordon Moore that the number of transistors on a new chip doubles every 18 months], where you can genuinely get more silicon for your money. That particularly applies to RAM: DRAM [dynamic random access memory] has gone

through probably four or five process shrinks between Pi 1 and Pi 3B+. I don't think we're spending significantly more on RAM now, despite having quadrupled the amount of RAM in the device. "The other thing is a gradual increase in the amount of silicon we can put in the design. More and more of the BOM (the bill of materials) is silicon, and the reason for that is that the cost of manufacturing Raspberry Pi keeps going down because of automation. There are still investments going on in automation now that are taking costs down. The other thing is connectors: I pay a lot less for an HDMI connector than I used to, and that's just economies of scale."

Looking Back

"We just didn't see the Raspberry Pi's success coming," admits Eben. "It's still very strange to be where we are now. It's great, you know, the Foundation's got 80-something people working for it; across the two organisations, Foundation and Trading, we've got 120 people, and are on our way to 150. Hundreds of thousands of kids attending Code Clubs, and all the teachers we've trained."

"It's amazing. It's a weird journey, such a weird journey, that still doesn't really seem real. If you sit still and think about it, it just doesn't seem real. But it's been great!"

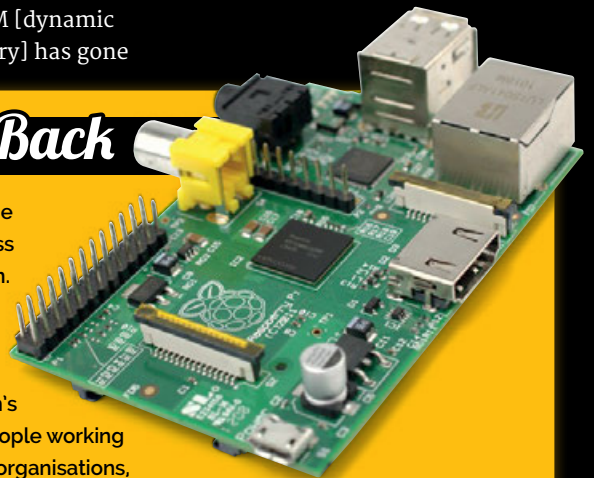

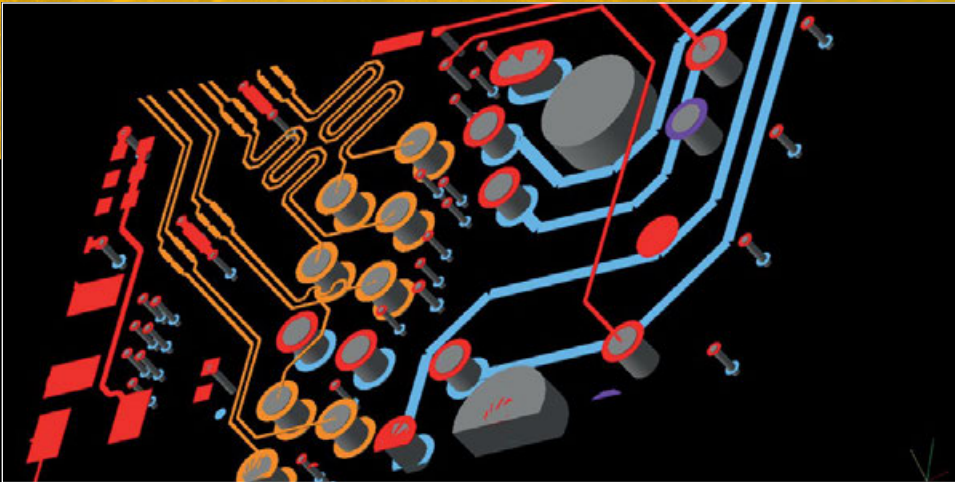

The Pi 3B+ offers boosted performance, some of which is explained by the new packaging technology, but not all. “While most of the frequency uplift comes from the changes we made to the Broadcom part, the new Power

WiFi is hard to do,” reveals Eben. “The reference PCB layouts assume a higher level of PCB technology than we have. You can’t just get the reference PCB design and use it, because it’s not on the right PCB technology, so getting a PCB

Above A 3D rendering highlights the ‘vias’ that connect layers of the Pi 3B+ circuit board

Packaging Performance

“The BCM2837B0 is largely the same chip as before, but it’s a higher-tech package,” explains Eben. “We’ve made various tweaks to the package design which have the effect of reducing both the resistance between the [solder] balls and the transistor which is furthest away.

“We’ve also experienced challenges in the past associated with the distance between the thermal sensor on the die and the thing that’s generating all the heat. The new metal heat-spreader has the effect of ensuring that the entire die sits at the same temperature. It also gives you a somewhat larger area to do convective, conductive, radiative heat loss from.”

“ The cost of manufacturing Raspberry Pi keeps going down because of automation ”

Management Integrated Circuit is quite a substantial contributor to it, by reducing the extent to which we need to margin for the regulation accuracy and load-step.”

The overhauled networking was trickier to implement. “5 GHz

design that was implementable and still had the requisite signal integrity and stuff required to do conformant 5 GHz was really fiddly and required a bunch of iteration.

OLD TECH

The original Pi 3 isn’t going away, though. “It’ll be sold alongside it,” explains Eben. “I expect the 3B+ will replace it for most consumers, there’s not much reason to buy a Pi 3 if you have a Pi 3B+, but for industrial use it’s a bit different because you’ve got people who have designed the Pi 3 into stuff.

“We’re always surprised by the long tail of old products. You know, we still sell the Raspberry Pi 2. I don’t know, we probably sold 100 000 Raspberry Pi 2s last year, something like that, so there’s always that long tail, and I think that tail is going to be longer and thicker for the Pi 3 than it’s been for any previous product.”



Above Roger Thornton designed the Raspberry Pi 3B+ board, having previously worked on the Pi Zero W

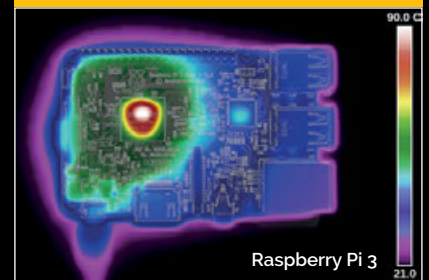
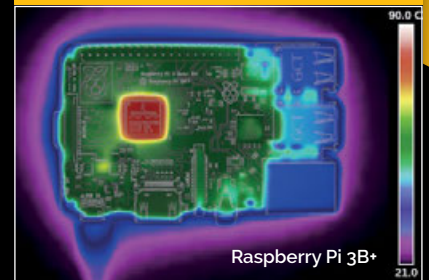

Below Conformance testing for 5 GHz WiFi was a challenge for the new radio hardware



GET STARTED WITH YOUR RASPBERRY PI 3B+

Is the 3B+ your first Raspberry Pi? Here's what you need to know...

Everyone's got to start somewhere, and if you've ever seen the rate Pi boards are sold we'd hazard a guess that the 3B+ will be someone's first Raspberry Pi. If so, welcome to the community! We've got some great tips on where to start on your grand Raspberry Pi adventure.

More on setting up your Pi

Need a bit more info on how to set up your first Raspberry Pi? Head to the official setup guide for a detailed, and easy-to-understand, breakdown: magpi.cc/getstarted.



Connecting to WiFi

Plugging in an Ethernet cable is easy and the only problem you'll tend to encounter is not having a long enough cable, in which case you'll have to connect using the Raspberry Pi's built-in wireless capabilities. This is very easy in Raspbian – simply look in the top right-hand corner for the wireless symbol...

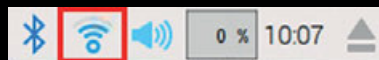
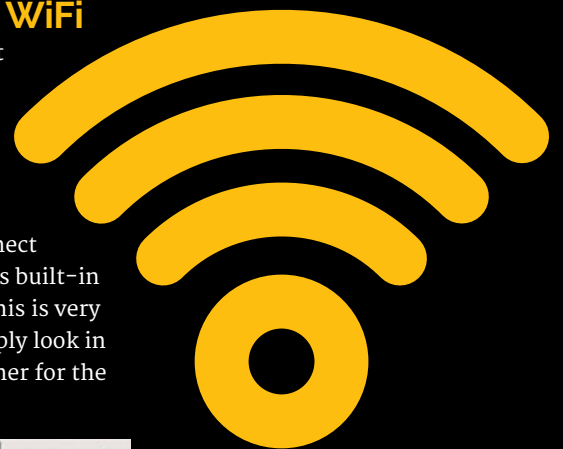

Click on it and select your WiFi name. It will ask for your password and then automatically connect from now on!

Change your password

It's a good idea to change the default password on Raspbian. It's **raspberry** just so you know. As all Raspberry Pis come with a standard password for the standard user name (**pi**), it means other people can more easily access any secret or sensitive files on your Raspberry Pi.

Changing the password is very easy, though. Go to the

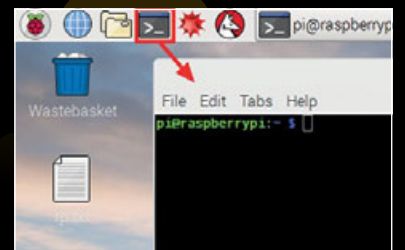

Terminal and then type **passwd** and hit **ENTER**. Enter the current password (**raspberry**) and then enter your new password. That's it!

You can also add a new user name to use instead of the default one if you wish. Check out the full guide on the Raspberry Pi website: magpi.cc/WlunZG.



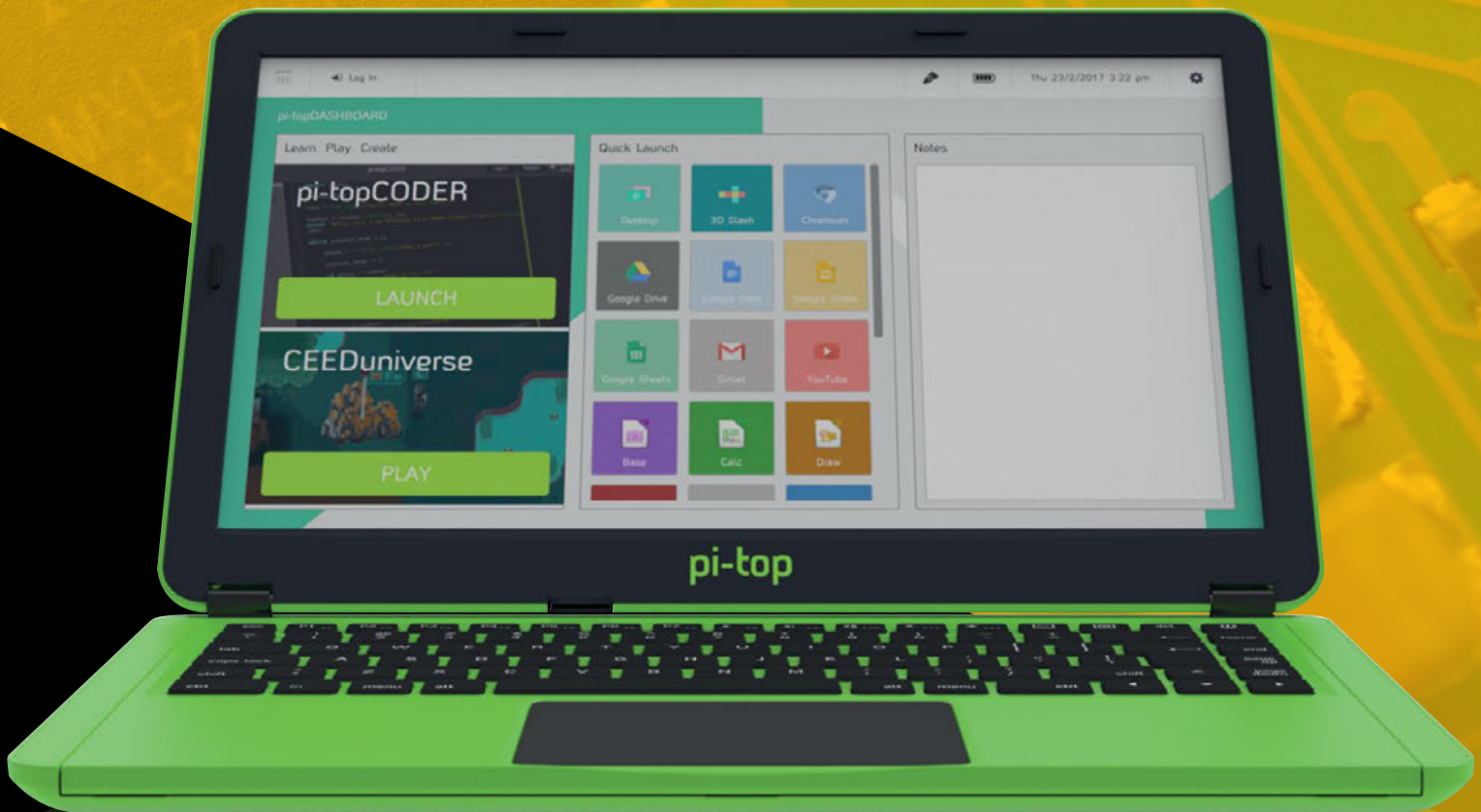

Turn on SSH

In a few tutorials you'll find for your Raspberry Pi online, they'll ask you to do the majority of the work in the Terminal. You can either do this on the Pi, or by controlling it remotely from another computer via SSH.

SSH is turned off by default on the Raspberry Pi, but it can be turned on a couple of ways. Once you've set up your Raspberry Pi, go to Raspberry Pi Configuration in the Menu under Preferences. Go to the

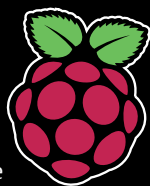

Interfaces tab and click Enable next to SSH. After a reboot, you'll be able to connect to your Raspberry Pi via SSH – on Windows you can use software called PuTTY (magpi.cc/xOaGBD). You'll just need to enter `pi@raspberrypi` as the host name and click Open.

You can also drop an empty file named `ssh` into the boot partition of the Raspbian microSD card to enable SSH automatically. Note: unless you have connected the Raspberry Pi to a wireless network, you'll need a wired Ethernet connection to SSH in to it.

```

pi@mediaserver ~
└─$ ssh pi@mediaserver
Using username "pi".
pi@mediaserver's password:
The programs included with the Debian GNU/Linux system are free software;
the exact distribution terms for each program are described in the
individual files in /usr/share/doc/*/copyright.

Debian GNU/Linux comes with ABSOLUTELY NO WARRANTY, to the extent
permitted by applicable law.
Last login: Fri Mar 16 08:57:50 2018 from roba-laptop.home

SSH is enabled and the default password for the 'pi' user has not been changed.
This is a security risk - please login as the 'pi' user and type 'passwd' to set a new password.

pi@mediaserver:~$
    
```

Upgrading a Pi-top

Your pi-top laptop is very easy to upgrade thanks to the ability to access the Raspberry Pi readily after you've constructed it – just slip the cover off and it's right there!

For the newer version of the pi-top, you'll need to remove the board covering the Raspberry Pi.

Check out the pi-top website (pi-top.com) as well and look for the latest version of the OS to make sure it will all work when connected up.

READ THE MAGPI 65

Everything a total newcomer needs to know is found in issue 65, available as a free download.

➤ magpi.cc/65



TEN PROJECTS TO POWER UP!

Here are some projects that can be made better with a Pi 3B+!

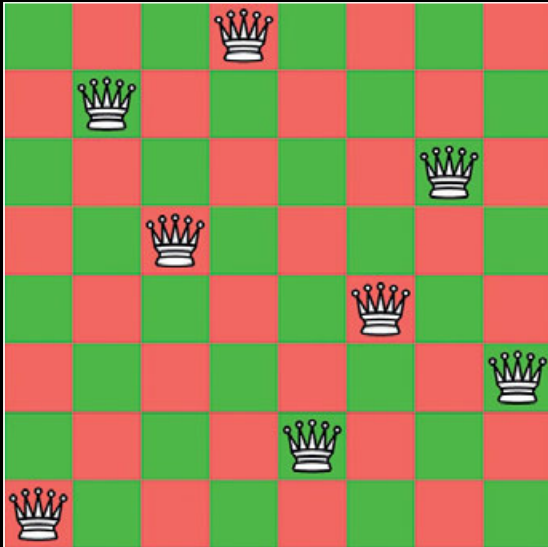

SOLVE THE EIGHT QUEENS CHESS PROBLEM ▲

► magpi.cc/JgrHLH

The eight queens problem is one that's tricky to solve as it requires you to check many, many permutations. The tutorial we've published previously (in issue #65) has been streamlined so the Raspberry Pi can run it a bit better. Now with the extra power, you can make the code a bit more complex. Can you win the big prize?

EASY RETRO GAMING ON A RASPBERRY PI ▶

► magpi.cc/BmPQxg

While old computers and consoles are far less powerful than a Raspberry Pi, emulating them properly uses up a lot of processing power. With the extra oomph the Pi 3B+ provides, true emulation is a step closer on the Raspberry Pi.

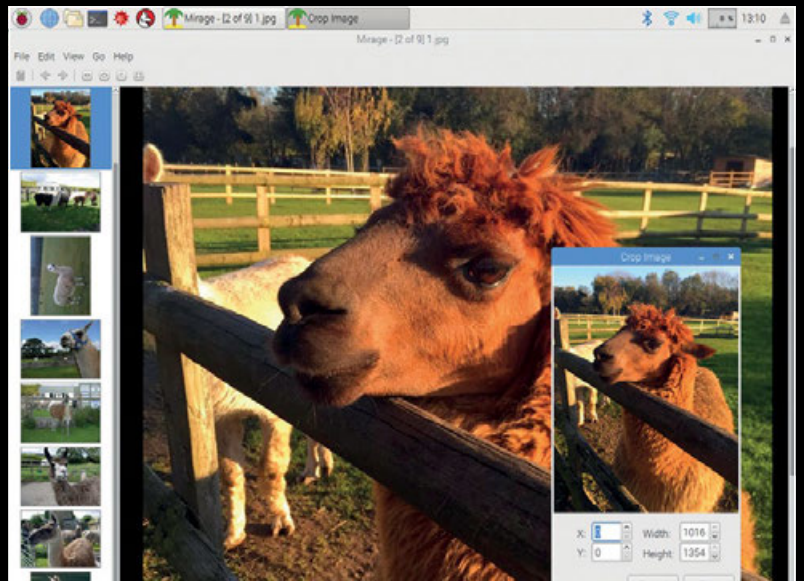

IMAGE EDITING ON YOUR RASPBERRY PI ▲

► magpi.cc/xiyAqr

Image editing uses up a fair amount of resources. While Mirage on a Raspberry Pi is a bit less power-hungry than a 50-layer Photoshop project, having a higher CPU speed to render or make changes can be very handy to help speed up your workflow

DATASCIENCEPI ◀

► magpi.cc/GBNqkB

The original version of this project uses a Raspberry Pi Zero to do some data crunching. Its creator Scott Edenbaum has tested his setup on a Pi 3 before, saying it takes about two hours to build on there and even longer on the Pi Zero. With the extra power the 3B+ affords, can it be done in under two hours?





ASTRO PI FLIGHT DATA ANALYSIS ▲

► magpi.cc/xhtNKj

Data analysis can take a while, especially if you're getting a lot of data and you want to do a large amount of processing on it. While even the Pi Zero is capable of doing some simple analysis quickly, as soon as you begin scaling it up you start to require a little more power.

SET UP A FILE SERVER ►

► magpi.cc/XJyPYq

The improved network speeds of the Raspberry Pi 3B+ make it much better suited for being a file server than ever before. It's a pretty simple setup as well, so it's worth trying out if you're thinking of how to centralise all your files on your network.

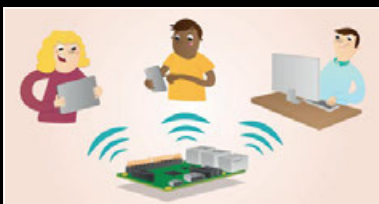

SENSE HAT DATA LOGGER ▼

► magpi.cc/CYrngd

Logging data from the Sense HAT is fairly easy for the Raspberry Pi to do. So why not use the spare processing power to do something useful with the data? Create a live analysis or crunch any numbers? It's always good to multitask if you can.

BUILD A WEB SERVER ▲

► magpi.cc/dhKtSK

This one can make use of both the Raspberry Pi 3B+'s extra processing power and enhanced network connectivity to perform better than ever before. Even the improved wireless helps out here!



BUILD A LIGHTWEIGHT PYTHON WEB SERVER ▼

► magpi.cc/bWyKaz

While similar to the LAMP server, this one is a bit lighter, meaning it uses fewer resources. Using the Raspberry Pi 3B+, you can max out your efficiency with a server running Flask, and even use your Pi 3B+ for other stuff in the meantime.



OCTAPI: CALCULATING PI ►

► magpi.cc/PptaMu

The OctaPi is a cluster computer using eight Raspberry Pis. Hence the name. Pooling the Pis' resources together helps you calculate faster, especially when it comes to irrational numbers like π (pi). What's better than eight Pi 3s? Eight Pi 3B+ boards. Time to set some speed records.



RASPBERRY PI PROJECTS 3

Discover more inspirational projects for Raspberry Pi in *The Official Raspberry Pi Projects - Volume 3* book.

► store.rpiexpress.cc

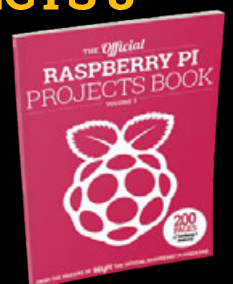

SUBSCRIBE TODAY FROM JUST £4



SAVE
UP TO
35%

Pricing

Rolling Subscription

- £4 a month
 - Quick and easy to set up
 - No long-term commitment
- * Leave any time applies to Rolling Subscription only

Subscribe for a year:

£55 (UK)

£80 (EU)

\$90 (USA)

£95 (Rest of World)

£5 FREE! MODMYPI
VOUCHER
FOR ALL SUBSCRIBERS

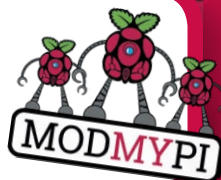

Subscription benefits:

- **FREE!** Delivery to your door
- **EXCLUSIVE!** Raspberry Pi offers and discounts
- **NO OBLIGATION!** Leave any time*

 magpi.cc/subscribe

JOIN FOR 12 MONTHS AND GET A

PI ZERO W STARTER KIT

WITH YOUR SUBSCRIPTION

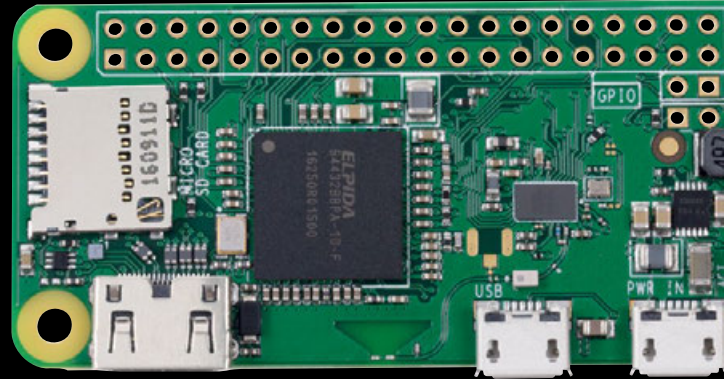

WORTH
£20



Subscribe in print for 12 months today and you'll receive:

- Pi Zero W
- Pi Zero W case with three covers
- USB and HDMI converter cables
- Camera Module connector



SUBSCRIBE ON APP STORES

Available on the
 App Store

GET IT ON
 Google Play

FROM
£2.29





JIMMY WHITE

Jimmy describes himself as a "geek, DJ, photographer and father". His son loves his TV so much, Jimmy built him one. deviousweb.com

Since it relies on a webcam rather than a source, this system works regardless of what's being shown, whether a film or game.

The colours around the edge of the screen are detected by the camera and processed so that the LEDs can match them

It doesn't matter where the camera is located in the room – it just needs a full view of the screen without glare or reflections



Quick Facts

- ▶ The software, Ambient LightServer, is open source
- ▶ One part runs on a Pi, the other on PC
- ▶ The WS2801 LED lights cost just £19.99
- ▶ You can adjust colour saturation and brightness
- ▶ Jimmy plans to add an IR sensor for remote power-up/down

AMBIENT TV LIGHTING

As well as reducing eye strain, the ambient lighting surrounding Jimmy White's goggle-box is rather eye-catching.

David Crookes takes a look

Not much beats curling up on the sofa with a lovely cup of tea and a gripping box set, but there is a slight chance that you'll become square-eyed by the time the credits roll. It's a well-known fact that watching too much TV, especially in the dark, puts a strain on your peepers. Yet while backlighting a television set helps enormously by increasing the amount of ambient light around

the screen, dedicated TVs which do this can prove rather expensive.

Realising that and already owning a decent smart TV, Jimmy White decided to make his own light setup using a Raspberry Pi 3, a USB camera, and some LED strips. He wanted to produce a bias lighting effect that took into account whatever he was watching or playing, adjusting the colour of the lighting to match the screen.

"I was inspired by the standalone ambient light offerings I have seen on the market, but they all required the 'source' to be external to the TV, which did not meet my requirements," he says.

Watching videos

Jimmy began the project by scouring YouTube for ideas. "I'd seen many videos where people were using Arduinos to drive LED

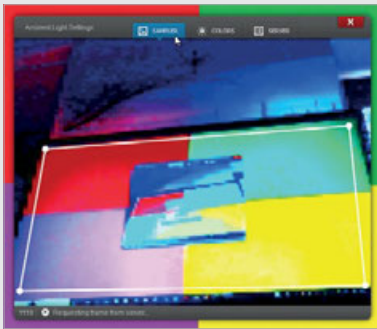

Above Jimmy created a test card so that the screen could be calibrated via AmbientLightPyClient on a PC

strips, but they all depended on the external HDMI source,” he explains. “I eventually came across a piece of open-source software written especially for the Pi on GitHub and it was just the thing I was looking for.”

The software, AmbientLightServer by Waldo Bronchart (magpi.cc/gZLhHv), works by capturing colours from the edge of a television screen using a webcam. It then uses the data it gathers to update any attached LEDs with those colours. It works very well but Jimmy had to tweak it, editing the number of LEDs in the strips, adding the location of the starting light and creating an install script (magpi.cc/rnrwEW).

He also worked with a companion app called AmbientLightPyClient, which runs on a PC and allows the edges of the screen to be defined and the colour saturation and brightness to be set. The

LET THERE BE LIGHT

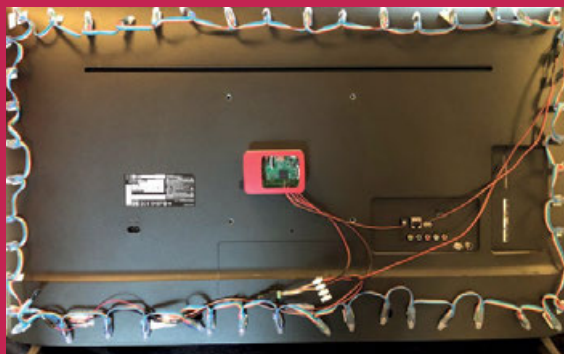

>STEP-01 Connect the LEDs

Jimmy bought a 3 metre roll of WS2801 LEDs which he cut into two strips and attached to the back of his TV. These connect to a Raspberry Pi 3.

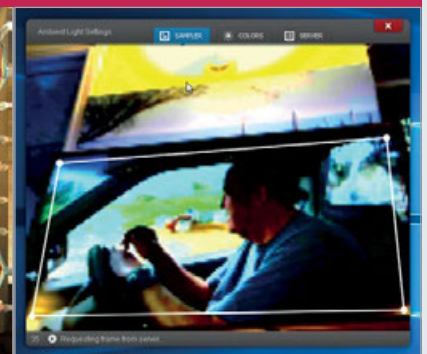

>STEP-02 Setting it up

The Pi 3 runs AmbientLightServer, driving the LEDs. A Python Qt client app called AmbientLightPyClient runs on a PC and connects to it. The sampling region and colour settings can be controlled.

>STEP-03 Sit back and watch

A webcam pointed at the display captures the TV's on-screen colours. It uses this data to tell the Raspberry Pi which colours the LEDs need to emit to create an ambient light.

the LEDs went in relation to the screen,” he recalls. “Having a strip running [in] the wrong direction, orientation, and position was rather confusing.” He used hook-and-loop fasteners to stick the



Above The power and data wires are soldered to the Raspberry Pi 3 and the software was installed to a 16GB card

“The camera detects the colours around the edge of the screen and adjusts the LEDs to match”

parts list, however, was more straightforward. Jimmy already had some Raspberry Pi 3s (“I wanted to make use of them as a low-cost solution,” he says), a 16GB memory card, and a Logitech C270 webcam, so he set about buying the LEDs and some 18-gauge electrical wire.

Wiring up

“The most difficult part was trying to work out which direction

LEDs to the back of the set in the most unobtrusive way and he tested they worked by creating his own four-colour ‘test card’. This was displayed on the screen and the camera was pointed so that it could capture the display’s full view.

“The camera detects the colours around the edge of the screen and adjusts the LEDs to match.” Jimmy reveals. Indeed, it captures

frames at a low resolution and 30 frames per second, which makes the system quite responsive. The effect of this is a more pleasurable television experience, one which gives the appearance of extending the screen into the room. “It looks really cool,” Jimmy concludes, rather pleased with the result.

The Joy-Cons are used to control the games. After much struggle, Christopher managed to get the analogue sticks working

The 3D-printed case holds the Pi 3 and other components and it includes the locking mechanism for the Joy-Con controllers



CHRISTOPHER FOOTE

Chris is a systems administrator and engineer from Olympia, Washington who is joined by his seven-year-old son and wife to help test his creative inventions and blunders.
magpi.cc/eoZylo

The 7-inch Raspberry Pi Touch Display is at the heart of the project, which also makes use of RetroPie for emulation



Quick Facts

- ▶ The Joy-Cons can be used for two-player gaming
- ▶ PiSwitch boots to Chris's own touchscreen menu
- ▶ The 6600 mAh battery offers a 2.5-hour life
- ▶ PiSwitch can also be plugged into a TV
- ▶ An optional camera was added for fun

PI SWITCH

New meets old in Christopher Foote's take on the retro-gaming handheld console thanks to Nintendo's latest innovative controllers. **David Crookes reports**

One of the most popular things to do with a Raspberry Pi is to put it at the heart of a retro gaming setup. There are myriad multi-system emulators – programs which replicate the gaming systems of old – along with some slick graphical front-ends, making it a rather straightforward process. But we still see projects that go the extra mile such as this one. PiSwitch makes great use of the Joy-Con controllers of the Nintendo Switch console to produce a beautiful handheld machine.

PiSwitch is the brainchild of 32-year-old Christopher Foote who, as a child, would get one

game a year to play (“two if I was lucky,” he says). He recalls spending countless hours trying to accomplish everything he could in those titles. “But there were always many games that I wanted to play but I couldn’t,” he laments.

Spurred on by this, he began using RetroPie a few years ago to enjoy games made for systems as diverse as the Atari 2600 and Mega Drive. But although he ran it on a Adafruit's PiGRR2, he found the buttons were sticky and he didn't like the screen. “Then my wife got a Nintendo Switch for my son and when I played with it I realised the controllers were exactly what I needed for my device,” he tells us.

Having discovered the Switch Joy-Cons were Bluetooth devices, Christopher got to work pairing them with a Raspberry Pi. “I spent a lot of time trying to connect two of them to work as a single controller and I thought if I could solve that problem, then the rest would be a cakewalk,” he says.

Mapping controls

He compiled Linux Joystick Mapper on his Pi 3 before mapping the controllers to keyboard keys and mouse buttons. “It worked great apart from the analogue sticks, so I looked through the code for a few hours, figured how Linux Joystick Mapper worked, and reprogrammed it for Joy-Con compatibility.”

Knowing his project was possible, he could then get to work on refining it. He soldered a headphone jack to the Raspberry Pi so that he could listen to the games when commuting. He then sought to boost the battery life by soldering a power board and switch. A speaker was also added, along with a Pi V2 Camera Module (although this, he admits, was optional and included for fun). A case was printed and the components assembled inside before a 7-inch touchscreen was added.



The side of the case has been designed so that the Joy-Cons can lock into place

Fitting perfectly

One of the lovely parts of the build is the way the Joy-Cons click into place to the left and right of the screen, just like on a Nintendo Switch. “I took my Switch and

load different controller maps.” This ensures they work well with retro games whether as a single controller or separate ones, but also as a mouse or to flip through media on Kodi, which he also installed.

“ I realised the controllers were exactly what I needed ”

a pair of digital calipers and I measured the inserts for the controllers,” Christopher says, getting the fit just right.

The two controllers make the PiSwitch versatile. “I can play one-player with both controllers to fully emulate a Nintendo 64 or PlayStation controller,” he explains. “The Joy-Cons also

In the near future, Christopher is going to work on refining the case and the overall look of the console. “I’m also looking to add support for streaming via Steam,” he says. “I think being able to play games from your desktop anywhere in the house with the comfort of a handheld device would be a really cool feature.”

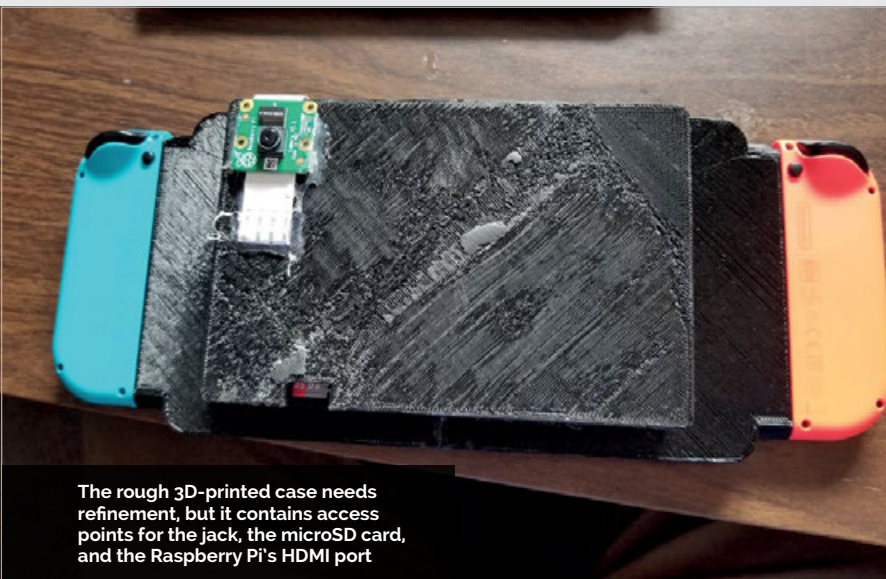

The rough 3D-printed case needs refinement, but it contains access points for the jack, the microSD card, and the Raspberry Pi’s HDMI port

SWITCH ON TO RETRO GAMING



>STEP-01

Connect the controllers

The controllers must be woken at the boot menu by tapping the + and – buttons. “Nintendo makes the Joy-Cons go to sleep when they’re not in use, to save battery,” says Christopher.



>STEP-02

Select RetroPie

Christopher created his own touchscreen menu and included RetroPie, Kodi, and Debian. “RetroPie has a huge community, so with research you’ll find someone who’s done part of what you’re trying to figure.”



>STEP-03

Play a game

You need to copy a game ROM to the microSD card. This is a digital version of a game cartridge. By selecting the right console and the game in RetroPie, you can have some fun.



CHRIS CAMPBELL

A San Francisco-based software developer by day, Chris is a keen photographer and a musician, recording music under the pseudonym La Bonne Soupe. labonnesoupe.org

Quick Facts

- The name comes from 'QR' and 'crocodile'
- It can play music in a selected room
- QR codes are glued onto pieces of card
- Qrocodile has voice feedback
- It currently supports ten commands

QR OCODILE

A snappy idea, making it easier to control a Sonos multi-room speaker system, as **Nicola King** discovers

Keen to find a way to enable his young children to quickly and easily search for and play their favourite music tracks on the family's Sonos sound system, Chris Campbell had a brainwave. "Usually my kids ask me to play certain songs that they already know, and then I have to use the Sonos app on my phone or computer to hunt them down. One night at the dinner table I was lamenting how many steps are involved in using the

Sonos apps to search for music or to enable the turntable... That's when the seed of an idea was planted."

Initially he thought of creating a simple button that just enabled the vinyl turntable linked to the Sonos, but grander plans soon started to take shape, centred on the use of QR codes.

Scanning for codes

Printed on cards, the QR codes are read by a mini camera connected to

a Raspberry Pi 3, housed in a LEGO crocodile case. "When my software sees a QR code that it understands (for example, a code representing a music library track), it builds up and sends the appropriate request(s) to the Sonos system," explains Chris. In addition to playing tracks, some of the cards contain commands such as 'Play music in living room' or 'Build a list of songs'. The qrocodile also speaks to you, to tell you what it is doing!

Each card has a unique QR code on the reverse

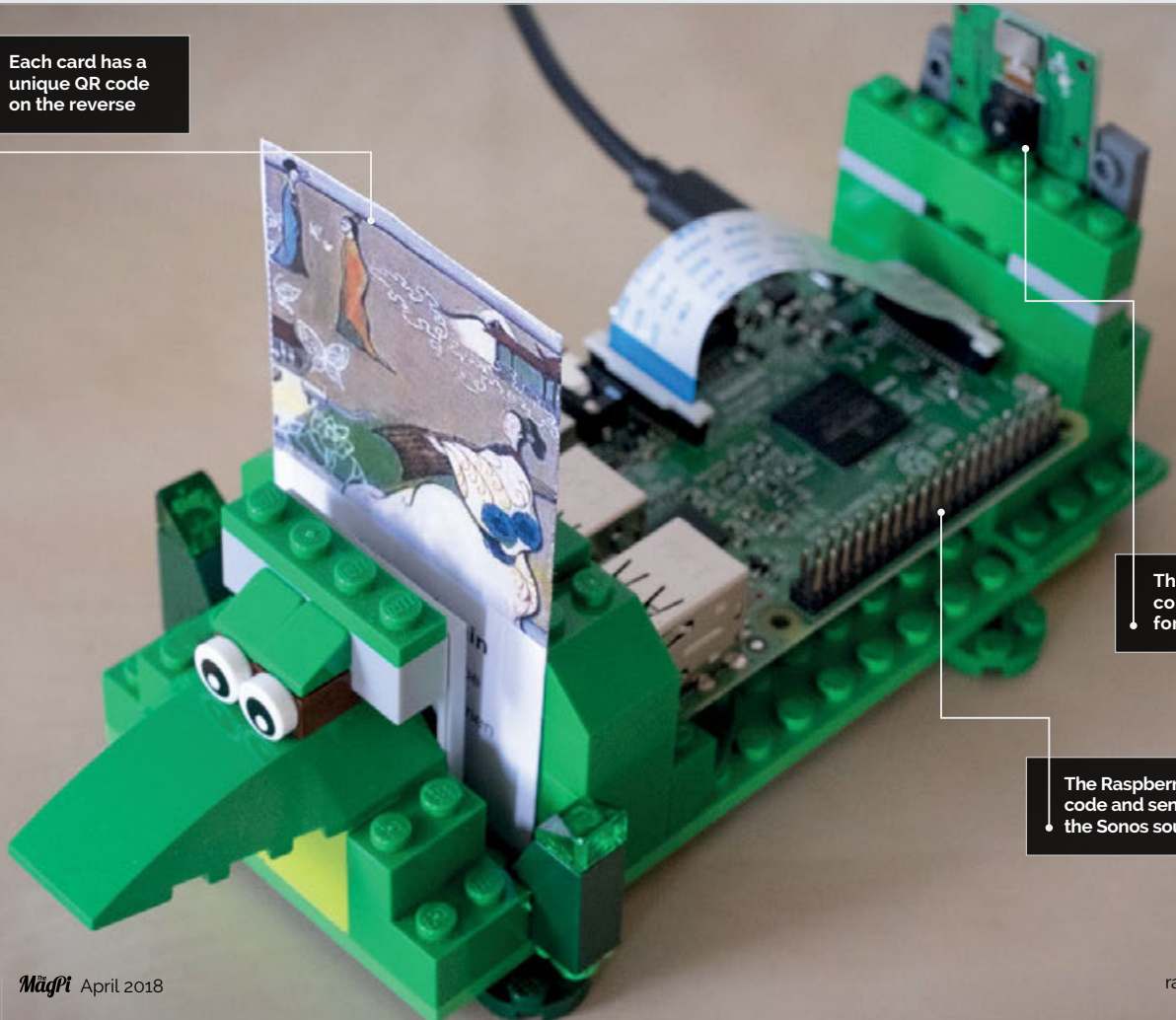

The mini camera continually scans for QR codes

The Raspberry Pi interprets the code and sends a command to the Sonos sound system



Above The cute croc-shaped case is built from his son's green LEGO bricks

Chris spent around four weeks working on the project in his spare time, ironing out several issues along the way, such as with the QR encoding algorithm. His first implementation simply encoded the full artist, album, and song title metadata in the QR code. "This worked fine for short names/titles, but not so well for songs or albums with really long titles. It hadn't occurred to me that the more information you cram into a QR code, the tinier those little black

So, what do his children think of their dad's invention? "They love it! My son likes that it allows him to be in control of the playlist for their dance parties. My daughter enjoys being able to play her favourite song *Starman* over and over."

No crocodile tears

So far, no qrocodile-related fights have broken out between the kids. "They picked up on how to use it almost immediately."

For those who'd like to build one, Chris has supplied full instructions

“ QR codes are read by a mini camera connected to a Raspberry Pi 3

and white squares get. And the smaller those squares get, the harder it becomes for the camera to read.”

His solution was to apply a hash function to the metadata, so that only a few characters need to be stored in the QR code in order to identify a song. "After making that change, the QR codes were much less fine-grained and could be read easily by the Raspberry Pi-attached camera."

on GitHub ([magpi.cc/CxZokQ](https://github.com/magpi.cc/CxZokQ)).

"My qrocodile is just one incarnation of a concept; I'm interested to see what sort of tweaks and variations other people come up with on their own!"

Still working on perfecting the project, he has plans to add extra commands such as a weather forecast. He'd also like to explore making the qrocodile work with NFC-embedded cards, and creating a smaller version using a Pi Zero W.

CREATING A QROCODILE



>STEP-01

Croc case

The crocodile-shaped case houses the Raspberry Pi 3, QR code card holder, and mini camera. It's built from green LEGO bricks belonging to Chris's son. This was the easiest part of the project.



>STEP-02

Generate codes

A Python script takes a list of songs (from your local music library and/or Spotify), as well as commands, and generates cards with an icon and text on one side and a QR code on the other.



>STEP-03

Play the music

Another Python script run on the Raspberry Pi scans the QR code with the camera and acts upon it, using a custom fork of `node-sonos-http-api` to access the Sonos sound system and play the music.

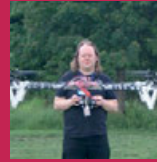

GAVAN FORTUNE

Gavan has a background in software and electronics and enjoys music, flying, and making things.
coolfactor.org

Quick Facts

- > The display weighs around 2.5kg
- > 64 pixels are rotated into view by servos...
- > ...Driven by three Pololu Mini Maestro 24 boards
- > 448 3D-printed components were required
- > It took over two weeks of solid 3D-printing time

PIXEL

ELECTROMECHANICAL DISPLAY

Featuring an ingenious rotating pixel design, Gavan Fortune’s electromechanical matrix display is most impressive.

Phil King reports

Looking to create a decorative project for his office party, Gavan Fortune decided that a standard LED matrix display would be too obvious. “Somehow I started thinking about electromechanical things like the flip-dot display and wondered what I could do that would be a little bit different,” he tells us.

The result is the Pixel, an amazing electromechanical matrix display controlled by a Raspberry Pi (magpi.cc/tcMzFz). Each of its 64 ‘pixels’ is turned on and off by a servo rotating a 3D propeller-like shape to reveal its bright yellow vanes from a black casing.

Unique design

“I don’t know of any other implementation of this shape for a display,” says Gavan. “The idea came from the AWS visual display (a.k.a. sunflower) in a train cab, which in its active state displays interleaved yellow and black segments, but this was an exercise in extending the yellow part to cover the whole circle. This is not possible to do with a part rotating behind a shutter, and meant that there had to be a third dimension to the moving part.”



Comprising seven 3D parts, each pixel is turned by a servo at the rear

As a pixel is rotated, its vanes emerge from the black casing

Monitor stands add extra support to the matrix to prevent it flexing

MAKE A MECHANICAL MATRIX



>STEP-01 Printing pixels

Gavan designed the pixel elements and casings. Each pixel comprises seven 3D-printed parts, one servo motor, and two nails to transmit the latter's rotation to reveal the vanes from the casing.

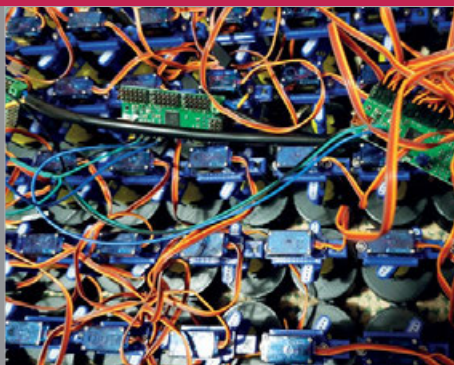

>STEP-02 Driving servos

To drive 64 servos from one Raspberry Pi, three Pololu Mini Maestro 24 boards are used. The software is written in Python and scrolling text is generated as an animated 8x8 GIF.

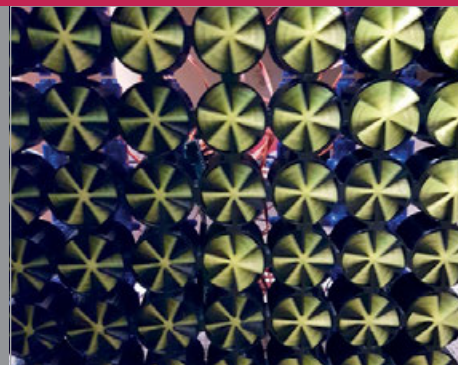

>STEP-03 Matrix assembly

While the 64 pixel cases slot together to form the shape of a grid, it's not quite strong enough to support itself without flexing, so Gavan added a couple of monitor stands at the sides.

Unlike in a traditional flip-dot display, the 3D-printed pixels can be rotated to intermediate positions to achieve greyscale-

from emitting data to the servo controllers faster, but the servos do take a little while to rotate. Too high a frame rate just leads to

“ The 3D-printed pixels can be rotated to intermediate positions for greyscale shading ”

style shading. “There are definitely things you can do with this display that you couldn't do with a two-state display. Perhaps my favourite has to be a ripple effect.”

The Pixel display can show animations, too. “The frame rate is just a few frames per second,” reveals Gavan. “There's nothing stopping the software

ghosting effects on high-contrast features such as text.”

Two phases

In total, from concept to finish, the Pixel took Gavan three and a half weeks to make, split between design and manufacturing phases.

“The design phase involved learning about screw threads

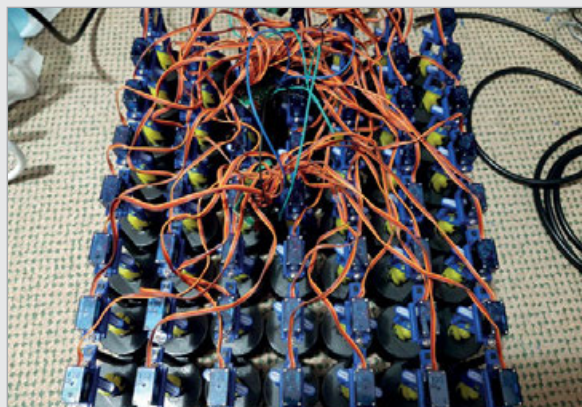

Above Wiring all 64 servos took longer than figuring out basic communication with the Pololu Mini Maestro 24 controller boards

and what can be 3D-printed. The first few iterations of the design had various problems with friction and sticking, which were resolved by having two separate screw threads – one to drive the correct motion and one for the display element.”

Due to time pressure, Gavan had to live with a few design issues. “The end result is that some parts are a bit fragile, leading to reliability issues.”

While much of the design is robust, there are two places where the pixels are prone to failure, and a few have broken. “The fix is quite straightforward but does involve reprinting four parts per pixel. I will probably do that once I have run out of spare parts.”

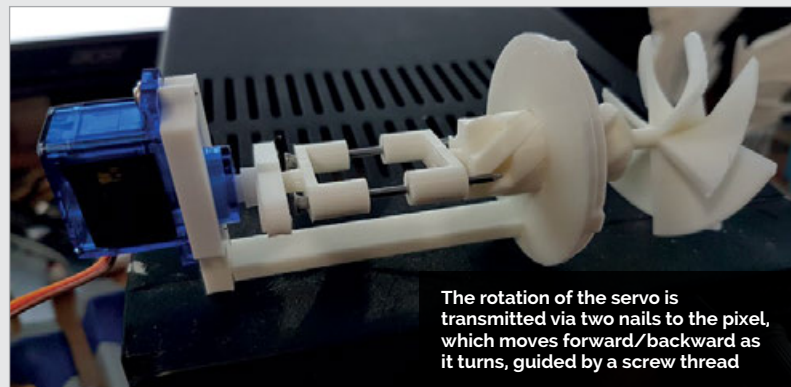

The rotation of the servo is transmitted via two nails to the pixel, which moves forward/backward as it turns, guided by a screw thread

INSTALL UBUNTU MATE ON YOUR RASPBERRY PI

Try out this alternative operating system on your Raspberry Pi

You'll Need

- ▶ microSD card
- ▶ Ubuntu MATE
- ▶ Raspberry Pi

Ubuntu is a big name in the Linux world. Like Raspbian it's based on Debian architecture, but it's run by Canonical Ltd which offers commercial support.

It's one of the most popular operating systems in the world and there's a version available for the Raspberry Pi. Called Ubuntu MATE (pronounced mah-tay), it uses the Ubuntu operating system with the MATE desktop environment. MATE is based on GNOME 2, a popular interface.

Ubuntu MATE is an alternative to Raspbian and a lot of fun to experiment with. It is more resource-hungry, and doesn't have the wealth of programming tools or community support of Raspbian, but it is a popular OS outside of Raspberry Pi and worth investigation – especially with the new faster Raspberry Pi 3B+.

Head to ubuntu-mate.org/download and click on Raspberry Pi and 16.04.2 (Xenial). Click on Download Link (or choose the magnet link if you want to be a good citizen and use a Torrent download to save on the bandwidth).

Now, use Etcher to copy the image file to your microSD card (magpi.cc/etcher). When ready, put the SD card into your Raspberry Pi and power it up.

System configuration

The first time you boot Ubuntu MATE, it displays a System Configuration window that requires you to create a user (with a password).

Choose your language (English is the default selection) and click Continue. Now you need to choose your WiFi network and fill out the password field; click Connect and Continue.

After that, you need to create your location settings. Choose your location on the map and pick your Keyboard Layout.

Finally, you get to make your user. Fill out the 'Your name' and 'Pick a username' fields and enter a password. Click Continue to complete the system installation.

Boot and interface

Every time you boot into Ubuntu MATE, you'll need to select your user and enter the password.

A Welcome window greets you. Click on the various buttons to take a tour of the system. Click Close when you're ready to start using the operating system. The Welcome page will open every time you boot up Ubuntu MATE; deselect the 'Open Welcome when I log on' option tick and click Close if you don't want to see it again.

The MATE desktop environment will be familiar to anybody who has used a GUI before. Unlike

Applications and system configuration tools can be accessed using the menus in the top-left

Ubuntu MATE boots to this Welcome screen. Select options to learn about the OS and deselect the checkbox if you don't want to see it again

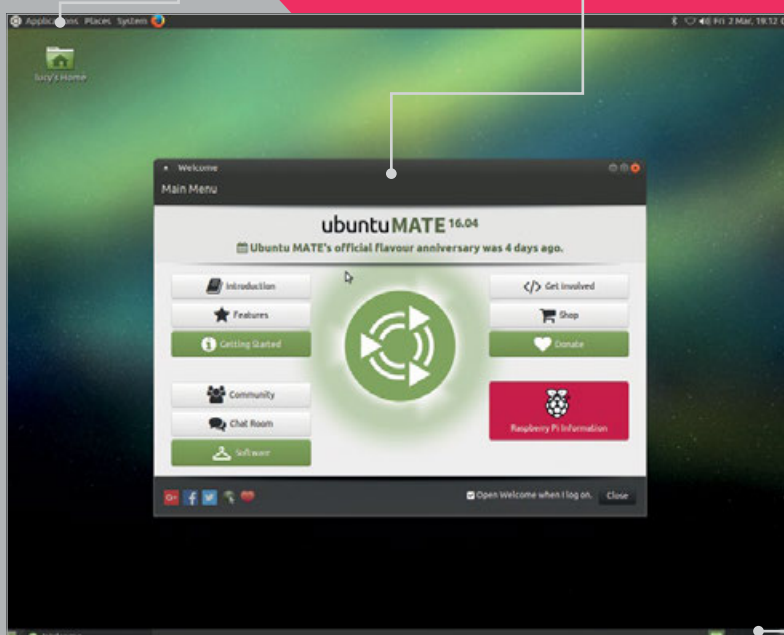

Click on these square icons to swap between different virtual desktops

Raspbian, there are two panels at the top and bottom of the screen. The one on the top has Applications, Places, and System (plus an icon for Firefox, the web browser). In the top-right are icons for Bluetooth and Network, plus the Clock and Shut Down icons.

The bottom panel has a couple of interesting items. On the left is a Show Desktop icon. Clicking it hides all the current windows, enabling you to view the desktop.

Meanwhile, over to the bottom-right is a Workspace Switcher. You get four different workspaces (virtual desktops) by default. Clicking on any of the four screens lets you switch between them. It's like having four different monitors and being able to jump between them (which is great if your screen gets cluttered up with windows).

Applications

Clicking on the Applications in the top-left accesses all the built-in software. Ubuntu MATE has a vastly different selection to Raspbian.

Firefox is the stock web browser. Open it using the icon in top panel, or choose Applications > Internet > Firefox Web Browser.

You'll find plenty of other apps to explore inside the other folders. Some – like Scratch 1.4, IDLE, and LibreOffice – you'll be familiar with. Others – like Minecraft Pi, Sonic Pi, and Sense HAT Emulator – are Raspberry Pi-specific software found in Raspbian and Ubuntu MATE.

There's a lot of office software – like Pidgin internet Messenger, Thunderbird Mail, and HexChat – to explore. And media programs like VLC Media Player, Rhythmbox, and Shotwell enable you to access video, music, and photo documents.

All of the options can be found in the System folder. Be sure to check out the Administration > Software Boutique program. Here you'll find a curated selection of additional programs you can install.

You can access a Terminal window using Applications > System Tools > MATE Terminal

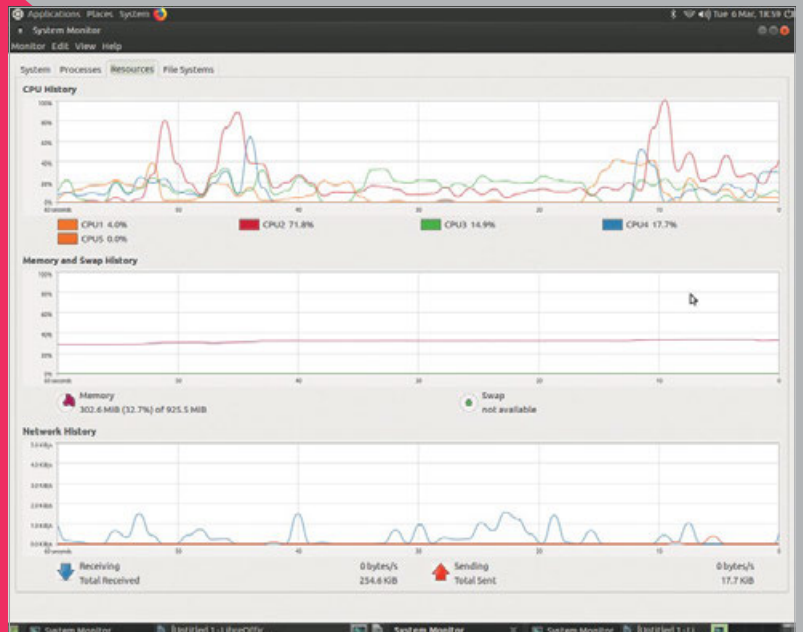
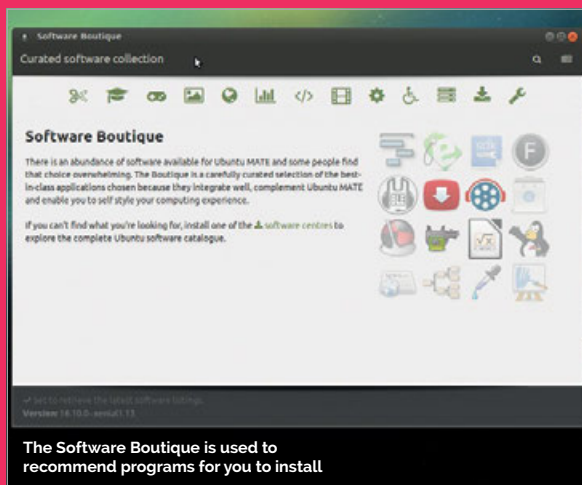

Above: System Monitor provides detailed information on the resources being used by Ubuntu MATE and its various components

or by pressing CTRL+ALT+T. (Don't forget, you can also drag icons to the panel for faster access.) Ubuntu MATE also supports virtual TTY desktops, which you can switch between using CTRL+ALT+F1 to F6. Press CTRL+ALT+F7 to return to the main TTY desktop.

System Monitor

Take a look at Applications > System Tools > MATE System Monitor. Here you can find detailed information about your Raspberry Pi, including the memory, processor, and available disk space. Click the Processes tab to see what items are

“ Ubuntu MATE is an interesting alternative to Raspbian, the officially supported operating system ”

running (and you can end stalled processes using the End Process button). The Resources tab enables you to see CPU, Memory, and Network usage over time.

Ubuntu MATE is an interesting alternative to Raspbian, the officially supported operating system. It lacks a lot of the functionality, especially advanced programming tools like Thonny and Scratch 2.0. And there are no built-in links to all the resources developed by Raspberry Pi, which makes it less useful for learning programming. It's also a bit of a resource hog compared to the lightweight approach of Raspberry Pi Desktop.

But if you want to try out a different operating system, and use a bunch of powerful software on the Raspberry Pi, it's well worth a look.

MIKE'S PI BAKERY



MIKE COOK

Veteran magazine author from the old days and writer of the Body Build series. Co-author of *Raspberry Pi for Dummies*, *Raspberry Pi Projects*, and *Raspberry Pi Projects for Dummies*. magpi.cc/259aT3X

MIDI DRUM SEQUENCER

Make your own nine-channel drum sequencer

You'll Need

- > MIDI sound generator
- > Four potentiometers with knobs and coloured tops
- > Box for pots like the Maplin FT31
- > Stripboard: 17 strips of 14 holes
- > MCP3008
- > 16-pin IC socket
- > Bottom-entry twin-row header sockets, 24 contacts at least
- > 10-pin single-row header socket
- > 1 × 0.1 uF ceramic capacitor

A drum sequencer, or drum machine, is a staple part of virtually every music making system. Gordon Sumner (who, for younger readers, is also known as Sting from the rock combo The Police) once joked that the difference between a drum machine and a drummer was that you only had to punch the rhythm into a drum machine once. So we are going to show how to make your own drum machine using Python on the Raspberry Pi.

The MIDI sound module that we made in Pi Bakery in *The MagPi* #63 has a set of percussion voices that

we mentioned in passing. These cover both General MIDI 1 and General MIDI 2 standards. General MIDI (GM for short) is an agreed mapping between an instrument number and its description. Before the advent of GM, it was down to the equipment manufacturer to assign what instrument number produced what sound; this meant that to get correct MIDI playback you had to use the same sound module as was originally used when creating the MIDI files. Some sound modules still have their own sound mapping, but GM does make things a lot more flexible.

For percussion, things are a little different from the normal melodic instruments. Where, if you select say a tuba, using program message 59, then the note-on-message numbers give you different notes of the music scale played on a tuba. With the percussion, if you select a percussion bank, the percussion instrument you get will depend on the 'note on' message number. Valid numbers range from 27 to 87, so that is 60 different instruments.

Note here how we said that the sound description is standardised; this does not mean the actual sound will be exactly the same. So while in percussion a 'note on' number of 60 is described as a 'High

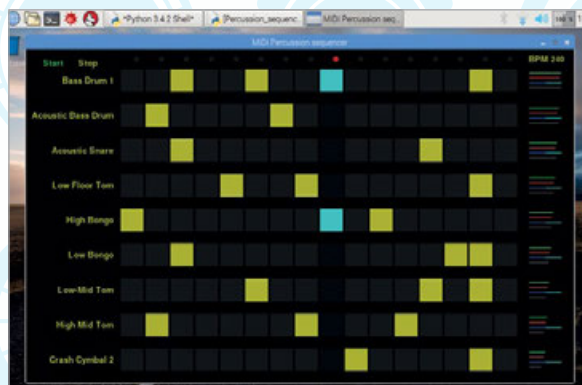
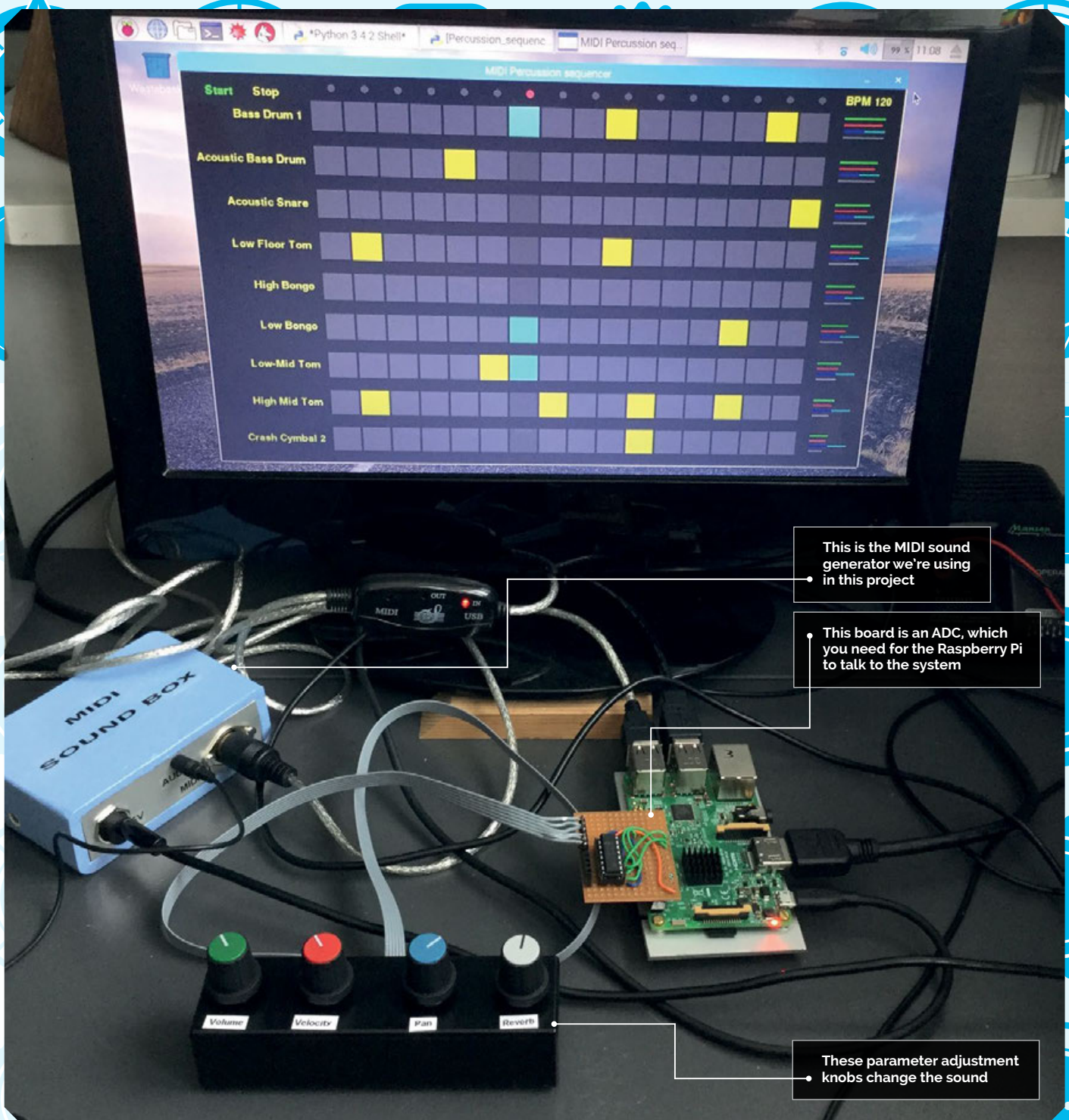

Figure 1 The screen layout for the drum sequencer



Bongo', how good this actually sounds will change from synth to synth.

Design

Most drum sequencers generally have the same form of grid layout: horizontal rows define the firing point in a sequence for one instrument, and these rows are stacked for as many instruments as you want to have playing in your loop. The length of the row defines the number of beats or hit points you have

in a sequence and while we have decided to have 16 hit points, you can, with a software option, make it repeat after the first four or first eight hit points. For a sequence length of four, the hits are every beat in a bar or whole notes. Half notes give you a sequence length of eight, whereas quarter notes produce a length of 16 steps. So the **W**, **H**, and **Q** keys define the number of steps in a sequence.

In addition, you want to be able to select at what point an instrument sounds; for that, the grid

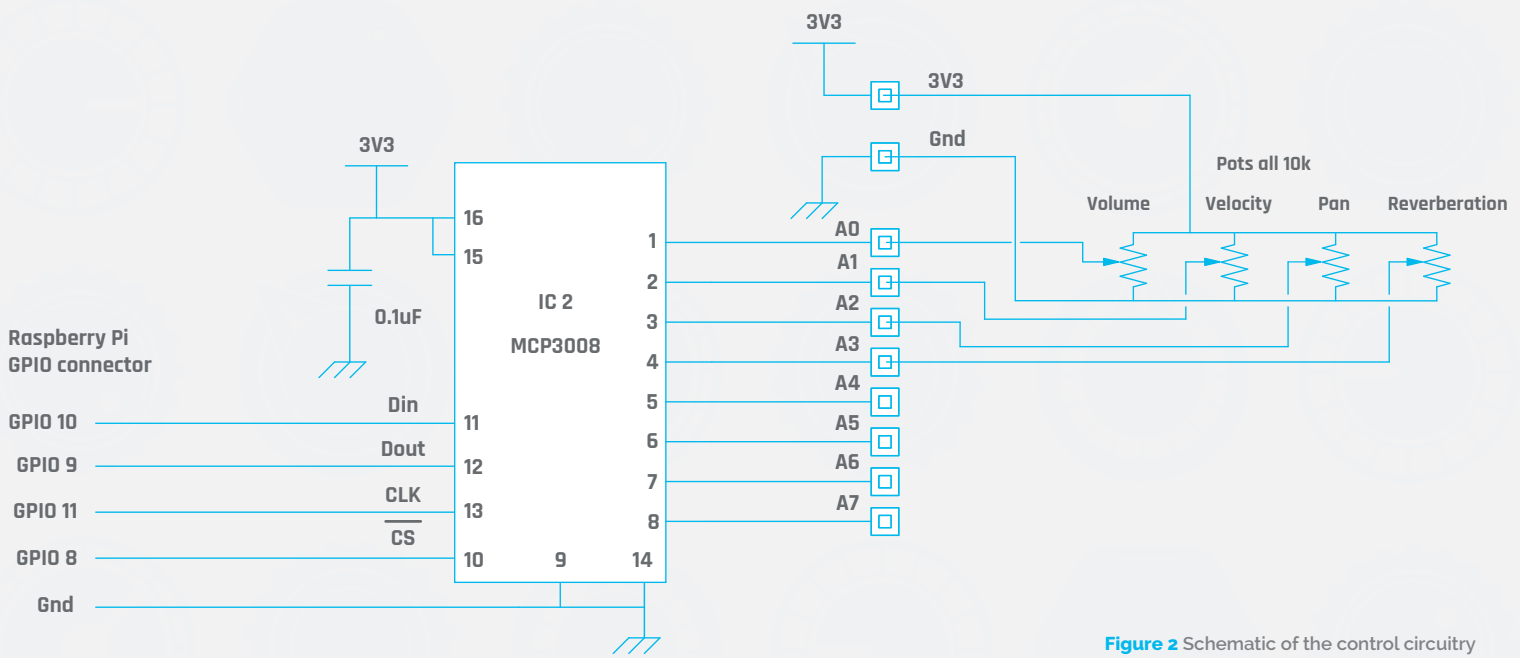
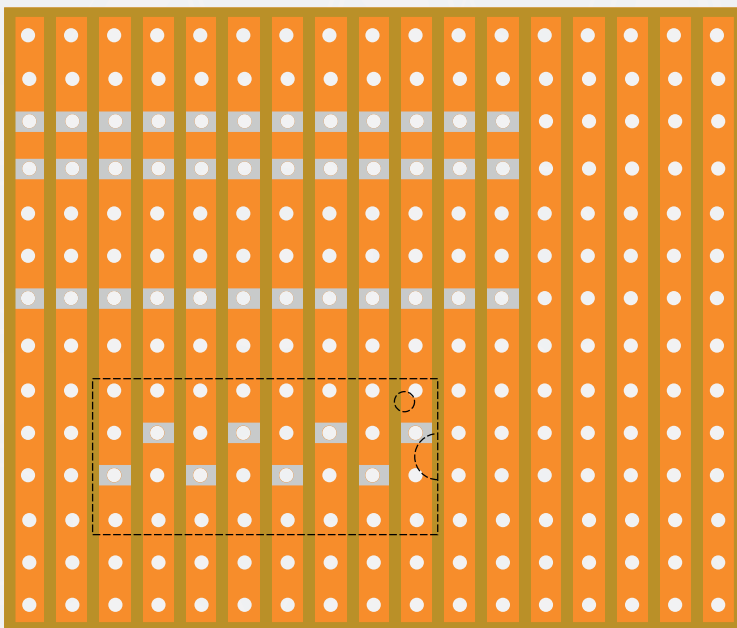

Figure 2 Schematic of the control circuitry

MAKING THE CONTROL INTERFACE BOARD

>STEP-01 Preparing the board

Take a piece of stripboard 17 strips wide by 14 holes high, and break the tracks shown by the light grey areas (below) with a scalpel or spot face cutter. The dotted lines show the positions of the IC socket. Most of the board will hang over the side of the Raspberry Pi.



squares are clicked to select firing or not. You also need to start and stop the sequencer. In order to get a good mix, you need to be able to control the volume and the hit velocity of each instrument, its position in the stereo field, known as pan, and also control the amount of reverberation applied. This is done by using four knobs to adjust each parameter. Only one sound can be adjusted at a time, but once adjusted, its settings are stored and the next channel can be adjusted. The instrument adjusted by the knobs is selected by the number keys **1** to **9** on the keyboard, with the **0** key locking all instruments against change. Coloured lines representing each parameter are drawn over on the right of the screen, with each colour matching the top of the labelled knob. The screen layout is shown in **Figure 1** (page 40).

The **-** and **+** keys alter the speed of the steps, and the **C** and **R** keys clear the grid and reset the sequence. The **I** key is when you want inspiration: it gives you a starting point for a rhythm.

The hardware

The hardware consists of four potentiometers in a box connected to an analogue-to-digital converter (ADC) attached to the SPI GPIO pins of the Raspberry Pi. We used an MCP3008 eight-channel converter,

>STEP-02 Underside of the board

Mount and solder the bottom-entry socket to the strip side of the board. You need to make the joint at the point where the connectors pass through the holes to the component side. Also, we soldered a surface-mount capacitor between the ground and power tracks. Mount the IC socket and ten-pin header from the other side of the board and solder them to the tracks.

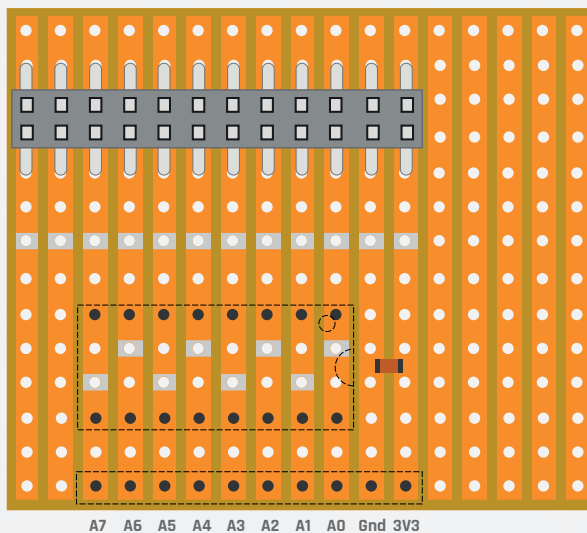

>STEP-03 Wiring up

Wire up the chip and GPIO socket according to **Figure 2**; a physical representation of this is shown below. Note the wire from the power strip goes to pin 16 of the chip and carries on under the board to pin 15 of the chip. The analogue inputs to the chip are in the correct order for the header strip.

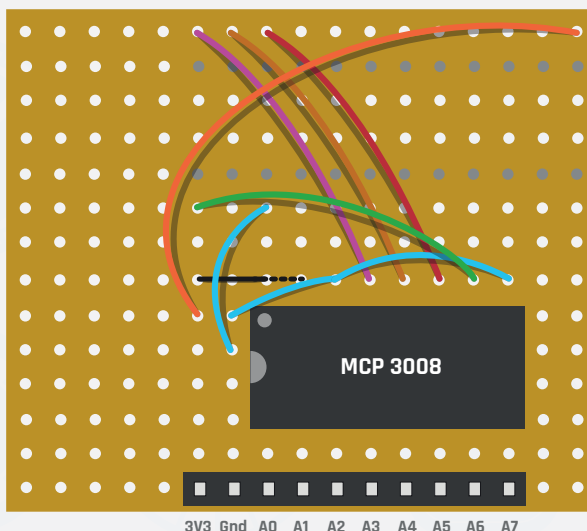

but could have used the smaller MCP3004, as we did in the Ribbons project in *The MagPi* #49. There is no need to make this if you don't want to: there are many ready-built ones about. Even the excellent RaspPiO Inspiring LED driver interface board has the option to fit this chip. If you do want to make one, the schematic is shown in **Figure 2** and full construction details are in the step-by-step guide.

Software design

While we're using our normal Pygame framework, this project posed a bit of a problem when it came to selecting the instrument for each track. The obvious solution is a menu, but Pygame doesn't support them, especially one with a choice of 60 instruments, so to get round this we have to be slightly devious. The solution we came up with is to use the Tkinter framework to create a very small window with just a menu button visible, then clicking on that button would open the menu. This produced a further complication in that we wanted this menu to pop up in the place we clicked. It turns out that Tkinter requires a mouse position based on the whole screen, whereas Pygame tells you about the mouse position referenced to the Pygame window. To get round this we had to import the pymouse module, which is now part of the pyuserinput package. So we had to type into a Terminal window:

```
sudo pip-3.2 install xlib
sudo pip-3.2 install pyuserinput
```

The action to change an instrument is to click on the existing instrument name, where it will be outlined in red. When the mouse is released, the menu window appears under the mouse; click and hold will bring up the full menu and a release over the required instrument selects it.

As there are a lot of objects to click on, we use the rectangle data structure and the rectangle and point

>STEP-04

The potentiometer box

Drill 7 mm holes for the shaft of the pots. Then push the pots in from the top of the box to mark the place for the anti-rotation pip. Use a 1 mm drill or router to make a slot for this pip so the pot sits flush. If you must, you can cut off the pip. Wire up the pots before mounting them in the box to make things easy for yourself. Fit the knobs, tops, and labels. Connect to the board as per **Figure 2**.

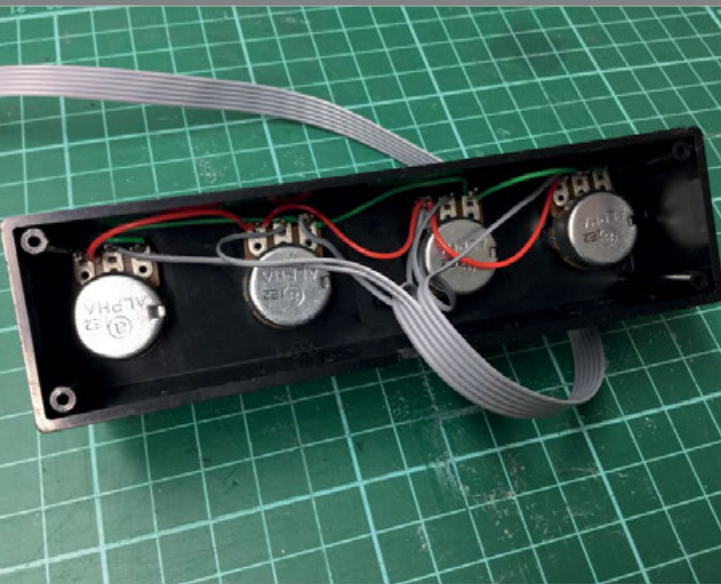

collide function to see what object, if any, has been clicked on.

The software

The `Percussion_sequencer.py` listing shows the code, and the program is basically running the sequencer or not – defined by the variable `running`. In reality the rhythm tracks 1 to 9 are actually the MIDI channels 15 to 7. The global reverberation is set to a maximum and the local channel reverberation is tamed by the controls. The software reads a file, `percussion.txt`, comprising a list of instruments called; this is taken from the data sheet of the VS1053 chip we used for the MIDI sound box, but this project will work with any MIDI sound generator.

Taking it further

While this is designed for a 4/4 time signature, the number of hit points that define the sequence repeating length can be changed for alternative time signatures. So if you want to play in 15/16 time, say, change the variable `beat` to be set to 15 on the press of some key in the `checkForEvent` function. Another useful addition would be a box to the left of the screen to mute individual tracks. You could replace the variable controls and ADC with key presses that increment or decrement the various parameters.

Percussion_sequencer.py

```
001. # MIDI percussion sequencer with Pots control
002. # By Mike Cook February 2018
003. import pygame, os, time, random
004. import functools, rtmidi
005. from pymouse import PyMouse
006. from tkinter import *
007. import spidev
008.
009. midiout = rtmidi.MidiOut()
010. pygame.init() # initialise graphics interface
011. os.environ['SDL_VIDEO_WINDOW_POS'] = 'center'
012. pygame.display.set_caption("MIDI Percussion sequencer")
013. pygame.event.set_allowed(None)
014. pygame.event.set_allowed([pygame.KEYDOWN,
015.                             pygame.MOUSEBUTTONDOWN, pygame.QUIT, pygame.MOUSEBUTTONUP])
015. textHeight=26 ; font = pygame.font.Font(None, textHeight)
016. screenWidth = 1100 ; screenHeight = 670
017. padXm = screenWidth-100 # maximum X of pads
018. screen = pygame.display.set_mode([screenWidth,
019.                                   screenHeight],0,32)
020. instRect = [ pygame.Rect((0,0),(0,0)) for i in range(0,9) ]
021. # instrument name rectangles
021. instNumber = [9, 8, 11, 14, 33, 34, 20, 21, 30]
022. # default instrument numbers
022. stopRect = pygame.Rect((0,0),(0,0));startRect =
023. pygame.Rect((0,0),(0,0))
023. instToChange = 0 ; step = -1 ; random.seed() ; showControls
024. = False ; controls = 0
024. padCols = [(28,28,28),(180,180,0)] ; playCols =
025. [(20,20,20),(50,200,200)]
025. lastStep = time.time() ; running = False ; bpm = 240
026. # beats per minute
026. potValue = [0,0,0,0] ; beat = 16 ; black= (8,8,8)
027.
028. def main():
029.     global master
030.     createMatrix()
031.     initMIDI()
032.     loadResource()
033.     pygame.draw.rect(screen,black,(0,0,screenWidth,
034.                               screenHeight),0)
034.     drawScreen()
035.     setBPM()
036.     while(1):
037.         checkForEvent()
038.         if showControls :
039.             readPots()
040.         if not running :
041.             time.sleep(0.05) # let other code have a look in
042.             if time.time() >= (stepTime + lastStep) and running:
043.                 nextStep()
044.
045. def nextStep():
046.     global step, lastStep
047.     lastStep = time.time()
```

```

048.     step += 1
049.     if step >= beat:
050.         step = 0
051.     drawLeds(step)
052.     drawPads() # wipe out last playing colour
053.     drawPadsC(step)
054.     pygame.display.update()
055.
056. def drawScreen():
057.     global instRect, stopRect, startRect
058.     drawLeds(step)
059.     drawPads()
060.     drawControls()
061.     pygame.draw.rect(screen, black, (0, 0, 184,
screenHeight), 0)
062.     for lab in range(0, 9):
063.         instRect[lab] = drawWords(iNames[instNumber[lab]]
, 176, 53+(lab*70), (180, 180, 0), black)
064.         if running :
065.             startRect = drawWords("Start", 75, 18, (0, 180, 0),
black)
066.             stopRect = drawWords("Stop", 144, 18, (180, 180, 0),
black)
067.         else:
068.             startRect = drawWords("Start", 75, 18, (180, 180, 0),
black)
069.             stopRect = drawWords("Stop", 144, 18, (0, 180, 0),
black)
070.     pygame.display.update()
071.
072. def drawLeds(n):
073.     pygame.draw.rect(screen, black, (174, 0,
padXm-174, 33), 0)
074.     for sq in range (0, beat):
075.         if n == sq:
076.             pygame.draw.circle(screen, (190, 28, 28),
(174+38+(50*sq), 20), 6, 0)
077.         else:
078.             pygame.draw.circle(screen, (28, 28, 28),
(174+38+(50*sq), 20), 6, 0)
079.
080. def drawPads():
081.     pygame.draw.rect(screen, black, (184, 33,
padXm-190, screenHeight), 0)
082.     for row in range(0, 9):
083.         for sq in range (0, 16):
084.             pygame.draw.rect(screen,
padCols[matrixCont[row][sq]], matrixRect[row][sq], 0)
085.
086. def drawPadsC(c):
087.     for row in range(0, 9):
088.         pygame.draw.rect(screen,
playCols[matrixCont[row][c]], matrixRect[row][c], 0)
089.     if running :
090.         for row in range(0, 9):
091.             if matrixCont[row][c] > 0 : #play note
092.                 ch = 15-row
093.                 midiout.send_message
([0x90 | ch, instNumber[row]+27,
velocity[row]]) # channel note
velocity
094.
095. def drawControls():
096.     pygame.draw.
rect(screen, black,
(padXm-6, 0, screenWidth, 30), 0)
drawWords("BPM "+str(bpm),
padXm+80, 10, (180, 180, 0), black)
pygame.draw.
rect(screen, black, (padXm-6, 38, 4, screenHeight), 0)
if showControls:
pygame.draw.line(screen, (180, 180, 0), (padXm-
6, 40+(controls * 70)), (padXm-6, 84+(controls * 70)), 2)
for c in range(0, 9): # draw the pot controls
drawPots(c)
pygame.display.update()
097.
098. def drawPots(ch):
099.     sX = padXm+10
100.     pygame.draw.rect(screen, black, (sX, 46+
(ch * 70), 66, 48), 0)
101.     pygame.draw.line(screen, (0, 180, 0), (sX, 47+
(ch * 70)), (sX+(volume[ch]/2), 47+(ch * 70)), 2)
102.     pygame.draw.line(screen, (180, 0, 0), (sX, 57+
(ch * 70)), (sX+(velocity[ch]/2), 57+(ch * 70)), 2)
103.     pygame.draw.line(screen, (0, 180, 180), (sX, 67+
(ch * 70)), (sX+64, 67+(ch * 70)), 2)
104.     pygame.draw.line(screen, (0, 0, 180), (sX, 67+
(ch * 70)), (sX+(pan[ch]/2), 67+(ch * 70)), 2)
105.     pygame.draw.line(screen, (80, 80, 80), (sX, 77+
(ch * 70)), (sX+(reverb[ch]/2), 77+(ch * 70)), 2)
106.
107. def drawWords(words, x, y, col, backCol) :
108.     textSurface = font.render(words, True, col,
backCol)
109.     textRect = textSurface.get_rect()
110.     textRect.right = x
111.     textRect.top = y
112.     screen.blit(textSurface, textRect)
113.     return textRect
114.
115. def readPots():
116.     for i in range(0, 4):
117.         adc = spi.xfer2([1, (8+i)<<4, 0]) # request channel
118.         reading = (adc[1] & 3)<<8 | adc[2]
119.         # join two bytes together
120.         if abs(reading - potValue[i]) > 8:
121.             potValue[i] = reading
122.             updatePots(i, reading>>3)
123.
124. def updatePots(num, value):
125.     ch = controls # value of channel we want to change
126.     if num == 0:
127.         volume[controls] = value

```

Language

>PYTHON 3

DOWNLOAD:
magpi.cc/1NqJmV
PROJECT
VIDEOS
 Check out Mike's
 Bakery videos at:
magpi.cc/1NqJnTz

```

136.     midiout.send_message([0xB0 |
137.     15-ch,0x07,volume[ch]]) # set volume
138.     if num == 1:
139.         velocity[controls] = value
140.     if num == 2:
141.         pan[controls] = value
142.         midiout.send_message([0xB0 |
143.         15-ch,0x0A,pan[ch]]) # set pan
144.     if num == 3:
145.         reverb[controls] = value
146.         midiout.send_message([0xB0 |
147.         15-ch,0x5B,reverb[ch]]) # set reverb channel
148.         drawPots(controls)
149.         pygame.display.update()
150.
151. def loadResource():
152.     global iNames,spi
153.     nameF = open("percussion.txt","r")
154.     iNames = []
155.     for i in nameF.readlines():
156.         n = i[:-1] # remove CR at end of name
157.         iNames.append(n)
158.     nameF.close()
159.     spi = spidev.SpiDev()
160.     spi.open(0,0)
161.     spi.max_speed_hz=1000000
162.
163. def initMIDI():
164.     available_ports = midiout.get_ports()
165.     print("MIDI ports available:-")
166.     for i in range(0,len(available_ports)):
167.         print(i,available_ports[i])
168.     if available_ports:
169.         midiout.open_port(1)
170.     else:
171.         midiout.open_virtual_port("My virtual
172.         output")
173.     for ch in range(7,16): # set up channels
174.         midiout.send_message([0xB0 | ch,0x07,
175.         volume[15-ch]]) # set volume
176.         midiout.send_message([0xB0 | ch,0x0A,
177.         pan[15-ch]]) # set pan
178.         midiout.send_message([0xB0 | ch,0x5B,
179.         reverb[15-ch]]) # set reverb channel
180.         midiout.send_message([0xB0 | ch,0x00,0x78])
181.         #set drum bank
182.         midiout.send_message([0xC0 | ch,0x00]
183.         # set instrument
184.         midiout.send_message([0xB0 | 7,0x0C,127])
185.         # set global reverb
186.
187. def createMatrix(): # create variables
188.     global matrixRect, matrixCont, volume, velocity,
189.     pan, reverb
190.     matrixRect = [] ; matrixCont = []
191.     rowSq = [] ; cont = []
192.     for row in range(0,9):
193.         t = [] ; c = [] # blank row and contents list
194.         for sq in range (15,-1,-1):
195.             t.append(pygame.Rect(
196.             (padXm-60-(50*sq),40+(row * 70),46,46)))
197.             c.append(0)
198.             matrixRect.append(t) ; matrixCont.append(c)
199.         volume = [ 127-c*8 for c in range(0,9) ]
200.         # channel volume
201.         velocity = [ 120-c*8 for c in range(0,9) ]
202.         # striking strength
203.         pan = [ 64 for c in range(0,9) ]
204.         # position in stereo field
205.         reverb = [ 127-(c*10) for c in range(0,9) ]
206.         # off by default
207.
208. def clearPads():
209.     global matrixCont,step,running
210.     for row in range(0,9):
211.         for sq in range(0,15):
212.             matrixCont[row][sq] = 0
213.     running = False
214.     step = 0
215.     drawScreen()
216.
217. def randomSetup():
218.     clearPads()
219.     for row in range(0,9):
220.         for sq in range(0,15):
221.             if random.randint(0,100) > 90 :
222.                 # random chance 10%
223.                 matrixCont[row][sq] = 1
224.         drawScreen()
225.
226. def setBPM(inc):
227.     global stepTime,bpm
228.     bpm +=inc
229.     stepTime = 1/(bpm / 60)
230.     drawControls()
231.
232. def runTk():
233.     global master
234.     master = Tk()
235.     menubar = Menu(master)
236.     menu = AutoBreakMenu(menubar, tearoff=0)
237.     fillMenu(menu)
238.     menubar.add_cascade(label="Instrument",
239.     menu=menu)
240.     mouse = PyMouse()
241.     x = mouse.position()[0]
242.     # move menu to mouse position
243.     y = mouse.position()[1]
244.     master.config(menu=menubar)
245.     master.geometry('%dx%d+%d+%d' % (78,0,x-8,y-46))
246.     mainloop() # run drop down menu
247.
248. def clicked(n): # instrument is chosen from menu
249.     global instNumber

```

```

230.     instNumber[insToChange] = n
231.     master.destroy() # remove menu window
232.
233. def handleMouse(pos): # look at mouse down
234.     global insToChange, running
235.     #print(pos)
236.     if pos[0] > 184 : # look at triggers
237.         for row in range(0,9):
238.             for place in range(0,16):
239.                 if matrixRect[row][place].collidepoint(pos):
240.                     #print("click in pad",row,place)
241.                     matrixCont[row][place] ^= 1 # toggle pad
242.                     drawPads()
243.                     pygame.display.update()
244.     else:
245.         for i in range(0,9):
# look at instrument rectangles
246.             if instRect[i].collidepoint(pos):
247.                 insToChange = i
248.                 pygame.draw.rect(screen,(128,8,8),
instRect[i],2)
249.                 pygame.display.update()
250.                 return
251.             if startRect.collidepoint(pos):
252.                 running = True
253.             if stopRect.collidepoint(pos):
254.                 running = False
255.
256. def handleMouseUp(pos): # look at mouse up
257.     if pos[0] < 184: # instruments and controls
258.         for i in range(0,9):
# look at instrument rectangles
259.             if instRect[i].collidepoint(pos):
260.                 runTk() # launch the instrument menu
261.                 drawScreen()
262.
263. def terminate(): # close down the program
264.     global midiout
265.     print ("Closing down")
266.     del midiout
267.     pygame.quit() # close pygame
268.     os._exit(1)
269.
270. def checkForEvent(): # handle events
271.     global step,controls,showControls,beat
272.     event = pygame.event.poll()
273.     if event.type == pygame.QUIT :
274.         terminate()
275.     if event.type == pygame.KEYDOWN :
276.         if event.key == pygame.K_ESCAPE :
277.             terminate()
278.         if event.key == pygame.K_c: # clear pads
279.             clearPads()
280.         if event.key == pygame.K_r: # reset sequence
281.             if not running:
282.                 drawLeds(0)
283.                 pygame.display.update()
284.                 step = -1
285.             if event.key == pygame.K_i: # inspiration
286.                 randomSetup()
287.             if event.key == pygame.K_EQUALS: # increment bpm
288.                 setBPM(10)
289.             if event.key == pygame.K_MINUS: # decrement bpm
290.                 setBPM(-10)
291.             if event.key == pygame.K_w: # whole beat
292.                 beat = 4 ; drawLeds(step)
293.                 pygame.display.update()
294.             if event.key == pygame.K_h: # half beat
295.                 beat = 8 ; drawLeds(step)
296.                 pygame.display.update()
297.             if event.key == pygame.K_q: # quarter beat
298.                 beat = 16 ; drawLeds(step)
299.                 pygame.display.update()
300.             if event.key >= pygame.K_1 and event.key <=
pygame.K_9: # set control channel
301.                 controls = int(event.key - pygame.K_0)-1
302.                 showControls = True ; setBPM(0)
303.             if event.key == pygame.K_0:
# cancel control channel
304.                 showControls = False ; setBPM(0)
305.
306.             if event.type == pygame.MOUSEBUTTONDOWN :
307.                 handleMouse(pygame.mouse.get_pos())
308.             if event.type == pygame.MOUSEBUTTONUP :
309.                 handleMouseUp(pygame.mouse.get_pos())
310.
311. def fillMenu(menu):
312.     for i in range(len(iNames)):
313.         menu.add_command(label=iNames[i],
command=functools.partial(clicked,i))
314.         menu.add_command(label="Exit", command=functools.
partial(clicked,-1))
315.
316. class AutoBreakMenu(Menu):
317.     MAX_ENTRIES = 21
318.     def add(self, itemType, cnf={}, **kw):
319.         entryIndex = 1 + (self.index(END) or 0)
320.         if entryIndex % AutoBreakMenu.MAX_ENTRIES == 0:
321.             cnf.update(kw)
322.             cnf['columnbreak'] = 1
323.             kw = {}
324.         return Menu.add(self, itemType, cnf, **kw)
325.
326. # Main program logic:
327. if __name__ == '__main__':
328.     main()

```

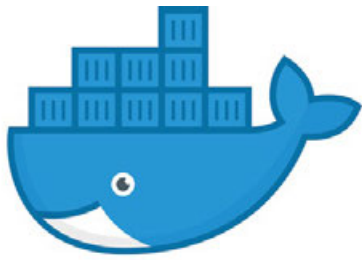

docker



MAGDALENA JADACH

Magda is former journalist, now a Software Developer at the Raspberry Pi Foundation, electronics enthusiast, a foodie, and an advocate for diversity in tech. She's also Bartek's wife and mum of Kazik the Dinosaur.
twitter.com/magda_jadach



BARTŁOMIEJ RUTKOWSKI

Bartek is a DevOps consultant specialising in Docker, Kubernetes, and cloud architecture. Programmer, FreeBSD developer, Magda's husband, and dad of Kazik the Alien.
github.com/bartekrutkowski

You'll Need

- > Wireless internet access
- > Another computer
- > Etcher app etcher.io
- > HypriotOS image magpi.cc/uaOHYS

INSTALL PLEX WITH DOCKER ON RASPBERRY PI

Learn how to simplify application deployment with Docker containers and HypriotOS by installing a Plex server

No operating system is very useful to its users if they can't run applications on it, and so its popularity largely depends on a rich application ecosystem. However, there are plenty of different operating systems, even for the Raspberry Pi, and often the application installation process is different on each of them. It becomes a serious problem for their users by increasing the

entry barrier and for developers who now have to prepare their applications for many operating systems. Docker containers make things easier, providing a unified installation method. Today we'll learn what containers and Docker are and how to use them.

What is Docker?

Before Docker became hugely popular, almost every operating system had its own means of installing applications. This resulted in users, developers, and businesses deploying applications to deal with every OS independently, requiring additional hours of reading tutorials, writing deployment documents and automation, and testing and debugging installation processes on different OSes.

In 2013 the dotCloud company released a piece of software called Docker, allowing the creation of packaged applications that were easy to run using the same steps on every system with Docker. If you are an OS user, you can try many new operating systems and run your favourite applications on them easily, without learning the installation intricacies of every one of them. If you are a software developer, you can stop worrying about all possible OSes and instead focus on developing your application and providing only one installation process for it, using Docker. And if you are a company, you can ease the transition

Figure 1 This is how the user-data file should look after you uncomment WiFi-related lines. Be careful to only remove the '#' characters!

```

42
43 ## WiFi connect to HotSpot
44 ## - use 'wpa_passphrase SSID PASSWORD' to encrypt the psk
45 write_files:
46 - content: |
47   allow-hotplug wlan0
48   iface wlan0 inet dhcp
49   wpa-conf /etc/wpa_supplicant/wpa_supplicant.conf
50   iface default inet dhcp
51   path: /etc/network/interfaces.d/wlan0
52 - content: |
53   ctrl_interface=DIR=/var/run/wpa_supplicant GROUP=netdev
54   update_config=1
55   network={
56     ssid="YOUR_WIFI_SSID"
57     psk="YOUR_WIFI_PASSWORD"
58     proto=RSN
59     key_mgmt=WPA-PSK
60     pairwise=CCMP
61     auth_alg=OPEN
62   }
63   path: /etc/wpa_supplicant/wpa_supplicant.conf
64
65 # These commands will be ran once on first boot only
66 runcmd:
67 # Pickup the hostname changes
68 - 'systemctl restart avahi-daemon'
69
70 # Activate WiFi interface
71 - 'ifup wlan0'
72

```

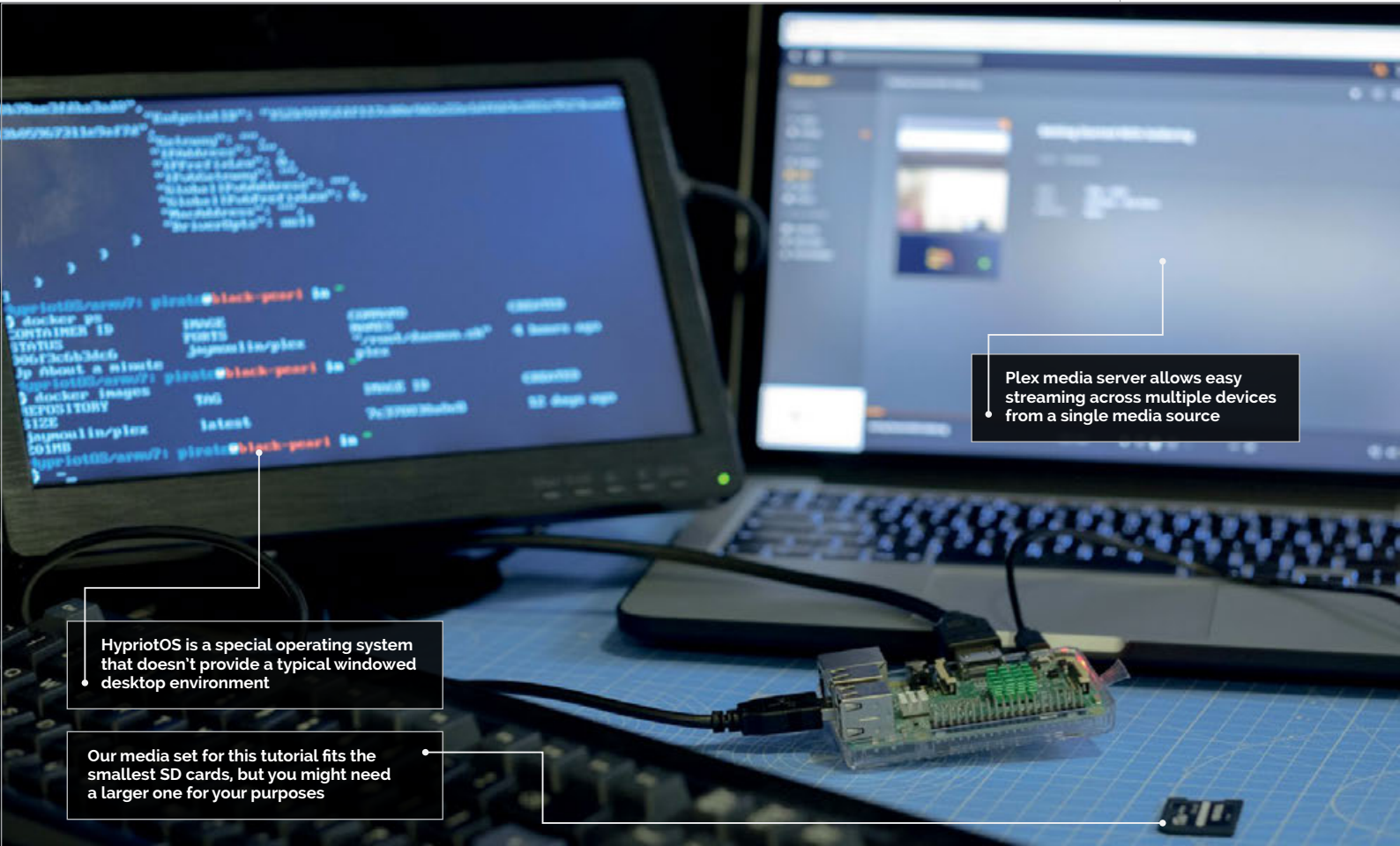
of your application from developers' environments onto production servers, saving time and avoiding additional issues.

Docker containers are simply processes running on a Linux system that are launched from container images. Container images are archives of the application files (like HTML and CSS or Node.js code), any binaries and libraries required by the application (like NGINX web server or a MySQL database), and everything else required by the application (configuration, network settings, and other metadata).

These container images, also called 'containers' for short, can be shared between users and developers in the form of a single archive file and can even be published on an indexing website, **hub.docker.com**, where anyone can browse for and download containers to use on their computer with Docker.

Where to start

First, we need an operating system to run Docker on. Docker can be installed in Raspbian, but it is easier to use HyprIoTOS, which is tailored for running Docker on Raspberry Pi and comes with everything installed and ready to use.

From magpi.cc/uaOHYS, download the latest HyprIoTOS image (at the time of writing,

hypriotos-rpi-v1.7.1.img.zip) and burn it to your SD card with Etcher. When the SD card is ready, we need to edit two files on the boot partition to ensure our Raspberry Pi will have internet access.

“ It is easier to use HyprIoTOS, which is tailored for running Docker on Raspberry Pi ”

In the file **config.txt**, change the line **enable_uart=1** (line number 3) to **enable_uart=0**, save and close the file. Next, in the file **user-data**, find a commented block that starts with the line **#write_files:** and ends with the line **path: /etc/wpa_supplicant/wpa_supplicant.conf** (lines 45-63) and uncomment them by removing the **#** character prepping each of these lines, so that they look as shown in **Figure 1**.

In that block, you need to replace the **YOUR_WIFI_SSID** string with the name of your wireless network. You should also replace the **YOUR_WIFI_PASSWORD** string with your wireless network's password. Then, at the bottom of that file, find a line **# - 'ifup wlan0'** and uncomment it as well. Save and close the file.

WIRELESS CONFIGURATION ON HYPRIOTOS

Be careful when editing the **user-data** file: even a single extra (or missing) space character can cause problems and you will have to flash the SD card from scratch.

```

/home/pirate?
r@C64 ~ /tmp ssh pirate@192.168.168.135
The authenticity of host '192.168.168.135 (192.168.168.135)' can't be established.
ECDSA key fingerprint is SHA256:nHsqoSMKY64tCjvG276+p+gsMqV8EHKWVWrao/9gi4.
Are you sure you want to continue connecting (yes/no)? yes
Warning: Permanently added '192.168.168.135' (ECDSA) to the list of known hosts.
pirate@192.168.168.135's password:

HyprIoTOS (Debian GNU/Linux 8)

The programs included with the Debian GNU/Linux system are free software;
the exact distribution terms for each program are described in the
individual files in /usr/share/doc/*/copyright.

Debian GNU/Linux comes with ABSOLUTELY NO WARRANTY, to the extent
permitted by applicable law.
Last login: Sun Mar  4 15:22:22 2018 from c64
HyprIoTOS/armv7: pirate@black-pearl in ~
$ id
uid=1000(pirate) gid=1000(pirate) groups=1000(pirate),44(video),100(users),999(docker)
HyprIoTOS/armv7: pirate@black-pearl in ~
$

```

Figure 2 Using SSH to log into the Raspberry running HyprIoTOS over the network. You can do that or just use the keyboard for the entire tutorial

FINDING DOCKER IMAGES FOR PI

The Raspberry Pi's CPU architecture is ARM instead of x86. Thus, Docker images you can use are built specifically for it. Look for 'rpi'-prefixed images whilst browsing hub.docker.com.

That's all there is to it: you can now place the SD card into your Raspberry Pi, turn it on, and watch it booting HyprIoTOS.

How to use Docker

Now that we have the system to run Docker on, we need to ensure that it's running properly and has internet access. On your screen you'll see a console login prompt, where you should use the default HyprIoTOS user name **pirate** and the password **hypriot** to log into the console. You will then be greeted with the message shown in **Figure 2**.

Congratulations, you're in! Now, to check if you have internet connectivity, type **sudo ping raspberrypi.org -c 1** in the Terminal; if you have a working wireless connection, the output should resemble that in **Figure 3**.

“ Congratulations, you're in!
Now, to check if you have internet connectivity ”

BURNING SD CARD WITH ETCHER

Copying operating system image files onto a SD card is an essential part of getting started with a Raspberry Pi. The Etcher app makes it easy: magpi.cc/zfZkyJD

To find out the IP address of your Raspberry Pi, enter **host black-pearl** and you will get an output like **black-pearl has address 192.168.168.135**, where the 'black-pearl' is the default name of HyprIoTOS system and the '192.168.168.135' is the IP address of your Raspberry Pi. Make a note of it, as we will use it later. If you want, you may now use the user name, password, and IP address to SSH into the Pi and continue the rest of this tutorial using an SSH session from another computer, but that is entirely optional.

Now you've verified your network connection and IP address, the last thing that needs to be done is to check if Docker is installed and running. To do so, enter **systemctl status docker** and in the output there should be a line that says **Active: active**

(**running**), as shown in **Figure 3**. It means that Docker is installed and running, ready for you to have fun with!

If your output differs or you are getting any error messages, it means your Pi didn't connect to the wireless network properly. In that case, repeat the procedure of flashing your SD card and pay attention to editing the files exactly as described.

Do cool things with Docker

Every coding tutorial on earth starts with a 'Hello world!' example and we have one like that as well. Type **docker run hello-world** and at the top of the output you will see a line reading **Hello from Docker!**

What just happened? We've instructed Docker to run a program in a container called 'hello-world' and, behind the scenes, Docker checked that we haven't got such a container image downloaded yet, so it pulled it from **hub.docker.org** and ran a container based on it. The application in this container is a very simple one and all it does is print the message you can see in your Terminal and then exits, terminating the container it ran in.

Let's dig deeper into Docker. Type in **docker pull stealthizer/rpi-whalesay** (this may take a while depending on your network speed). Earlier we started with **docker run**; it's a shortcut doing a lot of things automatically, but this time we have asked Docker to download a container called **rpi-whalesay** from user account **stealthizer** on **hub.docker.com** and watched Docker pulling that image and unpacking it. Now the image is available, so we can use it by typing **docker run stealthizer/rpi-whalesay "I love Raspberry Pi!"**. In the output you will see a picture of a whale shouting that it loves Raspberry Pi.

That command ordered Docker to run an application from the container image of **stealthizer/rpi-whalesay** with a text string parameter. Docker noticed the image is already available, so it didn't have to pull it and it passed our text string to the container. The application inside generated the picture with the text

```

/home/pirate?
HyprIoTOS/armv7: pirate@black-pearl in ~
$ sudo ping raspberrypi.org -c 1
PING raspberrypi.org (93.93.128.230) 56(84) bytes of data:
64 bytes from 93.93.128.230: icmp_seq=1 ttl=55 time=12.6 ms

--- raspberrypi.org ping statistics ---
1 packets transmitted, 1 received, 0% packet loss, time 0ms
rtt min/avg/max/mdev = 12.672/12.672/12.672/0.000 ms
HyprIoTOS/armv7: pirate@black-pearl in ~
$ host black-pearl
black-pearl has address 192.168.168.135
HyprIoTOS/armv7: pirate@black-pearl in ~
$ systemctl status docker
* docker.service - Docker Application Container Engine
   Loaded: loaded (/lib/systemd/system/docker.service; enabled)
   Active: active (running) since Thu 2014-07-03 18:46:31 UTC; 3 years 8 months ago
     Docs: https://docs.docker.com
   Main PID: 371 (dockerd)
   CGroup: /system.slice/docker.service
           └─371 /usr/bin/dockerd -H fd://
               └─413 docker-containerd -l unix:///var/run/docker/libcontainerd/do...
HyprIoTOS/armv7: pirate@black-pearl in ~
$ docker ps
CONTAINER ID        IMAGE               COMMAND             CREATED
STATUS            PORTS              NAMES
HyprIoTOS/armv7: pirate@black-pearl in ~
$

```

Figure 3 Testing internet access, discovering Raspberry's IP address, and checking if Docker is ready

```

/home/pirate?
HyprIoT05/armv7: pirate@black-pearl in ~
$ docker pull jaymoulin/plex
Using default tag: latest
latest: Pulling from jaymoulin/plex
47a3e1ab5857: Pull complete
89a21c9fc6fb: Pull complete
c8886317ca6c: Pull complete
929cf8aa8f2f: Pull complete
6283e2ec5f89: Pull complete
a78a7ed7e2e6: Pull complete
6a7c9240e487: Pull complete
Digest: sha256:68843f2897ec83b152bce5b63416b8319278ec7abbaa8b6a363cd8a6d7af9b91f
Status: Downloaded newer image for jaymoulin/plex:latest
HyprIoT05/armv7: pirate@black-pearl in ~
$ docker run -d --restart=always --name=plex -v=/media:/media --net=host jaymoulin/plex
086f3ceb3dc6f1abcd21840a218a9639d96416880ce8794998aacfaed29cbe82
HyprIoT05/armv7: pirate@black-pearl in ~
$ docker ps
CONTAINER ID        IMAGE               COMMAND             CREATED
STATUS            PORTS              NAMES
086f3ceb3dc6      jaymoulin/plex    */root/daemon.sh*  20 seconds ago
Up 12 seconds
HyprIoT05/armv7: pirate@black-pearl in ~
$
    
```

Figure 4 Downloading the Plex image and starting a Docker container takes just two commands!

and exited. Give it a try and have some fun changing the quoted text to something else.

Do something useful with Docker

Docker simplifies applications and it may seem that for things we've tried earlier it doesn't make much of a difference. Now we're going to do something really useful that would be very complicated otherwise: set up a Plex media server, which lets you stream your movies, music, and pictures anywhere on any device.

First, pull the Plex image with `docker pull jaymoulin/plex`. Then download a multimedia set prepared for this tutorial: `wget https://magpi.cc/plex-media -O /tmp/plex-media` and unpack with `sudo tar xvzf /tmp/plex-media -C /media`. As a last step, run the Plex container: `docker run -d --restart=always --name=plex -v=/media:/media --net=host jaymoulin/plex`.

That command performs a series of events. First, it orders Docker to run the application in background with a `-d` flag, then restart it automatically if it exists with a `--restart=always` flag. It then assigns the container name with `--name=plex` instead of a random one, connects the `/media` folder on the Raspberry file system to a folder of the same name inside the container with `-v=/media:/media`, sets the container network to use Raspberry's IP address with `--net=host`, and finally specifies the `jaymoulin/plex` container image to use. Check if the container is running fine with the `docker ps` command and you should see output like that in Figure 4.

Plex is now installed and running, so you can configure it. Open `http://[YOUR_IP_ADDRESS]:32400/web/index.html` in a browser, where you replace `YOUR_IP_ADDRESS` with your Raspberry Pi's IP address discovered earlier (e.g., `http://192.168.168.135:32400/web/index.html`).

The Plex setup screen will open, where it will ask you to create an account. Skip this by clicking on the 'What's this?' link in the bottom-right corner, then click 'Skip and accept limited functionality' at the bottom of the next screen. Click 'Got it!' on the next screen and close the 'Plex pass' pop-up. On the

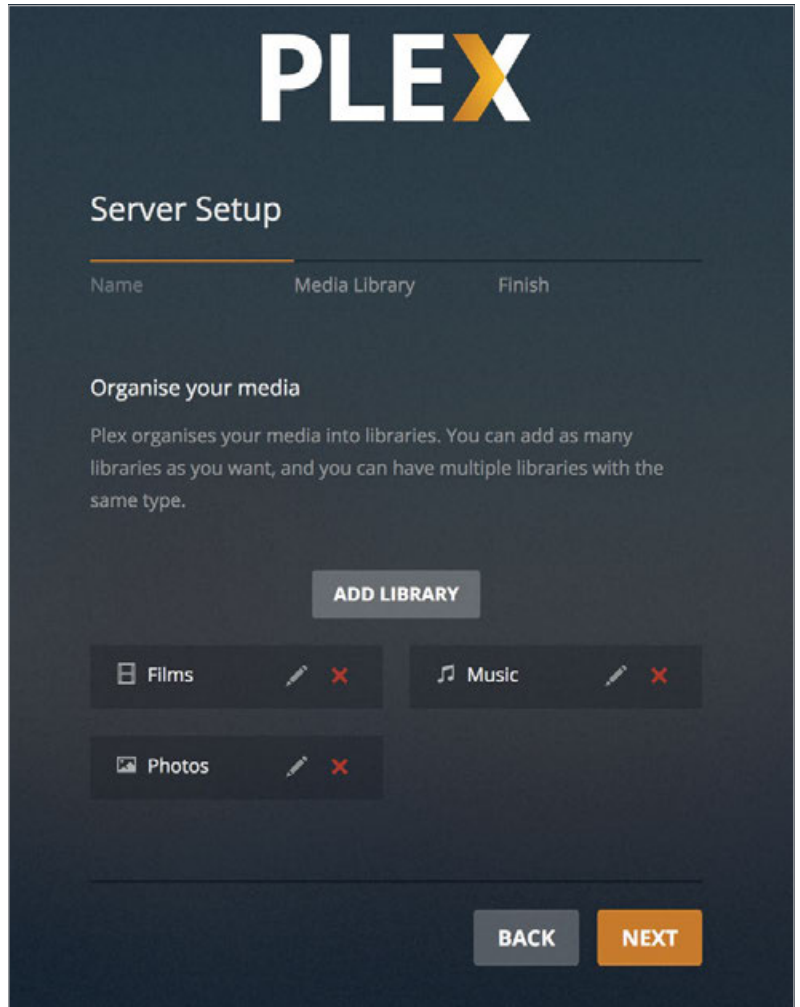

Figure 5 Setting up Plex with media libraries; 'Films', 'Music', and 'Photos' are added and ready to use

following screen with 'Plex Server Setup', click Next to go to the media libraries configurator.

Press the 'Add library' button (Figure 5) and pick the Films library type, then Next, and then 'Browse for media folder'. Click the `/media` directory and select the `movies` folder inside it, then click Add and then 'Add library'. Repeat this with a Music and Photos library, pointing towards music and pictures directories respectively.

After configuring the libraries, click Next and Done on the following screen, and the Plex dashboard screen will load. Click Settings on the left-hand side menu, find the Library menu and tick 'Update my library automatically' and 'Update my library periodically' options, then click 'Save changes'. Now you are all set up! Click the home icon in the top-left corner to get back to the dashboard.

You can now watch media files from these libraries from a browser on any computer using the same wireless network as your Raspberry Pi with Docker. There are Plex applications available for tablets and smartphones for streaming on mobile devices too!

There is much more to containers, Docker, and HyprIoT. To learn more, and even how to build your own containers, check out magpi.cc/CmofXu and magpi.cc/vwohdL. Happy dockerising!

ACCESSING YOUR RASPBERRY PI REMOTELY

You can access the Raspberry Pi remotely from another computer using SSH. How to do that depends on your operating system, but you can find more information about it here: magpi.cc/1GULmTr



JEROEN PETERS

Jeroen spends his day back-end developing for Yourhosting and loves to create open-source projects (mostly) by night. magpi.cc/MuQCY

KEEP COOL WITH A PI-POWERED FAN

You'll Need

- > 3.5-inch touchscreen and case magpi.cc/bpWaTO
- > DHT22 sensor (on PCB) magpi.cc/rVJjfJ
- > USB fan magpi.cc/gTcRve

MAKE IT EVEN CHEAPER

Although the DHT22 and mini table-fan are relatively cheap, you can also use a DHT11 and a simple USB fan.

Sitting behind a desk can be very stressful at times, but with some clever code and a USB fan, you'll be able to keep your cool

Nothing is as personal as the level of comfort someone feels. In shared office spaces it's almost impossible to create a climate in which everyone feels comfortable, especially when these shared spaces are large. With about 40–50 people in a room, we can't all be happy. We've put together some components, both hardware and software, to keep us cool. Here's how you can do the same...

>STEP-01 Wire up the sensor

First things first: this project is all about monitoring temperature, so we need to attach the sensor. It's important to do this before attaching the display. Wire

up the temperature sensor using the PiFan wiring diagram in **Figure 1**.

>STEP-02 Attach the other components

After you've attached the sensor, mount the display on the Raspberry Pi. It slots nicely on top of the GPIO pins, so this should be easy. Now you can build the acrylic case around it to support the display and protect your Raspberry Pi. Of course, you should make sure the sensor stays on the outside of the case. After completing the case, plug the USB fan into your Raspberry Pi. If your USB fan has a power switch, hit it to make sure it works.

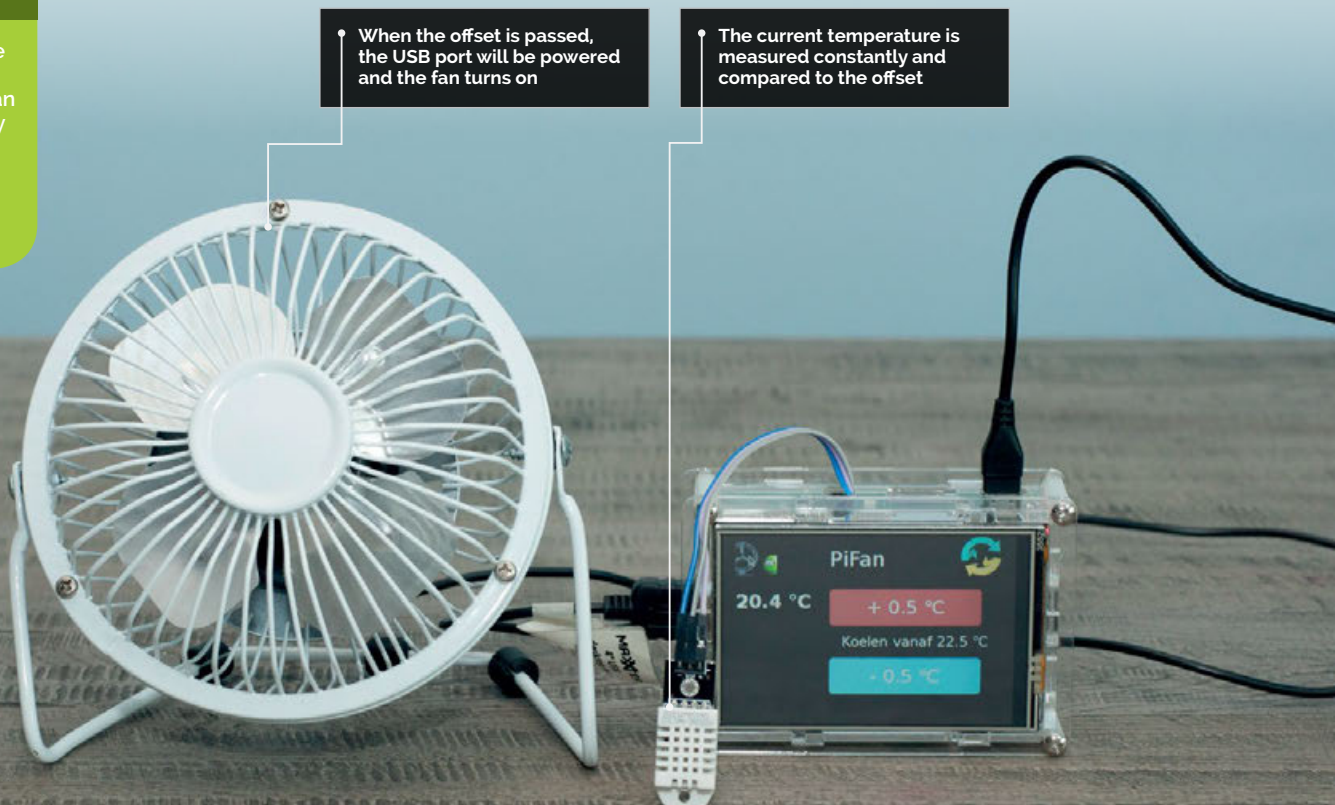

>STEP-03

Set up the OS and display

The manufacturer of this screen has an image of Raspbian (with Raspberry Pi Desktop) available, which has the display driver built in. You can download it to burn to an SD card from magpi.cc/aNmzpT. Follow our guide to burn SD cards here: magpi.cc/2fZkyJD.

If you want to install the driver manually, or have another type of screen, that's no problem. Just be sure to use Raspbian with the Raspberry Pi Desktop so that Chromium is available.

>STEP-04

Download the software

Open the Terminal (or dial in with SSH from another computer) to install and download all of the software. We'll start with the prerequisites. Install them with the command:

```
sudo apt-get install nginx-light supervisor
git build-essential python-dev python-pip
```

Also install the Python framework Falcon by executing:

```
sudo pip install falcon==1.0.0
```

Now clone and install the sensor module driver:

```
git clone https://github.com/adafruit/
Adafruit_Python_DHT.git /tmp/dht
cd /tmp/dht
sudo python setup.py install
```

Now clone the PiFan GitHub repo with the following command:

```
git clone https://github.com/
jeroenpeters1986/pifan.git /home/pi/pifan
```

All software needed will now be on the Raspberry Pi.

>STEP-05

Configure the software

We now need to configure the software we just downloaded. The following commands will configure the web server and create three processes that will be supervised (so they are always available):

```
sudo rm /etc/nginx/sites-enabled/default
cd /home/pi/pifan/config
sudo cp nginx-sites-enabled-default
/etc/nginx/sites-enabled/default
sudo cp supervisor-* /etc/supervisor/conf.d/
```

The last requirement is to autostart Chromium with the interface. Create the **autostart** folder and change directory to it:

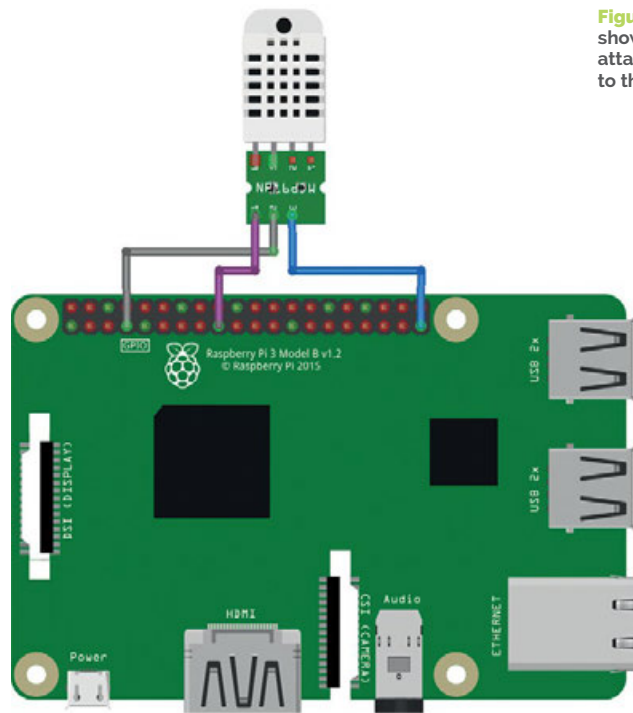

Figure 1 This diagram shows you how to attach the sensor to the GPIO header

```
mkdir -p /home/pi/.config/autostart
cd /home/pi/.config/autostart
```

Within this directory, create a file called **AutoChromium.desktop**:

```
sudo nano AutoChromium.desktop
```

Then type in the following:

```
[Desktop Entry]
Type=Application
Exec=/usr/bin/chromium-browser --noerrdialogs
--disable-session-crashed-bubble
--disable-infobars --disable-translate
--kiosk http://127.0.0.1
Hidden=false
X-GNOME-Autostart-enabled=true
Name=AutoChromium
```

Now save the file and reboot the Raspberry Pi, so you can see if it worked.

>STEP-06

Customise your PiFan

If you know a thing or two about HTML and CSS, and a little bit about JavaScript, you can customise the interface yourself! There is only one HTML file you can edit. In there, you'll also see the JavaScript and CSS references. To customise the PiFan touch interface, edit the **/home/pi/pifan/webinterface/index.html** file. Once you have made changes, tap the refresh button on the top-right of your touchscreen to see your changes.

SHUT IT DOWN CORRECTLY

Tap the fan-guy in the top-left and the PiFan text is highlighted. Tap this text to engage a proper shutdown.



STEVE MARTIN

Steve has worked in the software industry for 25 years and runs a Code Club at Longlevens Library in Gloucestershire. twitter.com/ox90_Bug

You'll Need

- > Minecraft Pi
- > An idea for a great house
- > A keyboard

BUILD A HOUSE IN MINECRAFT USING PYTHON

Get creative with Minecraft on the Raspberry Pi and learn to program in Python by building your own house

Writing programs that create things in Minecraft is not only a great way to learn how to code, but it also means that you have a program that you can run again and again to make as many copies of your design as you want. You never need to worry about your creation being destroyed by your brother or sister ever again when you can simply rerun your program and get it back. Whilst it might take a little longer to write the

program than to build one house, once finished you can build as many houses as you want.

Co-ordinates in Minecraft

Let's start with a review of the co-ordinate system that Minecraft uses to know where to place blocks. If you are already familiar with this, you can skip to the next section. Otherwise, read on.

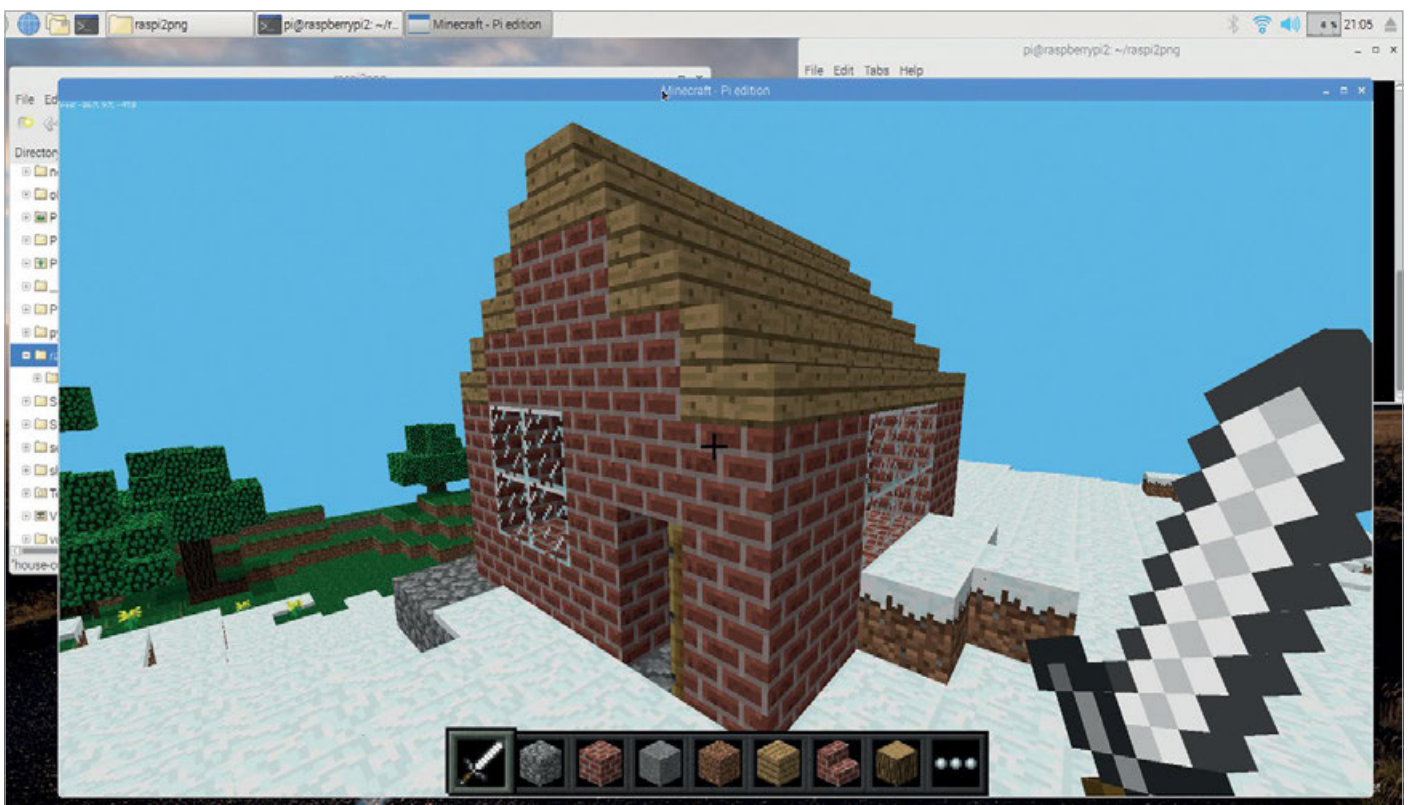

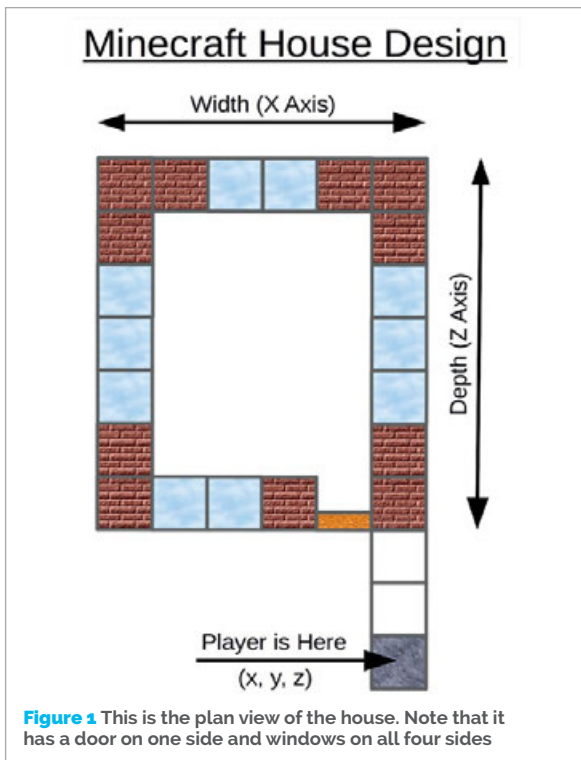

We will build our house close to where the Minecraft player is standing. This is a good idea when creating something in Minecraft with Python, as it saves us from having to walk around the Minecraft world to try to find our creation. Right, let's get coding.

Starting our program

Type in the code as you work through this tutorial. You can use any editor you like; we would suggest either Python 3 (IDLE) or Thonny Python IDE, both of which you can find on the Raspberry Pi menu under Programming. Start by selecting the File menu and creating a new file. Save the file with a name of your choice; it must end with '.py' so that the Raspberry Pi knows that it is a Python program.

It is important to enter the code exactly as it is shown in the listing (**house-complete.py**). Pay particular attention to both the spelling and capitalisation (upper- or lower-case letters) used. You may find that when you run your program the first time, it doesn't work. This is very common and just means there's a small error somewhere. The error message will give you a clue as to where the error is.

It is good practice to start all of your Python programs with the first line as shown in our listing. All other lines that start with a '#' are comments. These are ignored by Python, but they are a good way to remind us what the program is doing.

The two lines starting with **from** tell Python about the Minecraft API; this is a library that our program will be using to talk to Minecraft. The line starting **mc =** creates a connection between our Python program and the game. Then we get the player's location broken down into three variables: **x**, **y**, and **z**.

Building the shell of our house

To help us build our house, we define three variables that specify its **width**, **height**, and **depth**. Defining these variables makes it easy for us to change the size of our house later; it also makes the code easier to understand when we are setting the co-ordinates of the Minecraft bricks. For now, we suggest that you use the same values that we have; you can go back and

Figure 2 This initial shell of the house is already complete. Smash through one of the walls to make sure that the house is hollow inside

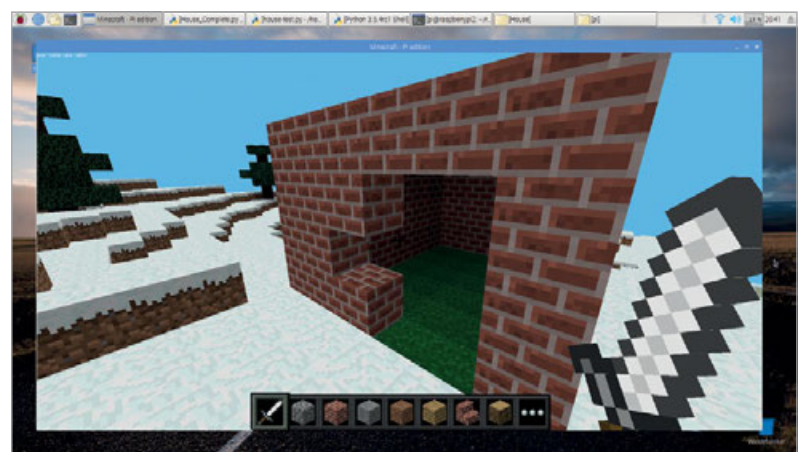

Minecraft shows us a three-dimensional (3D) view of the world. Imagine that the room you are in is in the Minecraft world and you want to describe your location within that room. You can do so with three numbers, as follows:

How far across the room you are. As you move from side to side, you change this number. We can consider this value to be our X co-ordinate.

How high off the ground you are. If you are upstairs, or if you jump, this value increases. We can consider this value to be our Y co-ordinate.

How far into the room you are. As you walk forwards or backwards, you change this number. We can consider this value to be our Z co-ordinate.

You might have done graphs in school with X going across the page and Y going up the page. Co-ordinates in Minecraft are very similar, except that we have an extra value, Z, for our third dimension. Don't worry if this still seems a little confusing: once we start to build our house, you will see how these three dimensions work in Minecraft.

Designing our house

It is a good idea to start with a rough design for our house. This will help us to work out the values for the coordinates when we are adding doors and windows to our house. You don't have to plan every detail of your house right away. It is always fun to enhance it once you have got the basic design written. **Figure 1** shows the plan view of the house design that we will be creating in this tutorial. Note that because this is a plan view, it only shows the X and Z co-ordinates; we can't see how high anything is. Hopefully you can imagine the house extending up from the page.

house-complete.py

```
#!/usr/bin/env python3
from mcpi.minecraft import Minecraft
from mcpi import block

# Connect to Minecraft
mc = Minecraft.create()

# Determine the Player's current position.
x,y,z = mc.player.getTilePos()

width = 5
height = 3
depth = 6

# Create a hollow shell made of bricks.
mc.setBlocks(x, y, z+3, x+width, y+height, z+3+depth, block.BRICK_BLOCK.id)
mc.setBlocks(x+1, y, z+4, x+width-1, y+height-1, z+2+depth, block.AIR.id)

# Set the floor.
mc.setBlocks(x-1, y-1, z+2, x+1+width, y-1, z+4+depth, block.COBBLESTONE.id)

# Add a Door.
mc.setBlock(x+1, y, z+3, block.DOOR_WOOD.id, 0)
mc.setBlock(x+1, y+1, z+3, block.DOOR_WOOD.id, 8)

# Add Windows.
mc.setBlocks(x+3, y+1, z+3, x+4, y+2, z+3, block.GLASS.id)
mc.setBlocks(x+2, y+1, z+3+depth, x+3, y+2, z+3+depth, block.GLASS.id)
mc.setBlocks(x, y+1, z+5, x, y+2, z+7, block.GLASS.id)
mc.setBlocks(x+width, y+1, z+5, x+width, y+2, z+7, block.GLASS.id)

# Add a Roof.
for i in range(int(width/2) + 1):
    mc.setBlocks(x+i, y+height+i, z+3, x+i, y+height+i, z+3+depth, block.STAIRS_WOOD.id, 0)
    mc.setBlocks(x+width-i, y+height+i, z+3, x+width-i, y+height+i, z+3+depth, block.STAIRS_WOOD.id, 1)
# Gable ends.
if (int(width/2) - i > 0):
    mc.setBlocks(x+1+i, y+height+i, z+3, x+width-i-1, y+height+i, z+3, block.BRICK_BLOCK.id, 0)
    mc.setBlocks(x+1+i, y+height+i, z+3+depth, x+width-i-1, y+height+i, z+3+depth, block.BRICK_BLOCK.id, 1)
```

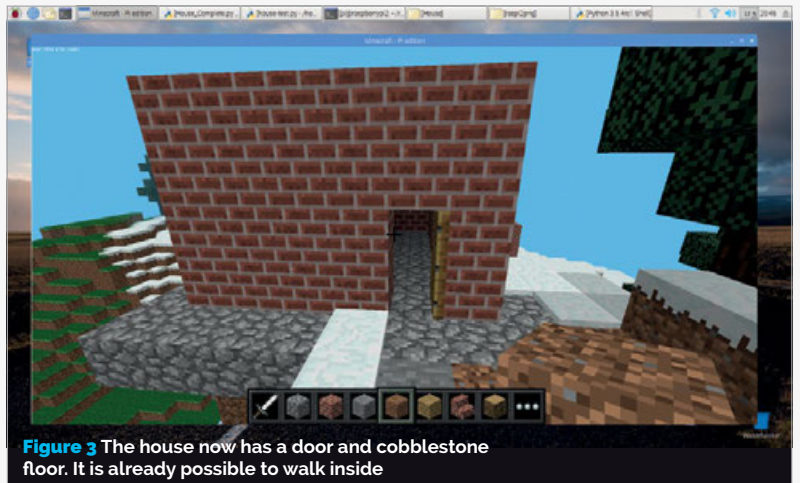

Figure 3 The house now has a door and cobblestone floor. It is already possible to walk inside

Language

>PYTHON 3

DOWNLOAD:
magpi.cc/orCLSD

change the values once the house is complete and you want to alter its design.

It's now time to start placing some bricks. We create the shell of our house with just two lines of code! These lines of code each use **setBlocks** to create a complete block of bricks. This function takes the following arguments:

```
setBlocks(x1, y1, z1, x2, y2, z2, block-id, data)
```

x1, y1, z1 are the co-ordinates of one corner of the block of bricks that we want to create; **x2, y2, z2** are the co-ordinates of the other corner. The **block-id** is the type of block that we want to use. Some blocks require a further **data** value; we will see that being used later, but it can be ignored for now.

We have to work out the values that we need to use in place of **x1, y1, z1, x2, y2, z2** for our walls. Note that what we want is a larger outer block made of bricks and then to fill it with a slightly smaller block of air blocks. Yes, in Minecraft even air is actually just another type of block.

Once you have typed in the two lines that create the shell of your house, you should run your program. Before doing so, you must have Minecraft running and displaying the contents of your world. Do not have a world loaded with things that you have created, as they may get destroyed by the house that we are building. Go to a clear area in the Minecraft world before running the program. When you run your program, check for any errors in the 'console' window and fix them before continuing trying to run it again until all the errors have been fixed.

You should see a block of bricks created, as shown in **Figure 2**. You may have to turn the player around in the Minecraft world before you can see your house.

Adding the floor and door

Now, let's make our house a bit more interesting. Add the lines for the floor and door. Note that the floor extends beyond the boundary of the wall of the house; can you see how we achieve this? Hint: look closely at how we calculate the x and z attributes as compared to when we created the house shell above. Also note that we use a value of **y-1** to create the floor below our feet.

Minecraft doors are two blocks high, so we have to create them in two parts. This is where we have to use the **data** argument. A value of **0** is used for the lower half of the door, and a value of **8** is used for the upper half (the part with the windows in it). These values will create an open door. If we add **4** to each of these values, a closed door will be created.

Run your program again to check that the floor and door are created (**Figure 3**). Before you do so, move to a new location in Minecraft to build the house away from the previous one. You will need to fix any errors. Even when your program runs without errors, check that the floor and door are positioned correctly. If they aren't then you will need to check the arguments to **setBlock** and **setBlocks** are exactly as shown in the listing.

Adding windows

Hopefully you will agree that your house is beginning to take shape. Now let's add some windows. Looking at the plan for our house, we can see that there is a window on each side; see if you can follow along. Add the four lines of code, one for each window.

Now you can move to yet another location and run the program again; you should have a window on each side of the house (**Figure 4**). Now our house is starting to look pretty good!

Adding a roof

The final stage is to add a roof to the house. To do this we are going to use wooden stairs. We will do this inside a loop so that if you change the width of your house then more layers are added to the roof. Enter the rest of the code. Be careful with the indentation: we recommend using spaces and avoiding the use of tabs. After the **if** statement, you need to indent the code even further. We use four spaces for each indentation level, so after the line with **if** on it you will need eight spaces for the indent.

Since some of these code lines are lengthy and heavily indented, you may well find that the text wraps around as you reach the right-hand side of your editor window – don't worry about this. You will have to be careful to get those indents right, however.

Now run the complete program. Iron out any last bugs, then admire your house. Does it look how you expect? Can you make it better?

Customising your house

Now you can start to customise your house. It is a good idea to use 'Save As' to save a new version of your program so that you can keep different designs, or refer back to your previous program if you get to a point where you don't understand why it doesn't work.

Consider these changes:

- Change the size of your house.** Are you able also to move the door and windows so they stay in proportion?
- Change the materials used for the house.** An ice house placed in an area of snow would look really cool!
- Add a back door to your house.** Or make the front door a double-width door.

We hope that you have enjoyed writing this program to build a house. Now you can easily add a house to your Minecraft world whenever you want to, just by running this program.



Figure 4 The windows have been added on all four sides



BRIAN BEUKEN

Very old game programmer now teaching very young game programmers a lot of bad habits at Breda University of Applied Science in Breda NL.
scratchpadgames.net

CODING GAMES ON THE RASPBERRY PI IN C/C++ PART 04

You'll Need

- ▶ Code::Blocks
`sudo apt-get install codeblocks`
- ▶ STB
magpi.cc/2GCQe19
- ▶ A pretty picture; not too big

READ THE CODE

There are comments and descriptions in the code that explain what it is supposed to do.

If coding is about manipulating data, let's manipulate some data

The graphics in our game so far are nice, but a bit simple and fixed. Also, we only have one graphic. This can be easily fixed by making our CPU do what a CPU is designed to do, which makes our life a lot easier. We also need to try to make the creation and use of graphic objects easier and more flexible. Let's begin.

We mentioned last time that all programming is about manipulating data based on conditions or needs. Let's consider a possible need we have and think about how we can manipulate the data.

At the moment we move our squares based on values -1.0f to +1.0f on the x and y axes. This gives us a rather cumbersome way of working out their position on the screen; we can only really be sure of the centre 0,0 position and the edges. This is all because of the way our GPU thinks about the buffer it draws graphics in, called the clip space. For a GPU, it makes sense to use a value that represents a ratio of the size of its clip space buffer; for a human, though, we're much more comfortable with the idea

of Cartesian x-y co-ordinates, which represent pixels in that space.

Another slight issue is that our 'squares' are not actually square – they are rectangular. That's because our concept of -1.0f to +1.0f is considered to be a ratio of each axis of the clip space, which we set to be a rectangular size when we defined our screen sizes. Our images also use those ratios, so they become mini rectangles like the screen.

So it's clear we need to do something to turn these ratio values into simple pixel co-ordinates and get rid of this rectangular distortion.

We have to keep in mind that our GPU thinks in terms of clip space, so when it draws, it will need to use a clip space value. If 'we' want to use pixel co-ordinates, we have to transform them into ratios for the GPU to use.

So we have a need: we want to use pixel co-ordinates and turn them into clip-space ratios when the GPU wants to use them. There are actually two ways to do this. We can do it in our draw code before we send the position value to the shader, using quite a simple sequence of steps; or, even cooler, we can do it in the shader itself.

Which is best? Well that's a really good question, because both systems will work. Ideally, we want to make it happen on the shader, because shaders love doing maths. To begin with, let's do it on the CPU so we can be very sure about what is happening.

Time for maths!

There's no escaping the fact that manipulation of almost any data is maths, but it's usually very simple maths; if you know how to do basic arithmetic, you can accomplish a lot of things.



Figure 1 An array holds data or pointers to data

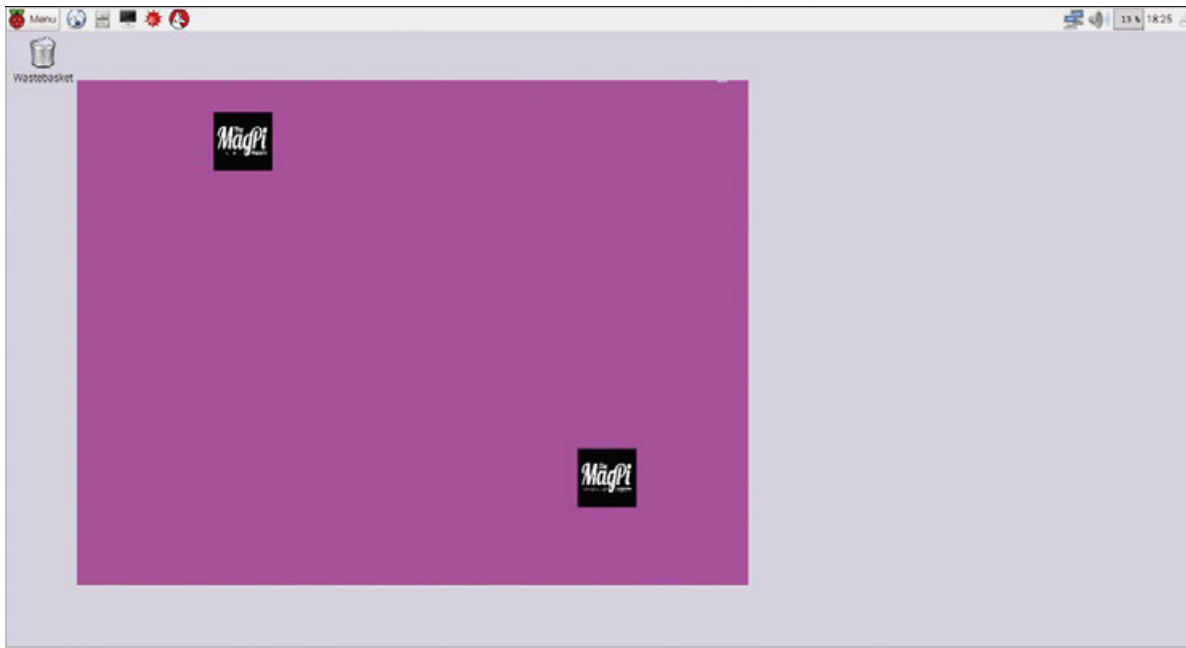

Language

> C++

NAME:
MagPiHelloTriangle.
cpp,
SimpleObj.h/cpp,
Game.h/cpp,
OGL.h/cpp

DOWNLOAD:
magpi.cc/PryrsN

Here, all we want to do is turn a pixel value that is easy for us to understand into a ratio that is easy for the GPU to understand. This is a case of using the pixel values and sizes we have and seeing them as fractions, which then become ratios. We have a slight complication since the clip screen uses co-ordinates between -1.0f and +1.0f, and we really want to remove negatives. However, we know the width and height of our screen, so in our update we can do this:

```
Pos[0] = ((Xpos-512) / 512);
Pos[1] = ((Ypos-384) / 384);
```

Subtracting half the screen height or width, and then dividing the result by that half value enables us to move our co-ordinate systems to a bottom-left position: 0,0.

Now we can code that in our draw function, and change our initialise and update systems to work on real pixel values instead of ratios. So, rather than test for -1.0f and +1.0f, test for 0 and SCREENWIDTH for the x direction, and 0 and SCREENHEIGHT for the y direction.

Try to make the changes in Lesson 3's code, use co-ordinates in your update code, and convert before the draw sends to the shader (you will also find it on the GitHub: magpi.cc/2suLVC2). You can see we are bouncing around still, but now we have a much easier-to-understand co-ordinate system which allows us to think in pixel terms rather than ratios. Our needs have been partially resolved; we still have our oblong shapes and another niggle: they're the wrong size!

How to make it better

To fix the oblong issue, we also need to change the ratio-based offsets that make up the triangles, and

Figure 2 Nice and square

here we run into a bit of a quandary. Yes, we can do it in our CPU code, but if we're trying to change data we send to the shader, wouldn't it be better if the shader changed the values?

Well, the answer is probably yes, but it does mean we need to make changes to our shader, and pass information that allows it to convert screen-based co-ordinates to ratios.

We know we pass information from code to the shader in uniforms, as we did with the ratio co-ordinates. Let's try sending info on the screen size, by modifying the shader and changing our

“ There's no escaping the fact that manipulation of almost any data is maths ”

uniform send systems to pass position and Screen Size data. Check out the new shader in the code for this lesson: magpi.cc/PryrsN.

Now when we run these we get nice square objects, but there's one last thing we want: the ability to dictate their size.

As our *The MagPi* logo was quite large, our current triangle vertices are actually 0.1f offsets. This means they are already one-tenth their natural size, but we might want to have them be any size. This is called scaling, and again it's best done in the shader. We now need to pass three things to the shader: the co-ordinates (as x and y pixel values), screen sizes, and a scale value.

Now, that is starting to sound like a lot of data to send, and it is. We can live with it for now, but ideally we should try to organise the data in a better

USE GOOD TOOLS

We're about to make a 2D tile game, so find a good tile editor: mapeditor.org

NEVER FORGET THE IMPORTANCE OF GOOD ART!

If you can't draw, make friends with someone who can!

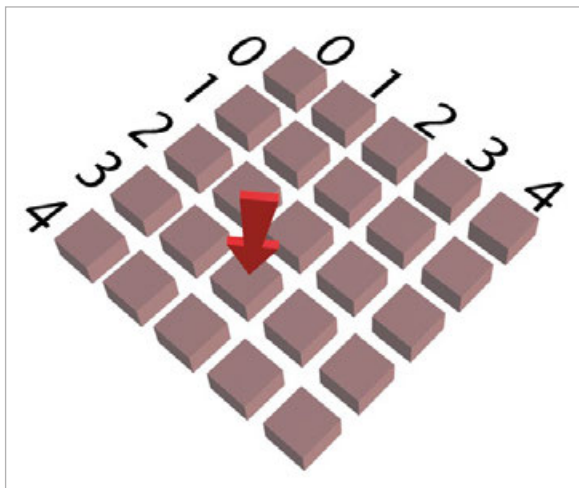

Figure 3

Let's look at what's in box number `zDArrayStreet [3] [2]`

way. To this end, let's consider a couple of data storage concepts.

Arrays and structs

Arrays are useful: they allow us to keep sequences of data in order and accessible. There are actually several types of array, but we only need to use two types for now: single- and two-dimensional (2D) arrays.

A single-dimensional array is like a street of houses (Figure 1), with each house containing some piece of info we want, or allowing us to store or get info. The house number tells us which house to go to, while the name allows us to access the correct street of houses.

```
float ArrayStreet[10] ; // defines an array with 10 float entries
```

So `float value = ArrayStreet[2]` tells us to go to house number 2 (actually the third house*) on `ArrayStreet` and we can load `value` with whatever we find in that house.

* Note that array number systems don't start at element 1, but element 0. This is known as base 0 indexing, since coders regard the number 0 as having a useful value as an index.

Figure 4
Now we can print tiles from a grid

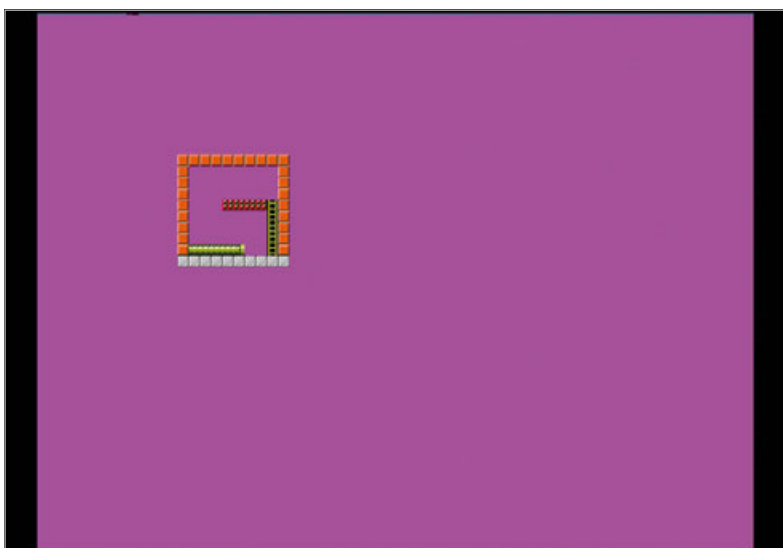

A 2D array can be thought of as rows of streets, with an extra identifier to indicate which row we want, as well as the house identifier.

```
float ArrayStreet2D[Which_Row][House];
```

There's a small downside to an array: it's only able to hold one type of info. So an array of floats means each 'house' can only contain float values, and an array of ints can only contain ints, and so on. We can get round that, though, because it's possible for us to define our own info types, in something called a 'struct', short for structure.

If you look at the code for this lesson ([OGL.h](#)) you will see how we define a struct. This is a really useful concept and lets us define a new 'type' of user variables to suit our particular needs.

Grouping important data in this way keeps it in nice handy chunks that can be stored easily and sent to the shader quite cleanly.

Review the Lesson 4 code and comments to see how we are storing and using the new `simpleVec2` data type.

We'll send pixel co-ordinates to the shader and let it do the maths, so in total we have to send two position floats, easily held in a `simpleVec2`, and two screen size values, also held in a `simpleVec2`, and finally a single float for scale in x and y.

Figure 2 shows our use of the new shader with *The MagPi* logo, but Lesson 4 is now set up to use new tile graphics. Our objects are now square, we can scale their size, and they will stay square unless we decide to add separate x and y scale values.

Creating a playfield

We are now very close to having a working but still inefficient framework. We have a method where we can place objects in pixel co-ordinates. That allows us to place objects exactly where we want to. But it raises a question: what do we want to place?

For now, we want to use tiles. We can now use square objects and set the size, which gives us a perfect opportunity to make use of a 2D array (Figure 3) to show a grid that has tile numbers, and relate them to screen positions.

Check out the `Game` class update within the code. When it starts, it scans through our grid using two loops, and we create and place objects at a relative location on screen.

As well as scanning the grid to make and store objects in a pre-prepared array, we find what tile graphics we need, load them, and then supply a tile with it (Figure 4). Again, it's not actually very efficient, but we'll fix that soon.

Now, we have tiles and a playfield. Next time we are going to create sprites and interact with this new playfield, and talk about C++'s greatest challenge: handling memory.

Can I start a CoderDojo club in my local area?

CoderDojo is a global network of free, volunteer-led, project-based programming clubs for children aged 7–17. Dojos are championed by individuals all around the world who are passionate about giving young people the opportunity to learn to code.

Starting a Dojo is a fun and incredibly rewarding experience

You don't need to possess technical skills to start a Dojo. The most important attribute is that you can bring people together for a shared goal.

We're ready to support you by providing:

- **Learning resources and guides**
- **A free event management system**
- **Certificate templates, digital badges, and giveaways**

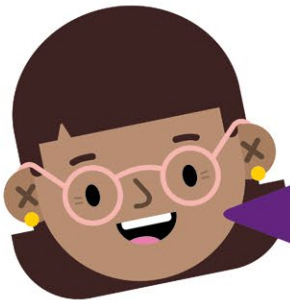

"I started a Dojo to give my kids a place to meet other children also interested in programming and making games. I get to see them making new friends, learning from one other, and they loved it. Realising how I had created such a wonderful place for children has ignited a spark in me."

- Maroes, CoderDojo NL

Start your own club. Join us at [CoderDojo.com](https://www.coderdojo.com)

FREQUENTLY ASKED QUESTIONS

NEED A PROBLEM SOLVED?

Email magpi@raspberrypi.org or
find us on raspberrypi.org/forums
to feature in a future issue.

Your technical hardware and software problems solved...

UPGRADING TO A NEW PI



SHOULD I UPGRADE MY RASPBERRY PI?

Want versus need

If you're happy with your current Raspberry Pi, there's no immediate need to upgrade. Most tutorials and projects are made to be used with any Pi model, and the updates to Raspbian will continue to be made with every Raspberry Pi in mind.

Newer is better

That being said, newer Raspberry Pi models (such as the 3B+ in this issue) have performance improvements over the previous versions. The extra power or

connectivity options might help solve an issue you'd had in a project, or even just improve your Raspberry Pi desktop setup.

For business

If you use a Raspberry Pi in an enterprise setting, newer Pi models tend to have extra functions with business in mind, such as the Power over Ethernet (PoE) pins and PoE HAT coming to the Pi 3B+. Like any new bit of tech, it's worth researching to see if it would aid your company.

WILL MY PROJECTS WORK ON A NEW RASPBERRY PI?

Backwards compatible

Python code and Scratch programs will work just fine when moved between Raspberry Pi models,

assuming you have the correct libraries installed to run them of course. All the tutorials and projects you'll find in past issues of *The MagPi* and on the Raspberry Pi website will continue working with a new Pi model.

Similar hardware

HATs will still work on newer Raspberry Pi boards, so you'll just need to transfer over any relevant configuration files to get them running. The new PoE HAT, though, is designed specifically for the new Pi 3B+, so you won't get it working on a Pi B+ or a Pi 2.

Same Raspbian

The Raspbian operating system is used across all Raspberry Pi models, so there shouldn't be any confusion or need to learn new stuff when getting a new Pi. All the same software and such will also be available on newer hardware.

WHAT SHOULD I DO WITH MY OLD RASPBERRY PI?

Put it to work in the house

If you fancy putting together a file server or finally creating a Kodi box or retro games console, now is the time to do it since you have a spare Raspberry Pi. These projects are easy and quick to make, and at least your old Pi will still be put to use.

Zero to do

While the Raspberry Pi 3B+ is more powerful than a Pi Zero, the Zero's size makes it much more suitable for smaller projects, so don't count it out yet. Keep your Pi Zero for projects that could use it over a bigger and more powerful Pi.

Give it to someone in need

There are many organisations that could do with more Raspberry Pi boards, whether it's your local Jam or Code Club or even a school in need of computers. They don't always need the latest and greatest Pi, as tutorials will work fine across a broad range of different models.

FROM THE RASPBERRY PI FAQ RASPBERRYPI.ORG/HELP

WHAT DO I GET WHEN I BUY ONE?

You get the Raspberry Pi board itself. A power supply and microSD card are not included, but can be purchased at the same time from most places that sell the Raspberry Pi. You can also purchase preloaded microSD cards; we recommend buying these from us or our licensed distributors rather than from third parties on eBay, as our software is updated regularly and cards sold by third parties can quickly become outdated.

WHY IS THE PRICE IN US DOLLARS? YOU ARE A UK COMPANY!

The components we buy are priced in dollars, and we negotiate manufacturing in dollars. Because currency markets are so volatile, we price the final board in dollars as well so we don't have to keep changing the price.

CAN I BUY A RASPBERRY PI KIT?

Raspberry Pi resellers produce some great bundles for people who would rather get everything they need from one source. In 2016, we put together our own Raspberry Pi Official Starter Kit. The kit

is available to order online in the UK from our partners element14 (magpi.cc/qWBdNT) and RS Components (magpi.cc/wRQHGW), for £99 + VAT, and from distributors and resellers around the world.

IS THERE A BUY-ONE-GIVE-ONE PROGRAMME?

Not at the current time. We may implement a programme of this sort one day, but the scale of an undertaking like this is something our small team isn't equipped to handle. You can, of course, simply buy an extra Raspberry Pi to donate to the person or organisation of your choice.

I WANT TO BE A RASPBERRY PI RESELLER.

We have an exclusive manufacturing and distribution arrangement with RS and Farnell. Resellers buy the Raspberry Pi in bulk from them (which reduces shipping costs to nearly nothing) and sell on. You do not need any special licence to resell, and the distributors are very happy to sell on to resellers. If you are interested in joining our Approved Reseller programme, contact us by sending an email to info@raspberrypi.org.

INTRODUCING THE HOTTEST NEW PRODUCTS FOR YOUR PI



THE NEW PiTraffic

Take your first steps into interfacing with the real world. PiTraffic provides the building blocks to explore ideas and take learning further. Just pop it on your Pi and start to learn coding.

FEATURES

- Compatible with Raspberry Pi 3, 2, B+, A+, Zero, and Zero W
- Fully assembled
- Easy Programming
- 40-pin female header included to boost height for Pi B+, 2, 3

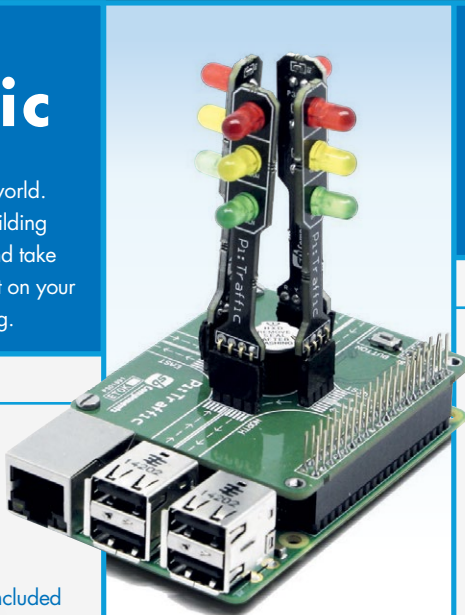

PiCube

PiCube is a 4x4x4 LED Cube perfect for both beginners and professionals to strengthen their logic by typing complex code to draw out different patterns among its various uses.

FEATURES

- Each Layer as well as each LED can be individually accessed and controlled as per requirements
- 64 high intensity monochromatic LED's
- 40-pin stacking header for accessing GPIO of RPi
- Available in three vibrant colours RED, GREEN, BLUE
- Comes un assembled and fully assembled

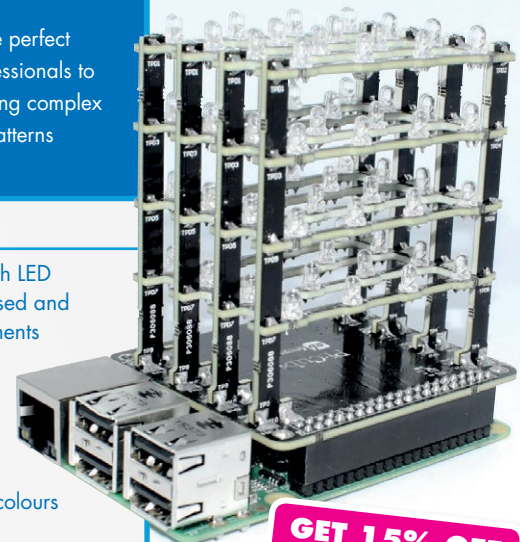

GET 15% OFF
PiTraffic & PiCube
with this code:
MAGPI2017



www.shop.sb-components.co.uk Call: **0203 514 0914**

At **SB Components** we strive to offer our customers the best prices for the best products. Our product team works tirelessly to source top quality affordable components from around the world. Raspberry Pi is a trademark of the Raspberry Pi Foundation. Raspberry Pi not included.

Pi WARS 2018

WELCOME TO THE **OLYMPICS**
OF RASPBERRY PI ROBOTS

2014

The obstacle course for the first Pi Wars was much simpler



The Raspberry Pi has helped revolutionise many things. From computing education, to the maker community, and even how you play games at home, the Raspberry Pi has had a huge impact. It's also helped change the face of hobby robotics, making it more accessible than ever before.

To celebrate this renaissance of robotics, the organisers of the regular CamJam event hold a yearly contest known as Pi Wars that pits the Raspberry Pi community's best automated efforts against each other. There's no fighting, though: the robots take part in devious challenges designed to test how well they've been built and programmed, and at the end of the day they get to be taken home in one piece! Most of the time.

This year, over 70 teams are taking part over two days. Here's what you can expect from the event.

THE HISTORY OF PI WARS

THINGS HAVE CHANGED OVER THE YEARS. HERE'S WHAT HAPPENED AT THE LAST THREE PI WARS

Pi Wars is a spin-off from the CamJam – the Cambridge Raspberry Jam. Now in its fourth year, the competition has grown in size and scope, as challenges and team categories are added or updated so that the contestants can get a truly fair test of their skills against their peers.

Michael Horne, CamJam and Pi Wars organiser, tells us a little bit about the history of the event...

PI WARS 2014

This competition, in December 2014, was our first, and was held at CamJam's previous regular home at the Institute of Astronomy. The courses were a little low-tech – unpainted hardboard, courses on table tops, and a line-follower course made out of paper taped together. It took place over just one day and we split robots based on cost – sub-£75 and over-£75 (not including the Raspberry Pi). Challenges were as follows: Obstacle Course, Line Follower, Proximity Alert (get as close as possible to a wall), Robot Golf (push a ball through a hole in a wall), Straight Line Speed Test, Sumo Battle, and the fiendish

Three Point Turn which was an autonomous test of a robot's ability to drive forward, make a turn in the road, and then return to its starting position.

PI WARS 2015

The 2015 competition was also held in December and we moved venue, to the Cambridge Computer Laboratory (William Gates Building), to give us some more space to work with. The courses were much better presented – featuring actual paint! – and we changed some of them to keep things fresh. The challenges were: Obstacle Course (with different obstacles and featuring the brand new turntable, designed and created by PiBorg), Skittles (knock the pins over with a ball), Pi Noon (robot vs robot balloon popping), Straight Line Speed Test, Three Point Turn, Line Follower, and Proximity Alert. This time, robots were split between those under A4 size and those between A4 and A3 size. This increased size gave us some challenges as the courses needed to allow for larger robots.



2017

A tense Pi Noon match at last year's Pi Wars event

PI WARS 2017

For 2017, we decided to move the event to April to allow schools, in particular, more time to work on their robots and to avoid exams. We also decided to hold the event over two days, with schools taking centre stage on the first day and everyone else being divided into three categories on the Sunday: Beginners, Intermediates, and Advanced. We were welcomed back to the Cambridge Computer Lab and this was the busiest event yet with around 60 robot teams competing.

The challenges were once again revised: Straight Line Speed Test (which was changed to a strictly autonomous event), the Minimal Maze (a new autonomous course), Line Following (which used the outline of our robot logo – much to the dismay of many teams!), Pi Noon (which added another two balloons as targets to be popped), Obstacle Course (which doubled in size from previous years), Skittles (this time, teams had to go and 'collect' the ball to be rolled at the pins – a slight misstep on our part as it proved to be a very tricky physical challenge!), and Slightly Deranged Golf (in which a real golf ball had to be moved around a short course and through a windmill's rotating sails at the end and into a hole).

SIGN UP FOR THE NEXT PI WARS!

Registration for the next Pi Wars isn't open yet but when it is, you'll find it on piwars.org around autumn time. Make sure you apply early – registrations close before the event and you can't just turn up on the day with a robot in hand!



2015

The obstacle course received a big update for 2015, including the now famous turntable!

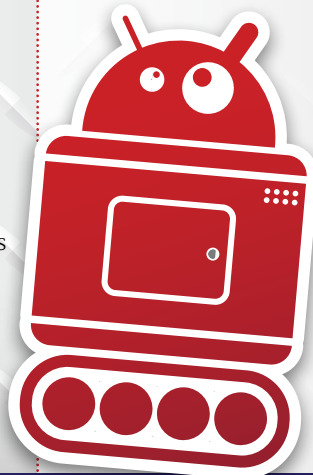

HOW TO BUILD A ROBOT

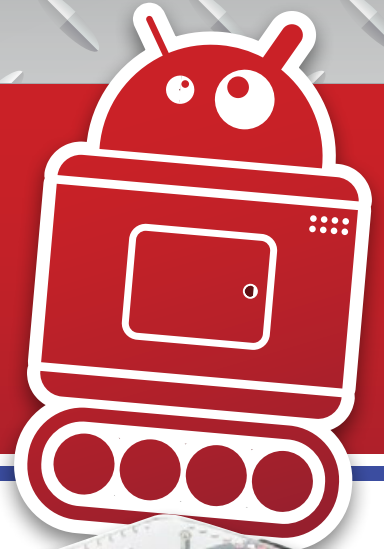

WANT TO ENTER PI WARS? YOU'LL NEED A ROBOT THEN...

WHERE TO BUY ROBOT PARTS

MODMYPI

magpi.cc/HdcIvp

As well as selling kits from PiBorg, one of the leading Raspberry Pi robotics makers, ModMyPi has other kits and plenty of robot components.

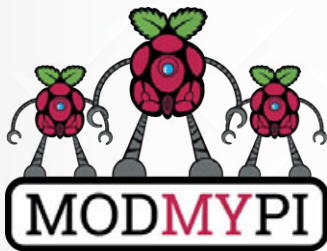

ADAFRUIT

magpi.cc/skzElb

America's premier hobby electronics supplier also has an amazing range of robot parts and kits that it has developed itself.



DEXTER INDUSTRIES

dexterindustries.com

Dexter is a hobby robotics specialist, with a number of kits and sensors and such made specifically for the Raspberry Pi. You can buy its products from ModMyPi in the UK.



GOOD STARTER KITS

If you want to learn how to make robots, you need to start at the beginning. Here are some great starter kits that you can go on to expand into your own robo-competitor.

DIDDYBORG V2 ▶

> £210 / \$290

magpi.cc/MokmEg

An expensive kit but a very good one – PiBorg's DiddyBorg is a powerful Raspberry Pi robot running on six wheels to make it extra sturdy. You'll be able to outrun all your opponents with it, and you can easily add sensors to make sure it can be fully autonomous.



YETIBORG V2 ▶

> £160 / \$220

magpi.cc/TADbiy

From the robot boffins at PiBorg, the new version of the YetiBorg is built to run on a Raspberry Pi Zero. It's small, powerful, and extremely well put together, much like the other PiBorg offerings. The ZeroBorg motor controller it comes with lets you add standard analogue sensors, and can be daisy-chained too.

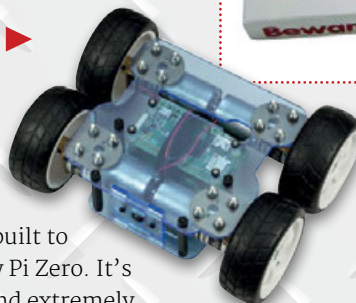

GOPIGO ▲

> \$200 / £200

magpi.cc/dYpiRj

The GoPiGo 3 kit is a great starter for people wanting to learn how to code and control robotics. With the base kit and a great set of tutorials, you'll quickly figure out the basics. The controller board lets you connect extra sensors, allowing you to learn and grow your robotics skills.



CAMJAM EDUKIT 3 ▲

> £18 / \$25

magpi.cc/tNKkmk

A great, classic starter kit, the CamJam EduKit 3 comes with the basics for making a robot. You'll need to add a Raspberry Pi and chassis – although you can always use the box for the latter! It's a very simple robot, but it does teach the basics and has decent parts that you can use when building your robot.

BUILDING TIPS

TYPES OF SENSORS

ULTRASONIC RANGE FINDING

magpi.cc/UJaTWJ

Ultrasonic sensors use ultrasonic sound waves to measure distance. They're pretty popular among robot kits because not only do they help teach you about sensor programming, they also look like eyes.



CAMERA SEE THE WORLD

magpi.cc/28ljIsz

With a bit of skill, and a lot of help from the OpenCV software library, you can get a Raspberry Pi robot to react to the world around it. It's mainly used for differentiating colours, but OpenCV is very powerful and can do more.

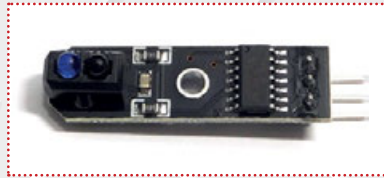
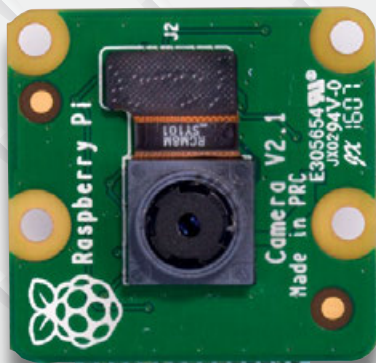

LINE FOLLOWER TRAVEL IN A STRAIGHT LINE

magpi.cc/ujFFZz

These sensors are great at following a line drawn on the floor, by sensing the difference in shade between the two. Line-follower sensors are usually hidden under a robot and used for fun circuit challenges.



INFRARED ANOTHER RANGE FINDER

magpi.cc/rVRhWP

Depending on material, an infrared range finder can be more accurate than an ultrasonic one. However, they don't work so well outdoors. Luckily, Pi Wars is an indoor event!

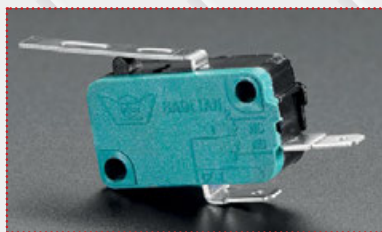

MICROSWITCH SENSITIVE BODY SENSORS

magpi.cc/vywZnT

Some simple robot kits make use of microswitches to figure out when they've hit a wall. Classically, the robot will then turn away from the wall, but you can always add one as a shut-off switch for a straight-line speed test

ROBOT BUILDING RESOURCES

WANT A HAND BUILDING A ROBOT? MAYBE THESE PLACES CAN HELP

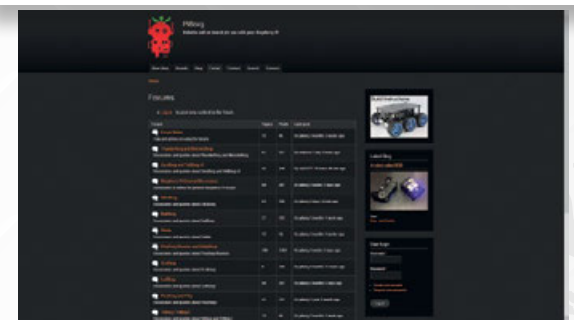

PIBORG FORUM

magpi.cc/RmbMDY

The PiBorg forum is a great place to ask about PiBorg kits. The team behind them are experts at robotics as well, so they should be able to help you with any query.

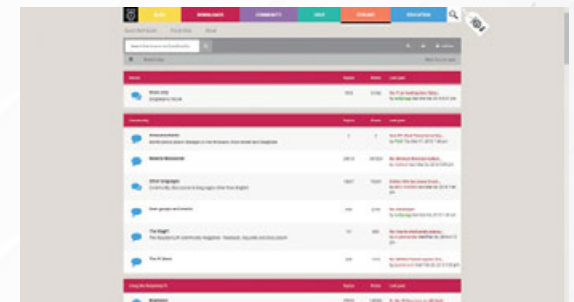

RASPBERRY PI FORUM

raspberrypi.org/forums

The Raspberry Pi community are always happy to help someone in need. Give the forum a search first to see if any of your questions have already been answered.

PREVIOUS ISSUES OF THE MAGPI

We've done robot tutorials in the past - including a guide on how to make and upgrade one in issues 51 and 52 respectively.

magpi.cc/issues



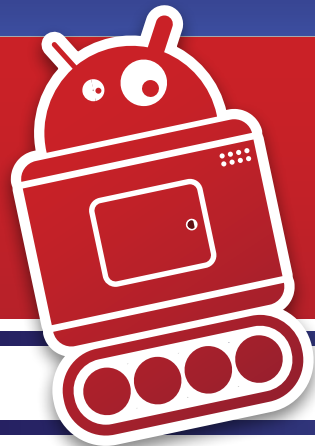

HOW WINNERS BUILD THEIR ROBOTS

HERE ARE SOME OF THE TOP ROBOT TEAMS FROM PAST PI WARS - WHAT HELPED THEM WIN?

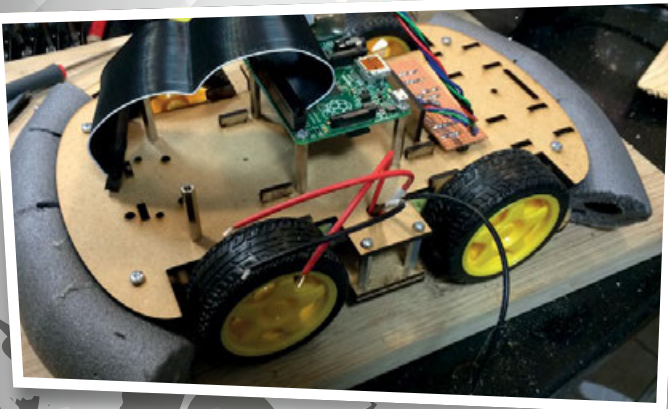

TRACTORBOT

CONTEST: PI WARS 2014
WINNER: UNDER £75
BUILDER: IPSWICH MAKERSPACE

One of the first winners of Pi Wars, the TractorBot was made out of laser-cut wood and created by the folks at Ipswich Makerspace, who are veterans of the competition.

One of the unique features of TractorBot was the interchangeable noses for different contests – for example, for the golf game they used an extended nose that would keep the ball rolling ahead of the robot. Unfortunately, while good for keeping the ball under control, it did not help to release the ball through the hole. They were also able to add pipe insulation for the sumo contest to soften impacts on the robot.

REVENGE OF PYROBOT

CONTEST: PI WARS 2015
WINNER: LARGER THAN A4
BUILDER: BRIAN CORTEIL

Brian Corteil should be recognisable to readers of the mag – he wrote our feature on building a robot in *The MagPi* #51, which was then further developed into the Tiny 4WD. He entered the first

Pi Wars with the robot PyroBot, which unfortunately did not place. However, he came back stronger in 2015 with the Revenge of PyroBot.

“My robot Revenge wheel layout was inspired by PiBorg DiddyBorg kit layout,” said Brian. “I built the chassis in a weekend and was driving it on the Sunday evening. The rest of the robot was added over the following months, with the final design put together on the Friday evening before Pi Noon!”

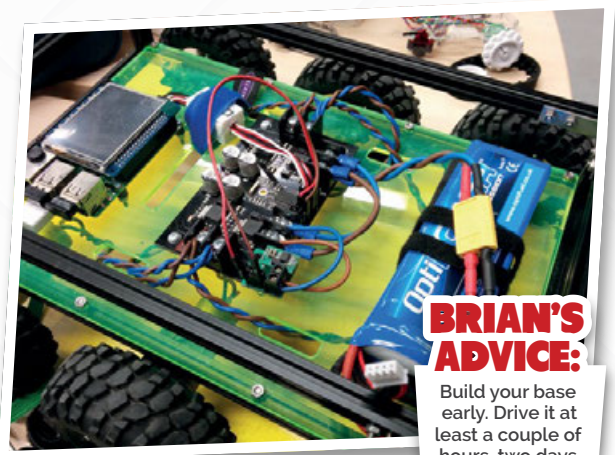

BRIAN'S ADVICE:

Build your base early. Drive it at least a couple of hours, two days a week.

KEITH EVOLUTION

CONTEST: PI WARS 2015
WINNER: A4 AND SMALLER
BUILDER: ANDY & HARRY MERCKEL

KEITH Evolution is the second robot by the Merkel team, the aptly named evolution of their robot KEITH from the first Pi Wars. KEITH stands for Kinetic Electronic Interactive Tracked Hardware.

Evolution was built specifically for the A4 category, with the aim to make a bigger and better robot than the original. The ability to swap attachments was dropped because of the time involved (although one was created for Pi Noon). It was a much sturdier beast, using more custom parts than before as well.

“We tried to build a robot that would be able to do well in all of the challenges,” the team wrote. “Although there were many compromises along the way!”

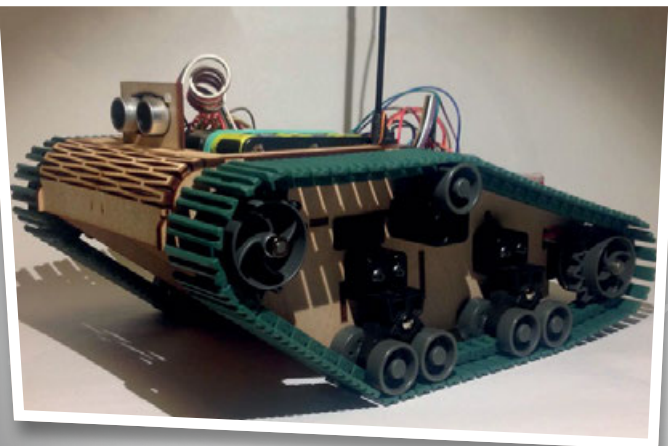

EXABOT

CONTEST: PI WARS 2017
WINNER: SCHOOLS AND KIDS CLUBS
BUILDER: TEAM EXABOT

“Our team built a completely custom robot for this year’s competition,” the team wrote on their blog. “Working on everything from the core electrical and mechanical design to the Python program used to operate the robot

– along with a lot of training to get to grips with some of the challenges awaiting at Pi Wars.”

While of course the robot build is very important, training and testing should not be overlooked. The ExaBot team even went as far as building their own maze to tweak their software at the last minute, finding some issues they were able to account for before the big day. Still, issues were found during the challenges, so you can’t account for everything.

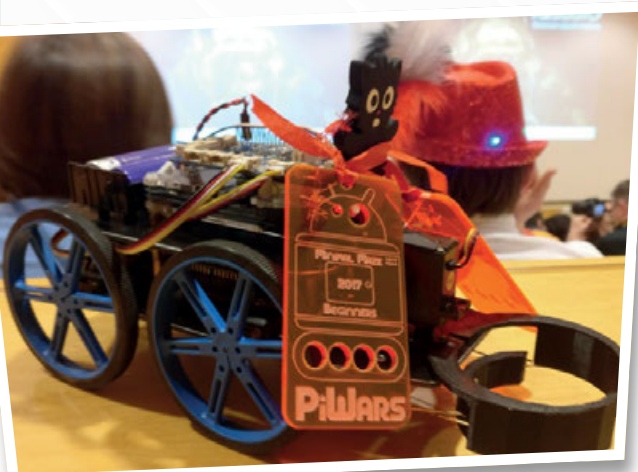
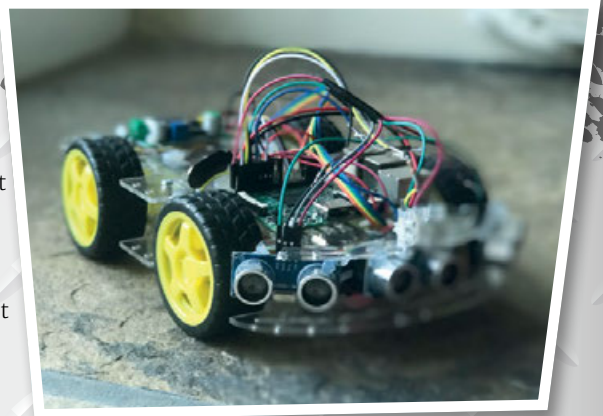

MR BIT

CONTEST: PI WARS 2017
WINNER: BEGINNERS
BUILDER: BROUGHTON FAMILY

Tom Broughton and his daughter Rebelle had never built a robot before, but that wasn’t going to stop them from entering Pi Wars – after all, it did now have a Beginners category. You can follow the very careful progress of building the robot on Tom’s blog (digitalpolymath.co.uk),

with he and Rebelle learning as they went. Simpler solutions were found in favour of going over the top, including one involving the use of multiple distance sensors for the maze, and a simple claw/mandible design controlled by motors for manipulating the ball in the golf challenge.

“Very naively we assumed it would be a very simple task to put a robot together,” Tom admitted. “But we soon realised, as mentioned in many of our posts, what a huge underestimation this was.”

STEVE

CONTEST: PI WARS 2017
WINNER: INTERMEDIATE
BUILDER: TEAM STEVE

Steve is not a fancy acronym (or backronym?) like KEITH, but is instead just a robot called Steve. A robot that looks like a dog. Steve had been in the works for

months before the April 2017 Pi Wars event, going through different controllers as the robot was built and tested. In the end, Steve ended up being a modest robot, running off a Raspberry Pi Zero and an Arduino, and using a Dagu chassis and speed controller. Despite this, it managed to win the Intermediate category and even came first in the golf challenge. Good boy, Steve!

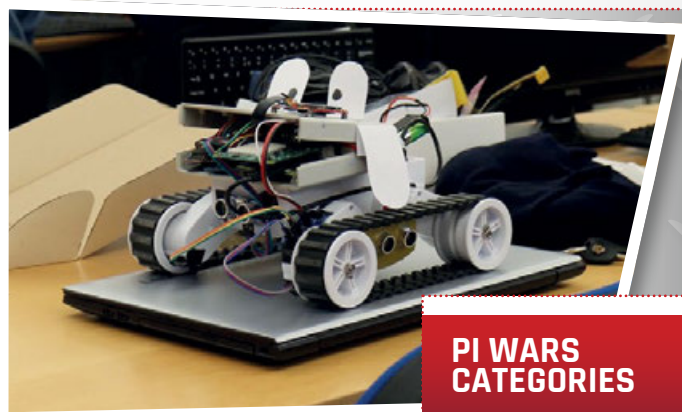

PI WARS CATEGORIES

PI WARS 2014

- Under £75
- Over £75

PI WARS 2015

- Larger than A4
- A4 and smaller

PI WARS 2017

- Schools and Kids
- Clubs
- Beginners
- Intermediates
- Advanced/Pro

MAX

CONTEST: PI WARS 2017
WINNER: ADVANCED/PRO
BUILDER: 2 WHEELS OR NOT 2 WHEELS

Brian Corteil came back to Pi Wars last year with another winner in Max, based on the Tiny robot that was originally built for *The MagPi!* Brian is great at building powerful, sturdy robots and Max is no

exception, especially compared to the balancing two-wheel robot he had originally planned for the 2017 competition (hence the team name).

Compared to the Tiny and the Tiny 4WD, Max has an additional series of distance and line sensors and a more custom chassis. While it didn’t do particularly well in the automated events, Brian’s tactic of practising his robot control paid off, with him placing highly in (and even winning two of) the manual-control events.



HOW TO CONQUER THE CHALLENGES

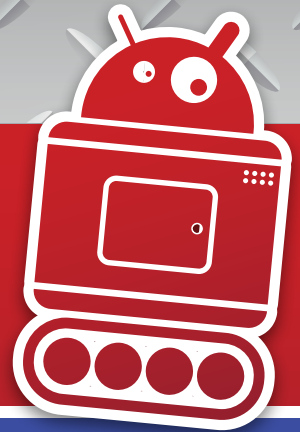

THE EVENTS AT PI WARS TEST THE BUILD QUALITY AND PROGRAMMING SKILL BEHIND EACH ROBOT. CO-ORGANISER MICHAEL HORNE REVEALS THE TASKS THEY NEED TO CONQUER

AUTONOMOUS CHALLENGES

STRAIGHT-LINE SPEED TEST

HOW FAST CAN YOUR ROBOT GO IN A STRAIGHT LINE?

A shallow trough 7.3m (24 feet) long comprises the course for the speed test. Your robot needs to traverse this course autonomously as fast as possible, without hitting the sides. The course is usually 534 mm wide, but there are sections where it will narrow.

With a white line down the centre which you can use for navigation, the course will be run three times and the scores for each run added

together. While it seems like it will be simple, any robot maker knows that very few robots go in a straight line without some coding help.

OFFICIAL TIP: It's important to get a balance between being as fast as possible and being as accurate as possible – we've added chicanes which count as 'walls' which incur penalties when touched.



SOMEWHERE OVER THE RAINBOW

YOUR ROBOT NEEDS TO FIND AND TOUCH A SERIES OF COLOURED BALLS, PREFERABLY IN SEQUENCE

Robots are placed at the centre of a square arena in this new challenge. The wooden arena measures 122 cm

by 122 cm, and the black walls are 300 mm high. At each corner there's a coloured ball suspended 100 mm off the floor of the box. Your robot must visit each ball once, and they can do that in any order, or shoot for more points and go in the predetermined order of Red, Blue, Yellow, and Green.

The kicker? Each ball's placement will be random for each team, so the robot truly has to look for the correct colour. Contestants have seven minutes to perform

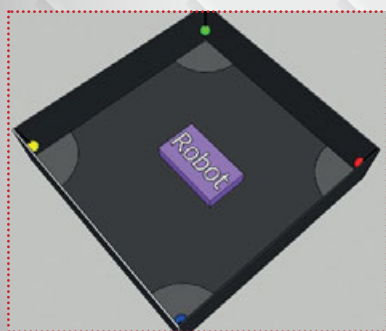

THE MINIMAL MAZE

ROBOTS NEED TO AUTONOMOUSLY NAVIGATE A SIMPLE MAZE

Don't let this simple-looking maze fool you: this can be quite tricky for robots as you're not allowed to help them, and they're not permitted to touch any walls.

The concept behind this maze is for your robot to sense the different colours that are painted on the wall to inform how it navigates. Programming your robot to turn while seeing certain colours, and only moving so much at a time, is key to navigating the maze successfully. While slow and steady can win the race, the event is measured on completion time, so don't dawdle.

OFFICIAL TIP:

There are so many ways to do this, but we've allowed the addition of 'markers' on the course which might be an easy way to orientate yourself if you use 'vision' to navigate.

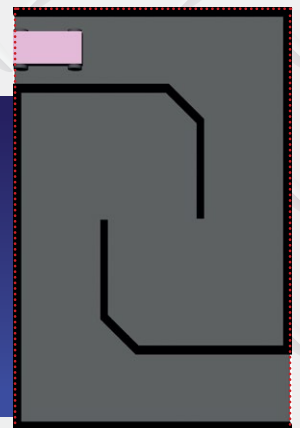

a maximum of three attempts, with their fastest attempt used for scoring.

OFFICIAL TIP: We're supplying a calibration or 'try out' course in addition to the 'real' course – use it to get your sensors in shape before the real runs.

REMOTE-CONTROLLED CHALLENGES



SLIGHTLY DERANGED GOLF ▲ YOUR ROBOT MUST PUSH A GOLF BALL THROUGH A DEVIANT COURSE TO THE HOLE

Think mini golf in this excellent challenge that showcases your robot's dexterity and your team's ability to precisely control it. A real golf ball must be pushed around a golf course, avoiding obstacles, and dropped into the hole at the end.

You can't carry the ball, and the ball is only allowed to leave the surface of the course if the team/robot decides to chip the ball. Otherwise, pushing and hitting the ball is the way to go. Teams can't be cheeky and 'capture' the ball with the robot either. The total time after three runs will be used in scoring.

OFFICIAL TIP: We've lowered the tee this year, so it should be easier, but get control of the ball early!

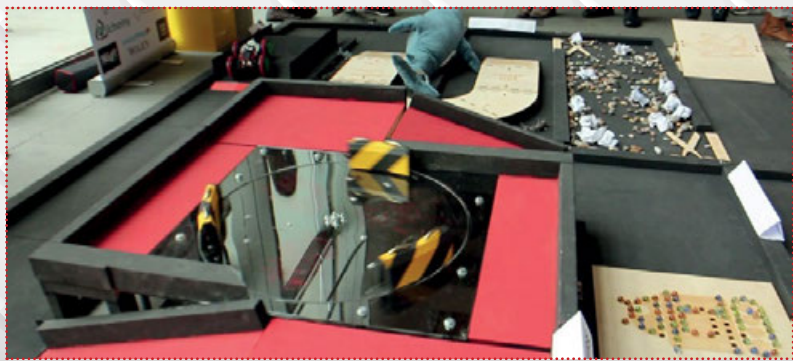

PI NOON ► BURST YOUR OPPONENT'S BALLOONS USING SUPERIOR MOBILITY AND TACTICS

An audience-favourite challenge that somewhat resembles the battle mode from Mario Kart. Each robot is equipped with a series of tiny balloons, along with a needle. The aim is to pop your opponent's balloons with your needle, and not have your own popped.

Each duel lasts three minutes. There are many rules, such as 'don't spin' and 'don't purposefully damage the opponent', which are mainly in place to reinforce that this is supposed to be a fun event that you shouldn't try and game by being silly. Remember, judges' decisions are final.

OFFICIAL TIP: Practise remote-controlling your robot as much as possible, as control is vital in this challenge.

THE OBSTACLE COURSE ▼ NAVIGATE AN OBSTACLE COURSE IN THE FASTEST TIME

The obstacle course is a lot of fun... to watch. Robots regularly get a bit stuck and teams usually get a bit frustrated, which makes for great drama. It should be televised really.

While the exact layout of the obstacle course is a mystery until

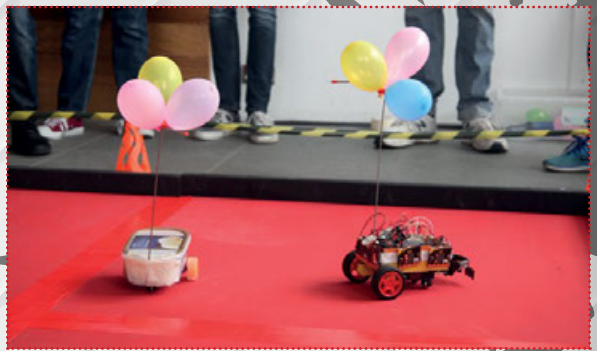

the day, in the past there have been ramps, marbles, sharks, and The Big Whirling Circle™ to contend with. Contestants need to figure out the best way to tackle each obstacle, and hopefully prepare their robot for any eventuality. You only get one attempt, and you'll be judged on how fast you complete the course. Although don't just try to charge through obstacles.

OFFICIAL TIP: Without giving too much away, make sure you can get out of tight spots, maintain control, and practise slow turns. Grippy wheels will help this year, too.

THE DUCK SHOOT TARGET SHOOTING WITH ROBOTS!



Robots will be placed in front of the targets, and will not be allowed to cross a boundary line that is at least a metre away from the targets. Several targets will be presented between 10 and 15 cm in height, held at different elevations, and not all at the same distance from the boundary.

Robots can either use five supplied balls to knock down the targets, or use a pre-installed cannon that fires up to five soft projectiles (such as Nerf darts). Any method of aiming is allowed (including laser pointer). Contestants have five minutes to make three attempts, and points will be tallied up depending on how many targets are hit.

OFFICIAL TIP: You only have five shots, so be as accurate as possible and take your time to line up.

OTHER WAYS TO WIN

While completing challenges is the main way to gain points, robots will also be judged on other aspects...

BLOGGING

Keeping a log of how you built the robot, with added photos and video, can help you win extra points.

TECHNICAL MERIT

Your robot goes before the trained eyes of engineers to ascertain the quality of your Pi-powered machine.

ARTISTIC MERIT

Does your robot look cooler than a T. Rex surfing while wearing sunglasses? Then it will win some extra points.

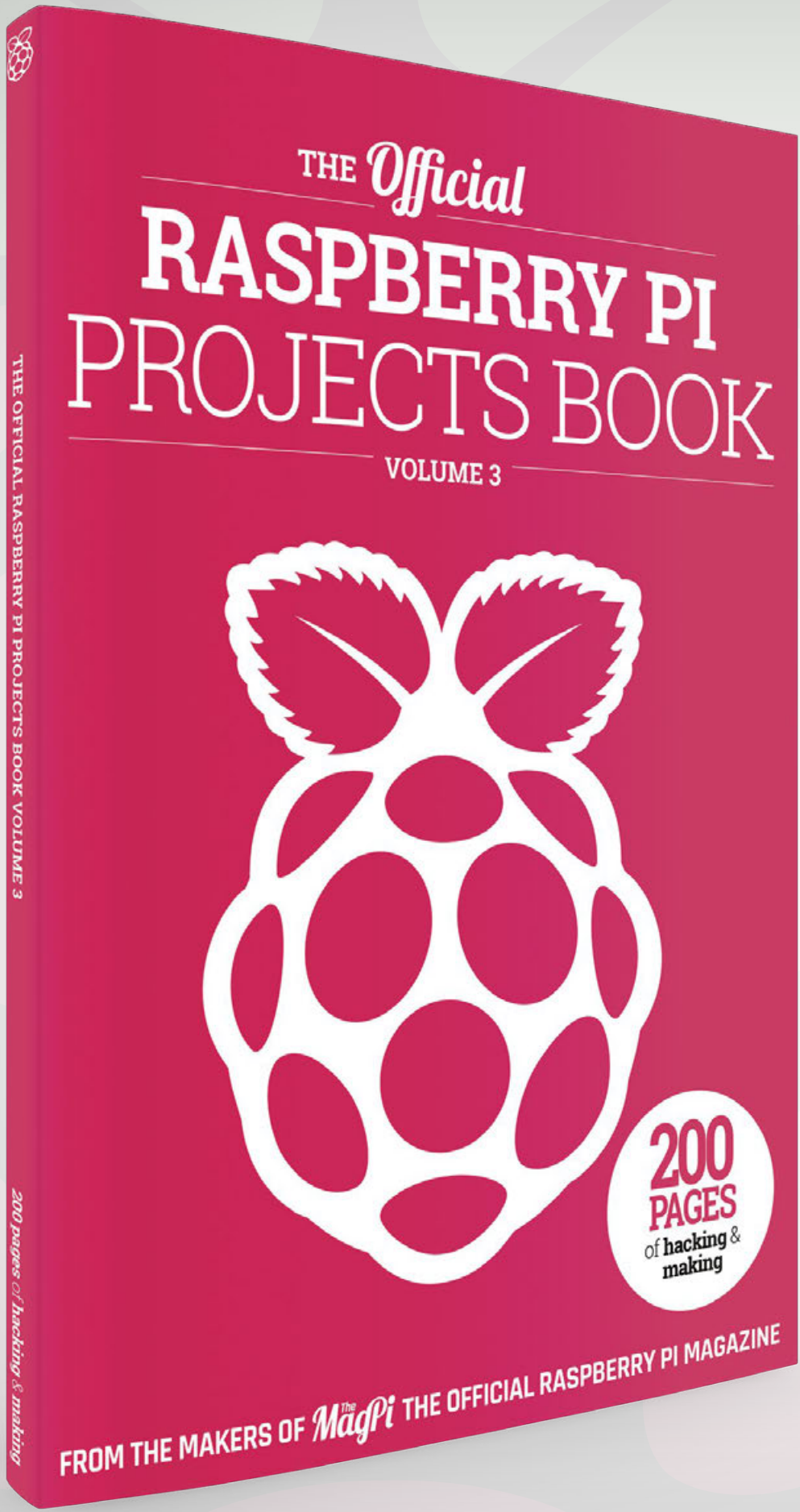

£12.99

200 pages of
Raspberry Pi

THE *Official*

RASPBERRY PI PROJECTS BOOK

VOLUME 3

Amazing hacking and making projects
from the makers of *MagPi* magazine

Inside:

- How to get started coding on Raspberry Pi
- The most inspirational community projects
 - Essential tutorials, guides, and ideas
 - Expert reviews and buying advice

Available
now

magpi.cc/store

plus all good newsagents and:

WHSmith **BARNES&NOBLE**



Available on the
App Store



GET IT ON
Google Play

matrix.one

From £40 / \$55

MATRIX VOICE

A voice-recognition board featuring an LED loop and eight-mic array. **Phil King** has a few words with it

Measuring 3.14 inches (8 cm) in diameter, this circular add-on should, in mathematical terms at least, prove a perfect fit for the Raspberry Pi. A GPIO header extender enables it to clear the Pi 3's USB ports, but will also work with any newer 40-pin model, including the Pi Zero. It looks good mounted on top, a blue LED on its underside illuminating the Raspberry Pi board below.

In essence, the Matrix Voice is a slimmed-down spin-off of Matrix's original Creator board. Whereas the Creator was crammed with all sorts of sensors, and

a Xilinx XC6SLX9 Spartan 6 FPGA (field-programmable gate array), whose 9152 logic cells offer scope for customisation if you know how.

ESP or not

Two versions of the Voice are available: standard and ESP32 with built-in WiFi and Bluetooth. While the former relies on connection to a Raspberry Pi, the latter (costing an extra \$10) can be programmed on a Pi before being set free to function as a standalone device. The most visually impressive aspect of the Voice is its circular 'Everloop' array of 18 RGBW LEDs. As well as the

unable to use it to access the Raspberry Pi's GPIO pins directly.

Many voices

One of the key plus points of the Voice is its compatibility with a wide range of voice assistant platforms, including Amazon Alexa, Google Assistant, and PocketSphinx. Disappointingly, however, getting started with the device is made more difficult by the lack of helpful, Voice-specific information on the **matrix.one** website. A lot of the documentation and examples are related to the Matrix Creator, and the Voice data sheet only offered links to a couple of tutorials. Matrix tells us it is working on creating additional ones and improving the documentation.

Following the Alexa step-by-step guide (magpi.cc/Wzovwo) took

Compatible with a wide range of voice assistants, including Alexa and Google Assistant

other bells and whistles, the Voice focuses on voice recognition. To this end, it retains the array of eight digital MEMS MP34DB02 microphones, although here they're arranged differently: seven placed at regular intervals around the perimeter and an eighth in the middle. Audio processing – including noise cancellation and de-reverberation – is handled by

ability to display cool light patterns, this can provide useful visual feedback during voice interactions.

Near the middle of the board, as on the Creator, is a square hole for mounting a Camera Module if you wish. Elsewhere, a 24-pin female expansion header is connected to the FPGA to connect and control electronic components, but (testing it with a basic LED circuit) we were

Related

AIY VOICE KIT

Google's cardboard kit for voice recognition includes a mini speaker and two-mic array, while its Voice HAT board features connections for servos and motors.



£25 / \$25

magpi.cc/AWwXwv

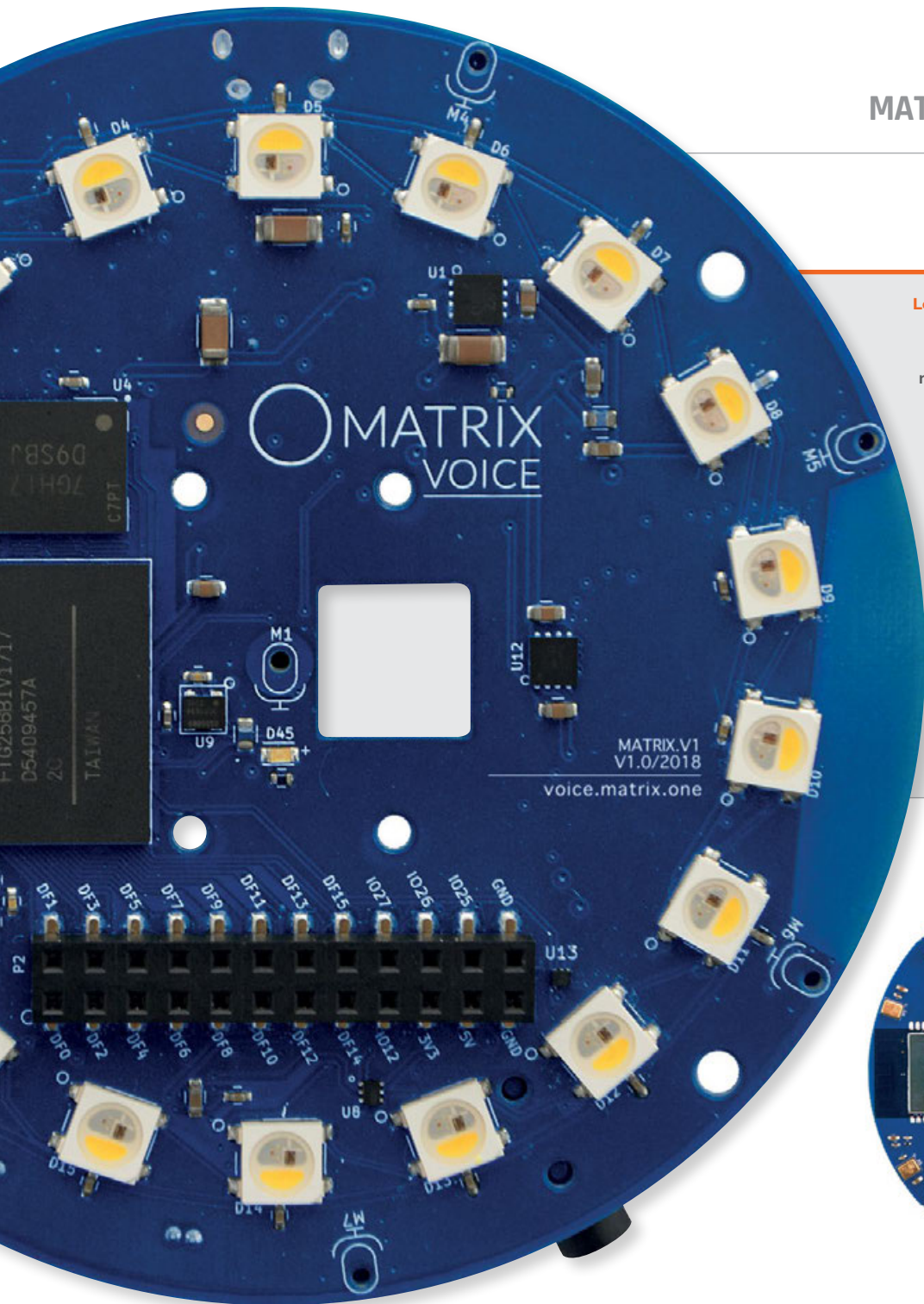

Left The top of the Voice features a ring of 18 RGBW LEDs and eight mini microphones

Maker Says

A complete, affordable, and user-friendly tool for simple to complex IoT voice app creation
Matrix

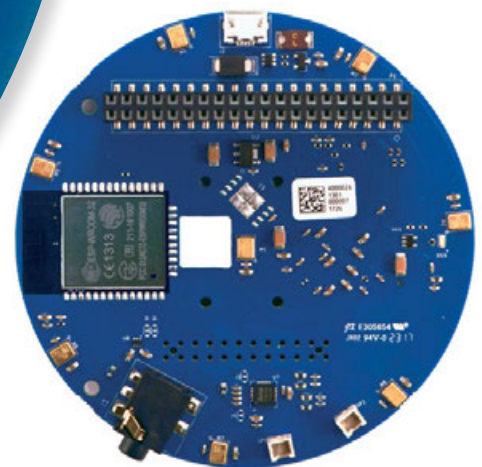

over two hours, including lengthy Matrix software installation and setting up a developer account with Amazon. We had problems getting it to capture our voice at first, but upon reinstalling to a fresh Raspbian Stretch image it worked well. The mic array was able to pick up our “Alexa” wake-word even from the far side of the room, the LED loop glowing green as Alexa then listened to our enquiries and commands. For sound output to a speaker, for some reason we were advised to use the Raspberry Pi’s 3.5 mm jack rather than the one on the Voice.

Exploring Matrix’s GitHub repo, we discovered a PocketSphinx example (magpi.cc/qLRbbH) to show LED patterns triggered by speaking various phrases. Examining the demo code (written, like the other examples, in C++) gave us an insight into how to listen for keywords and trigger the LEDs. Of the few other code examples compatible with the Voice, we found one for sensing the direction of sounds using the eight mics. While possibly useful for a project, the demo code (for the Creator) would need altering to suit the Voice’s different mic array layout.

While the Matrix Voice is clearly a capable piece of hardware, until the documentation improves it’ll be hard to make the most of it.

Last word

The Matrix Voice hardware is polished, capable, and versatile, but the lack of specific product support on the Creator-focused website currently makes it difficult for users to get started. While the Voice’s spec is superior, its price is also higher than some simpler rivals, such as the Seeed ReSpeaker 4-Mic Array (£23) and Joy-IT Talking Pi (£31), which may well be sufficient for many home projects.



Maker Says

Files on demand for everyone
Make Mark App

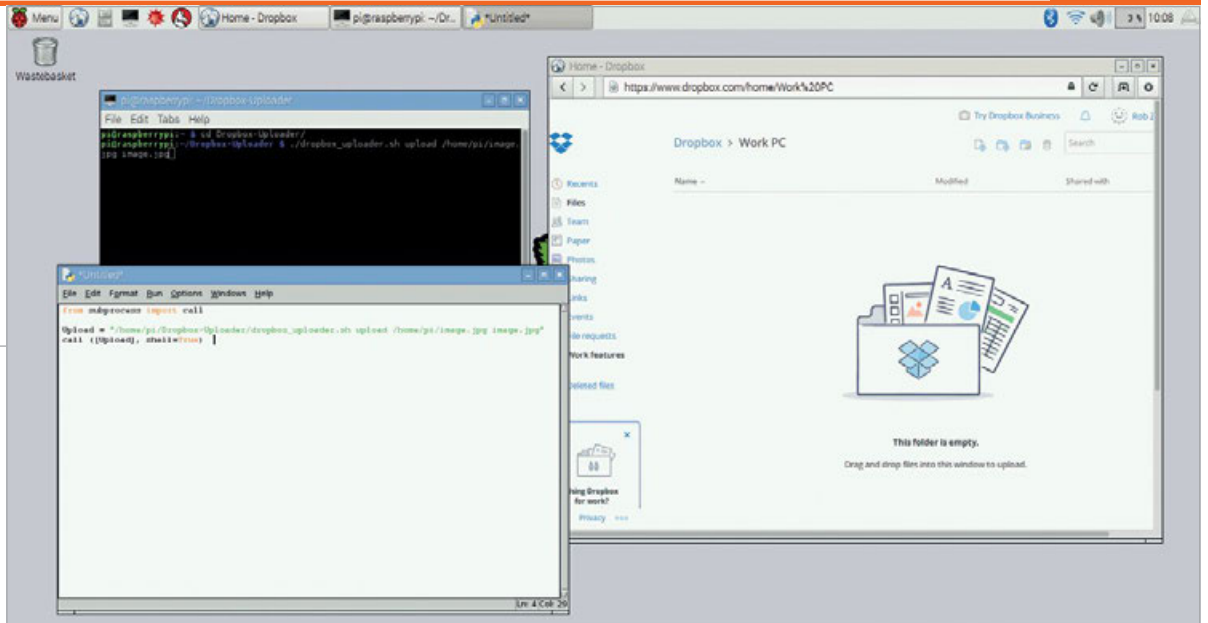

MAKE MARK APP BETA

Rob Zwetsloot investigates a different way of linking Dropbox to Raspberry Pi using middleware

Dropbox has never been very well supported in Linux. Raspbian has it even worse than standard flavours of Linux. In the past, getting Dropbox to sync to a Raspberry Pi has required some custom coding, but Make Mark App makes the process a bit easier.

creating folders on the Raspberry Pi, setting up folders on Dropbox, and making it launch at boot. You can then log in to Make Mark from the website and manage your files.

Still in beta, the software currently only supports PDFs and e-book files. The system truly acts

on making it better. Instructions and documentation are provided in somewhat broken English, although they're easy enough to understand to get you started.

While it's not the full auto-syncing solution we'd been hoping for, it does work well as a middle step for transferring files between the Raspberry Pi and Dropbox. We look forward to seeing it become easier to install and support more files in the future.

Related

THE CLASSIC DROPBOX SETUP

Want to use the usual Dropbox syncing method for Raspberry Pi? Check out our tutorial straight from issue 48 of The MagPi.

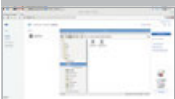

magpi.cc/2c9NnPC

Works well as a middle step for transferring files between the Raspberry Pi and Dropbox

It's still a little DIY: you need to set up Make Mark as an app in the developer section of your Dropbox account and get an app token. With that, you can download a script that will set up everything you need to install the app. This includes

as middleware – it will list what files you can upload from your Raspberry Pi and then has you manually do so. They'll then show up in Dropbox in the Make Mark App folder.

We had a little trouble with setup, but the developer is working

Last word

It's definitely a beta, but shows great promise for a future middleware app for Raspberry Pi and Dropbox.



HackSpace

TECHNOLOGY IN YOUR HANDS

THE **NEW** MAGAZINE
FOR THE **MODERN MAKER**



SUBSCRIBE AND
SAVE UP TO
35%
on the cover price



ISSUE #05

OUT NOW

hsmag.cc



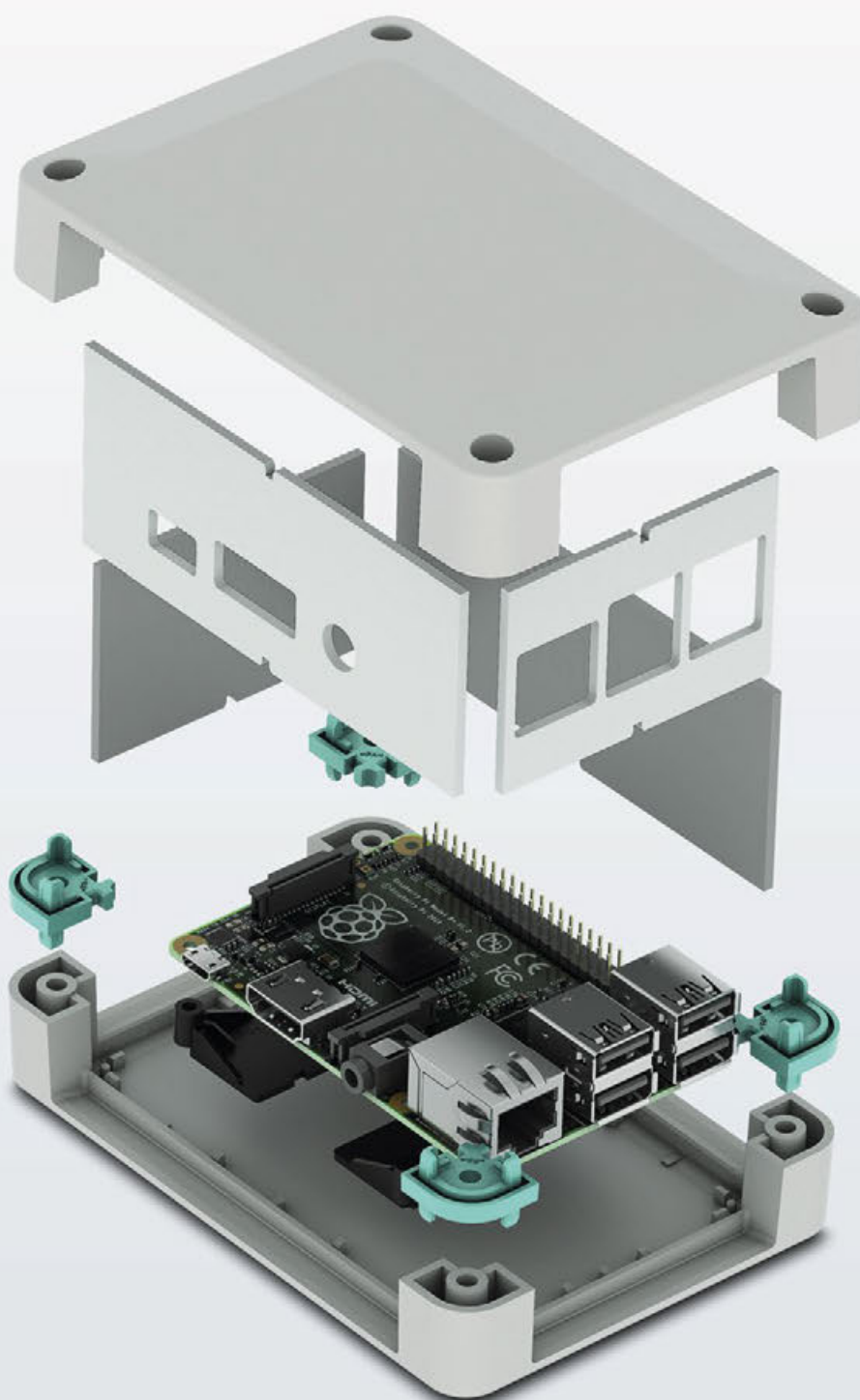

Raspberry Pi finds a new home

Versatile enclosure for Raspberry Pi B+

The new UCS-RPI Universal Case System for Raspberry Pi B+ has pre-milled side walls for easy access to the I/O and power inputs. It is available in black or grey, in two size configurations and with glue dot location posts to secure the single board computer to the case.

For additional information call 0845 881 2222 or visit
phoenixcontact.co.uk/RPIBC

magpi.cc/PDIDML

£15 / \$20



Maker Says

👉 NES case specifically designed for Raspberry Pi 3, 2, and B+
Kintaro

NES CASE

Rob Zwetsloot plays with power as he turns his Raspberry Pi into a mini NES with the Kintaro Entertainment System

Cases for the Raspberry Pi are a dime a dozen these days, so it's nice to see people selling fun themed cases for your Pi projects. It sets them apart from the myriad plastic, yet functional, cases for the Raspberry Pi.

The maker of this case, Kintaro, sells a couple of retro-console-themed cases. Along with this NES-inspired case, you can also get a (US purple) SNES-style case. The NES one is smaller and simpler than the SNES version, but still functions as a proper Raspberry Pi case.

Putting a Raspberry Pi in the case couldn't be easier – the two halves come unfastened in the box so you can separate the two. Inside you'll find four screws and a couple of heat sinks in bags which you'll need to remove. Place the Raspberry Pi inside the bottom half, replace the top half, and then use the provided screws to secure

the halves together from below. Job's a good 'un.

Flip the flap

While on the original NES the controller ports were located on the front of the machine, the USB ports on the Raspberry Pi aren't quite arranged like that. In a rather

ingenious move by Kintaro, the cartridge flap has been recreated on this case – simply flip it up to gain access to all the USB ports and the Ethernet port. Otherwise, all the important ports and slots are accessible while the Raspberry Pi is in the case, even the microSD slot. The case is really useful for using a Raspberry Pi as a standard computer or a retro gaming

“ Useful for using a Raspberry Pi as a standard computer or a retro gaming system ”

ingenious move by Kintaro, the cartridge flap has been recreated on this case – simply flip it up to gain access to all the USB ports and the Ethernet port. Otherwise, all the important ports and slots are accessible while the Raspberry Pi is in the case, even the microSD slot.

The case is really useful for using a Raspberry Pi as a standard computer or a retro gaming

Last word

A great, simple case that might be good for your home media setup if you're missing the elusive NES Classic Mini. Don't get it for hacky electronics projects, though.



Related

OFFICIAL RASPBERRY PI CASE

A more versatile case. While it does look cool, it may not quite be NES cool.



£6 / \$10

magpi.cc/ppUaBN

RASPBERRY PI BESTSELLERS

MANGA MATHEMATICS

No Starch's Manga guides use manga storytelling to make difficult subjects surprisingly approachable

THE MANGA GUIDE TO LINEAR ALGEBRA

Authors: Shin Takahashi
& Iroha Inoue

Publisher: No Starch

Price: £19.99

ISBN: 978-1593274139

magpi.cc/NGUfyX

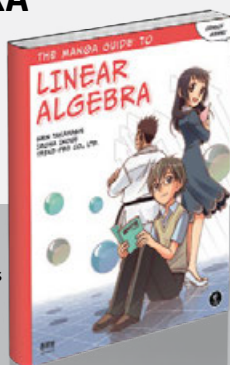

We all reach a stumbling point somewhere when learning maths. If linear algebra is yours, Takahashi's narrative-driven breakdown of the subject into small chunks and essential diversions will make several difficult concepts suddenly easy to understand.

THE MANGA GUIDE TO CALCULUS

Authors: Hiroyuki Kojima
& Shin Togami

Publisher: No Starch

Price: £15.99

ISBN: 978-1593271947

magpi.cc/moKUBC

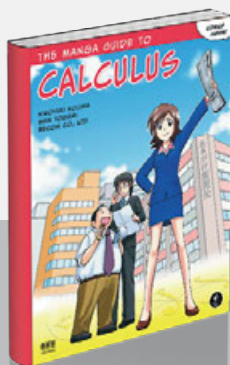

A lovely attempt at tying calculus into its real-world applications, from an economist with a strong appreciation of the subject. Perhaps best used in tandem with a dryer and deeper textbook or MOOC, but it will make either much clearer.

THE MANGA GUIDE TO REGRESSION ANALYSIS

Authors: Shin Takahashi
& Iroha Inoue

Publisher: No Starch

Price: £19.99

ISBN: 978-1593277284

magpi.cc/KobuGE

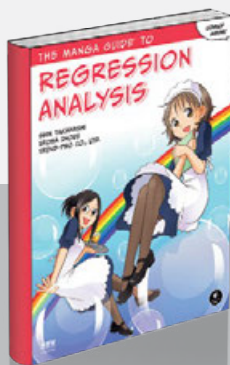

A well-chosen subject for a manga guide. If the level is not always perfectly judged, the overall result is still a fair understanding, with illustrated analogies often helping to clarify difficult concepts. Again, a good companion to more traditional learning.

CRACKING CODES WITH PYTHON

Author: Al Sweigart

Publisher: No Starch

Price: £25.50

ISBN: 978-1593278229

magpi.cc/WiQljD

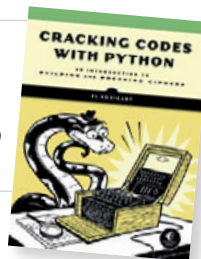

Yes! A book that teaches Python programming without games, but is still full of fun, intrigue, and playfulness. Along the way you'll also learn a lot about ciphers, encryption, and hacking – although little of the book deals with modern ciphers that are secure against the computational power that can be wielded against them, by working through centuries old ciphers you'll learn many of the principles behind today's encryption.

You'll also learn a lot of programming techniques, and the practical nuts and bolts of programming, from handling text, through loops, to functions, then

working up to more advanced Python topics. Python's strengths at data handling make this sort of thing fairly painless, and (relatively) few external libraries are needed, so the beginner can stay fairly focused on learning coding, not stacking together modules.

Complete code listings are given early in each cipher sample, growing longer with each chapter – these are well commented, and slowly broken down and examined, so the beginner need not feel too intimidated. Learning from working through longer listings is reminiscent of the 1980s, when magazines for the classic 8-bit computers carried long programs to type in. But never mind the nostalgia, it's a great way to learn – especially for adults and teens who aren't gripped by game coding.

Score ★★★★★

CLEAN C++

Author: Stephan Roth

Publisher: Apress

Price: £29.99

ISBN: 978-1484227923

magpi.cc/LKCOy

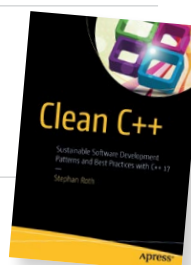

C++ projects seem more prone than most to delivering “fast and highly optimised [code], with a cruel syntax and ignoring elementary principles for good design and well-written code.” Roth brings all the best ideas of the Clean Code movement (clean code is easily understood and maintained, it's not about ‘beautiful code’), and the possibilities of this decade's improvements to the language.

Clean C++ delivers sound advice on testing; design principles (and software craftsmanship); clean code; object orientation; and design patterns. This is

not just a restatement of best practices laid down in many Java books, but as it goes from the general to the specific, the many C++ examples illustrate how relatively simple (and ultimately beneficial) it is to incorporate the practices into your own code. Roth is an opinionated commentator – but generally in a good way – and a knowledgeable and passionate proponent of best practices.

“Lots of C++ code that is written today looks like it was written in the 1980s,” says the blurb on the back of the book. All too true, sadly – but follow most of Roth's advice and you'll find that clean coding is not incompatible with C++. Everyone who has to work on your codebase – including the future you – will be grateful.

Score ★★★★★

PRACTICAL PYTHON DESIGN PATTERNS

Author: Wessel Badenhorst
Publisher: Apress
Price: £27.99
ISBN: 978-1484226797
magpi.cc/dVvkzoo

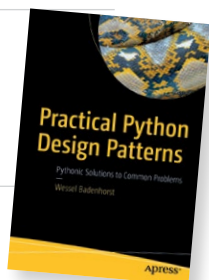

Badenhorst's mission is simply to make you a better programmer. To promote thinking at a higher level of abstraction, this book teaches Design Patterns – something that has become popular in particular in object-oriented languages from Java to Ruby. Beyond that, the author is keen for readers to emulate the practices of the best at the programming art, from deliberate practice and single focus, through systems thinking, to mastering tools, and looking at other frameworks, languages, and paradigms to see what there is to be learned.

Chapter one alone, containing advice on the above, would rapidly pay for the book's purchase by the improvements it will foster if the reader follows through with it – but the rest of the book deals concretely with design patterns, and Pythonic implementations of many of the most useful.

The chapters introduce a topic, and usually jump straight to a useful code snippet – such as implementing part of a real-time strategy game for the prototype pattern chapter – before outlining the problem to be solved by the pattern, then taking the reader down whichever path best advances understanding. As do the 'parting shots', and a series of exercises, at the end of each chapter. A good and useful read.

Score ★★★★★

PRODUCT ROADMAPS RELAUNCHED

Authors: C. Todd Lombardo, Bruce McCarthy, Evan Ryan, & Michael Connors
Publisher: O'Reilly
Price: £27.99
ISBN: 978-1491971727
magpi.cc/AKZhOp



What is a product roadmap? An out-of-date listing of deliverables? A best-fit compromise that doesn't really satisfy any of your stakeholders? A source of contention within your organisation? A bright shiny vision of the future that your customers don't trust? Roadmaps have failed to keep up with agile development, and are often mired in detail best put in a project plan.

Product Roadmaps Relunched takes a fresh look, removing focus from deliverables, and looking at the why. Where's the product going – not in set-in-stone phases of promised

deliverables, but in terms of your organisation's values, and where you want to make life better for your customers?

If this all sounds a little vague, good. A roadmap is a strategic document, not a product plan. To make it more concrete, the book moves from the why to the how – to make a flexible roadmap that can be shared

with your customers, without promising anything that would skew the product away from where it should be going. This product we talk of could be an IoT project, app, or website – but the advice carries over into many other fields. A thoughtful and thought-provoking re-examination of one of the fundamentals of building a successful IT company.

Score ★★★★★

ESSENTIAL READING: SCRATCH

The fun and easy way to start kids coding, a visual language more powerful than it seems.

Scratch Website

Author: MIT
Publisher: MIT
Price: Free download
magpi.cc/sjNTTS



Naturally, the Scratch website has plenty of resources to start your kids learning, from free PDF guides to Scratch Cards.

Super Scratch Programming Adventure!

Author: The LEAD Project
Publisher: No Starch
Price: £19.99
ISBN: 978-1593275310
magpi.cc/kmwfvi



For confident younger learners, this concise, comic-style introduction provides a quick introduction, and lets your kids make some great games.

Scratch for Kids for Dummies

Author: Derek Breen
Publisher: Wiley
Price: £21.99
ISBN: 978-1119014874
magpi.cc/TCyZow

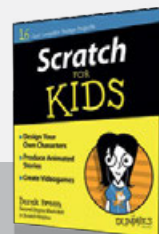

Not in any way dumbed down – a brilliant guide to sprites, animations, comics, programming, and plenty of games. And really good fun.

Learn to Program with Scratch

Author: Majed Marji
Publisher: No Starch
Price: £27.99
ISBN: 978-1593275433
magpi.cc/KjPpaU



Truly excellent introduction to more formal programming concepts, using Scratch, for beginners or experienced Scratchers.

Cool Scratch Projects in easy steps

Author: Sean McManus
Publisher: In Easy Steps
Price: £10.99
ISBN: 978-1840787146
magpi.cc/2me3yQu



Magic Mirror, 3D effects, using the Raspberry Pi's Camera Module – there's plenty here for any Scratch learner to move onto as the next step.



BUILD A COMPUTER

FOLLOW MISSIONS

LEARN PROGRAMMING

PIPER COMPUTER KIT

Educational Computer that teaches STEM and Coding

Kids build their first real computer then advance through Piper's award-winning story-based curriculum and learn physical engineering and electronics in the process.

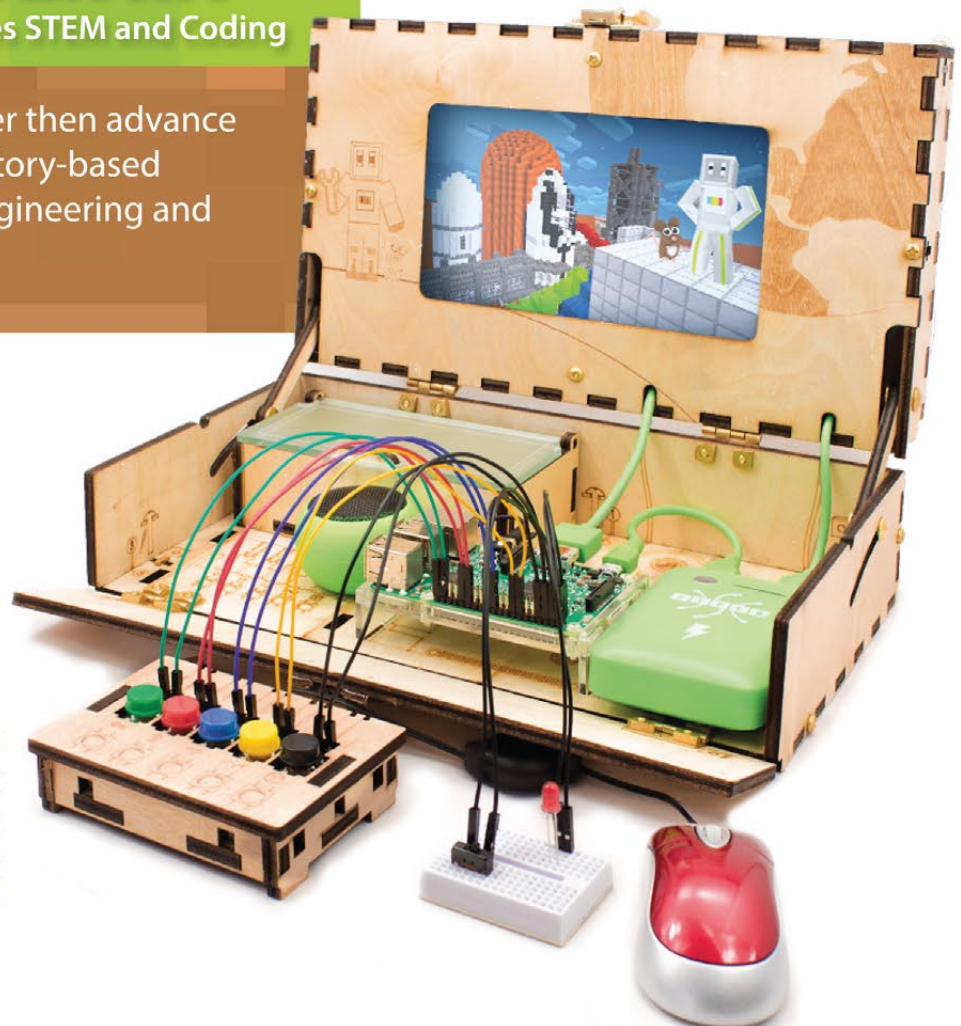

Special \$10 MagPi coupon:

MagPiSummer

only at BuildPiper.com



"It's a really fun educational computer kit that should really impress those who love Minecraft and building stuff" **The MagPi**

A STEM SOLUTION FOR SCHOOLS

Teachers all over the world use Piper to inspire kids to program, design, and engineer.

Want to learn how to bring Piper to your school?
buildpiper.com/EDU

THE PIPER EXPERIENCE



BUILD FROM SCRATCH



SOFTWARE-BASED CURRICULUM



CREATE YOUR ELECTRONICS



Supported by Top University Funds
Stanford-StartX Fund
AEF of Princeton University

Available at:



BuildPiper.com

amazon

ToysRUs

BARNES & NOBLE

MAKING MUSIC WITH A RASPBERRY PI

The album *RPi ZWEI* was created using just a Raspberry Pi 2



Yerzmyey

Occupation: Musician

Making music on a Raspberry Pi is simple enough thanks to Sonic Pi. However, demoscene musician Yerzmyey decided to go one step further and make an entire album using the Raspberry Pi as his instrument. You can listen to *RPi ZWEI* here while you read through our interview with him: magpi.cc/WhckCf.

Tell us about your album! What kind of music would you say it is?

Typical demoscene music is usually divided in two basic types: chiptunes and modules. Generally we might say that chiptune music is usually synthetic and full modules – like MOD, S3M, XM, etc. – are sample-based.

The songs on my Raspberry Pi album are modules – the XM modules to be exact – made with a Raspberry Pi 2 and MilkyTracker working on the regular Raspbian system.

In general you can find all kinds of electronic music, although every song is different: from electro/ techno-pop, through Eurodance, to instrumental electronica [a bit like] Mike Oldfield. It then ends in a chiptune style with BitPusher2600's remix made on the Pi.

Why a Raspberry Pi?

I bought one when the Pi 2 was still the new model. However, my decision back then was motivated directly by the announcement that the Raspberry Pi outsold the ZX Spectrum. I thought, "Aha! I have to get one NOW!" The Raspberry Pi, being a British computer, is important to me as I've been a ZX Spectrum fan and user since the eighties.

The Pi is a modern, and potent, machine. Obviously, it's not old school, but you can feel some cool old-school philosophy behind it.

The entire idea of the project was to use only Pi 2 and nothing else. I composed this music on the Pi and then recorded it all directly from the headphone output of the board.

The Pi 2 is powerful so the songs can be complicated and use multichannel, which makes for a great tune for the listener. The most complex song on the album consists of 26 independent channels of digi-music. The Pi can surely manage more, but that wasn't the point of this album.

How did you go about composing the album?

I programmed all notes one-by-one, as is customary on the music trackers. You have to put all the notes/sounds in manually without any automatic help. Otherwise I use loops, but only when it comes to drum 'n' bass music (drum loops are indispensable there) or when I



Above Yerzmyey has played music all over the world – including Japan



play the guitar (or ask some friends to do it for me; I'm not a very good guitarist). I cut these recorded guitars into loops and put them into the song/module in a form of WAV files. Of course, the multilayer technique is useful there too, so I can 'play simultaneously' on many guitars.

My weapon of choice on the Raspberry Pi is MilkyTracker, a familiar and powerful tool. Of course the Pi can do a lot, so for example one can use emulators or cross-platform trackers to make chiptune music too. I tested how the SID chip emulation works on the Pi 2, with the GoatTracker, and it is really nice: magpi.cc/lrJKai.

There's other software of course; for instance, there is Unreal Speccy Emulator for ZX/AY lovers and so on. There's also really complex software-synthesizers that you can use – you can find out more info about them here: magpi.cc/YUXfeE.

Do you have a background in chiptune music?

For chiptune stuff I mostly use a ZX Spectrum 48K with AY-interface, although when I started in the late eighties, there was only BEEPER accessible, so initially I was making

1-bit music on 'Wham! The Music Box' and after that I changed to SoundTracker 1.1 and the AY chip.

Since then I've made music for over 60 games, mostly for ZX Spectrum; sometimes with such distinguished ZX game-developers like Jonathan Cauldwell – and many other, equally talented friends.

I participated in making numerous demos for Spectrum and Atari ST – and played many chiptune concerts in various places on planet Earth.

How long have you been making music?

I remember making songs for our group's first demos and games in 1987 – games like Ghost Eater (1987) and Hunting (1988) – but I don't think they exist any more (everything was recorded on tapes in those days) so the earliest demo I still have containing my chiptune attempts comes from 1989 and my first game music (a text adventure) comes from 1993.

Have you used the Raspberry Pi for anything else?

Like I mentioned before, the Pi is a powerful machine so I use it for literally everything. It's as useful as any other modern computer (not to

Above Made on a Pi 2, the *RPI ZWEI* mini album features five tracks

mention it's much cheaper, smaller, cuter, and far more portable).

Text editing, spreadsheets, internet with YouTube included, music listening, watching movies, and stuff like that. I also do a lot of gaming, mostly using RetroPie.

I have my PC and the Pi permanently connected into one switchable monitor so I don't have to buy a second PC, as the Pi is totally enough. Ten years ago this was unthinkable. They weren't called towers for nothing.

Do you plan on making more music with Raspberry Pi?

Actually I do. Of course, every time I try to make some new stuff, so this time I was considering buying and using the Raspberry Pi Zero for a change. A smaller machine, more limited – it might be interesting. I will try, presumably.

Another thing would be to make something for the Pi 3, but it's so powerful that probably I would have to make – I don't know – some symphonic music on it? Which might be tricky because last time I tried that was in the '90s. Also, trackers aren't very good for this particular kind of music (MIDI is better here). But we will see. Or hear.

THE MONTH IN RASPBERRY PI

Everything else that happened this month in the world of Raspberry Pi

BIG BIRTHDAY WEEKEND!

OVER 100 JAMS CELEBRATED RASPBERRY PI'S SIXTH BIRTHDAY!

Celebrations for the Raspberry Pi's birthday have been getting bigger every year, and this year was the biggest yet! Over 100 Jams around the world organised a special event to honour the Raspberry Pi on its sixth birthday, and even despite the snow in the UK, the world was abuzz with Pi love.

Edinburg, TX, USA
This South Texas Jam couldn't escape the fun of the photo booth either

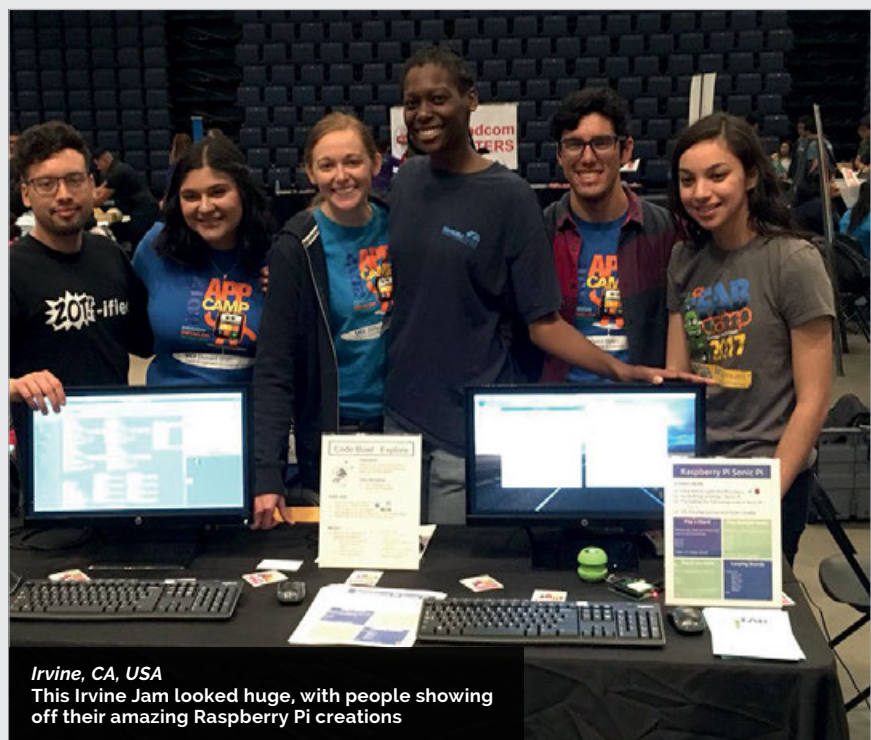
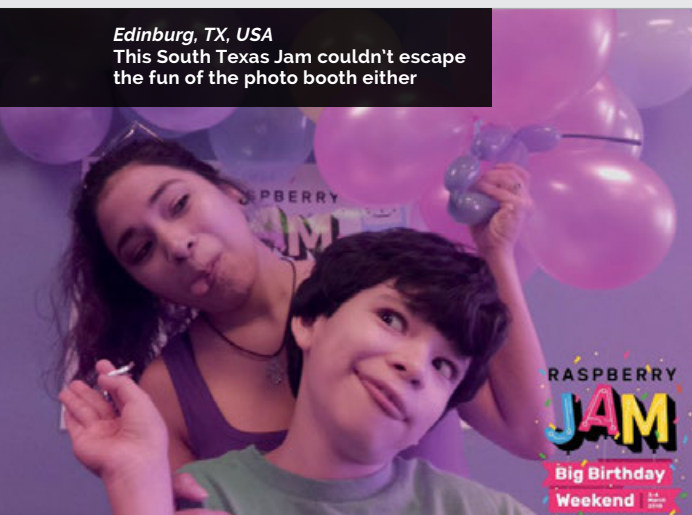

Irvine, CA, USA
This Irvine Jam looked huge, with people showing off their amazing Raspberry Pi creations

Cotswold Jam
This impressive beast was edible, and 60 cm long!



Raleigh, NC, USA
We saw many cakes coming from Pi parties; this amazing cupcake delicacy hailed straight from North Carolina

Lagos, Nigeria
While fun, some serious learning went down at the party Jams



Tokyo, Japan
The photo booth project made for Pi parties was a huge hit around the world!



Southend, UK
This one was a bit closer to home as young makers got to grips with the Sense HAT



SNOWED IN!

Unfortunately, a few Jams had to be postponed due to the ridiculous snow the UK experienced in March. Many Jams will be rescheduling though, so keep an eye on your email and social media feeds!



India
Hacking about with Raspberry Pis under a very fetching blue light in India

RASPBERRY PI 3B+ IS HERE!

The community reacts to the latest version of the Raspberry Pi

A new Raspberry Pi is always cause for a mini-celebration, even if we've just celebrated a birthday! Launched on Pi Day (14 March or, in American notation, 3/14) the Raspberry Pi 3B+ is the ultimate version of Raspberry Pi 3. Here are some of the reactions from the community to the news...

Want to learn more about the Pi 3B+?

Check out our launch video: magpi.cc/GqePcN

Tanya Fish @tanurai
Happy Pi Day, people! New @Raspberry_Pi 3B+ is out.

Self-expression can take many forms, including excellent Raspberry Pi nail art. The glittery green nail polish is also impressive

B Rev 1, B Rev 1 links, A, B Rev 2 (China), B Rev 2.1 (UK), B Rev 2 (c), Compute Module, B+, B+ (Chinese), A+, 2B, Zero 1.2, 3B, A+ 512, 2B 1.2, Zero 1.3, 3B (Japanese), 3B (Brazilian), Zero W, Compute Module 3, 3B+, Raspberry Pi

Alex Eames of RasPi.TV always updates his 'Pi family' image whenever a new model is released. It now includes Brazilian and Japanese Pi boards, too!

FOR YOUR VIEWING PLEASURE

Here are some great videos about the new Raspberry Pi!

magpi.cc/IfxRwR

NEW RASPBERRY PI 3B+ REVIEW AND SPEED TESTS

Estefannie takes us through the differences between the original Raspberry Pi 3 and the 3B+, including networking and processing speed. It's also a mad video.

magpi.cc/XzjWXI

RASPBERRY PI 3 MODEL B+

Here's a gorgeous little stop-motion animation to herald the arrival of the wee wonder, directed by Tom Sutherland and friends, as a teaser for the release.

magpi.cc/msQxvm

raspberrypi Pi 3 Model B+

INTRODUCING THE RASPBERRY PI 3 MODEL B+

Eben Upton talks to Roger Thornton, Principal Hardware Engineer, about what's new with the Pi 3B+ in this very informative video.

KICKSTART THIS!

Raspberry Pi projects you can crowdfund this month

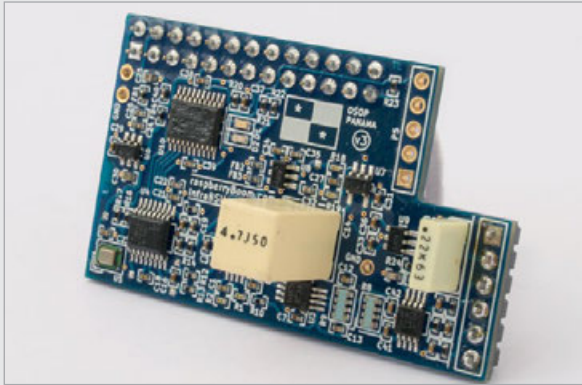

RASPBERRY BOOM

magpi.cc/bkCCdB

Remember the Raspberry Shake? Well, the team behind the seismograph HAT for the Pi are now crowdfunding a new citizen science add-on with the Raspberry Boom. The Boom detects low-frequency sounds that the human ear cannot hear, and a network of these can help detect and pinpoint a huge number of terrestrial and extra-terrestrial phenomena that would otherwise go unnoticed.

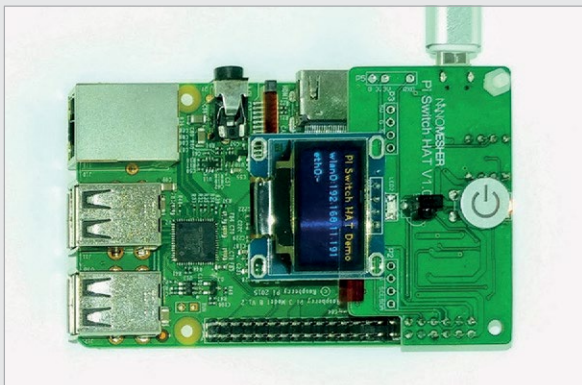

HACKABLE RASPBERRY PI SWITCH HAT

kck.st/2FHoNmk

Nanomesher is back to crowdfunding with a new Switch HAT, improving on the design of the original that we liked so much. It fixes one of our biggest concerns with it, the use of jumper cables to connect everything. There's also additional remote support so you can use it with Kodi – this is probably going to be a bit of a game-changer!

BEST OF THE REST

Here are some other great things we saw this month

KITCHEN INFOBOARD

Infoboards seem to be the new hotness over on the Raspberry Pi subreddit – sort of like a magic mirror but without the mirror part. A screen you can check at any time for info. This version we quite like as it doubles as an automated, voice-controlled kitchen assistant. Handy!

imgur.com/a/pWrXI

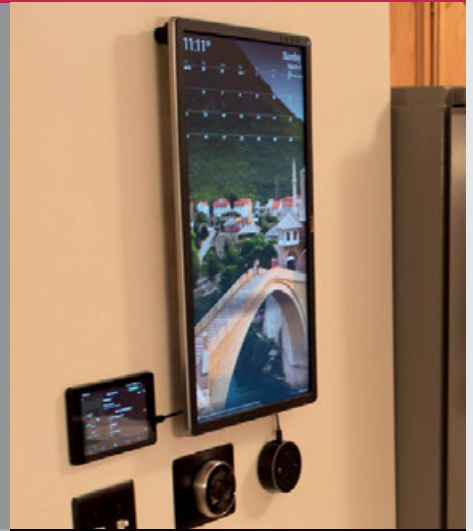

PARTICLE GENERATOR

Unfortunately, the image here doesn't do it justice – this series of 32x32 RGB LED panels creates a truly stunning particle generation effect. We can see this being repurposed for holiday decorations as well.

magpi.cc/QZTsox

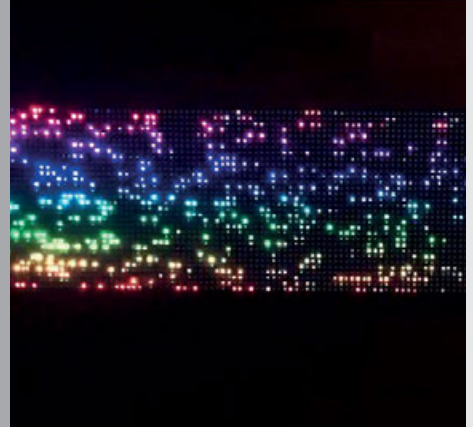

CASSETTE GAMES CONSOLE

Following the trend of putting a Raspberry Pi in something a bit retro, here's a cassette tape with a Pi Zero inside. It's being used as a games console. We especially love the marker pen on the label to give it that authentic mix-tape feel.

magpi.cc/vxhcQy





COMMUNITY PROFILE

AMANDA HAUGHS

Meet Amanda, US-based teacher, Raspberry Pi Certified Educator, and maker of things

Amanda

Category: Educator

Day job: Digital Innovation ToSA

Website: twitter.com/mshaughs
magpi.cc/hGVavU

Below Amanda works as teacher on special assignment within her school district to support educators in broadening computer-science skills through cross-curricular experiences

Below right Amanda joined Raspberry Pi Foundation staff members Carrie Anne Philbin and James Robinson, alongside fellow Picademy alumnus Nicholas Provenzano, on the Digital Making with Raspberry Pi panel at ISTE 2017

Amanda Haughs works as the Digital Innovation teacher on special assignment (ToSA) for Campbell Union School District in San Jose, California. Within the role, she works to support teachers in engaging their students, exploring how to create “meaningful and relevant cross-curricular learning experiences.”

On her website, Amanda describes herself as “passionate about the integration of technology and computer science education in elementary classrooms to support the development of creativity, critical thinking, and problem-solving skills in students.” And with her continued efforts to create content such as her STEAM and CS

Lesson Resources, and fun projects at home, she’s on the right track to be making a big difference, both in her district and across the USA.

Amanda took part in the second Picademy cohort to run in North America. Picademy, the two-day training course run by the Raspberry Pi Foundation, provides free professional development for educators, both in the UK and North America. A week after the event, as Amanda recounted her experience on her blog, she was quick to admit that her head was “still spinning with all the Raspberry Pi goodness” she was able to obtain over the weekend, and she has since gone on to help in further sessions of the training across the country.



HIGHLIGHTS



In her role as Digital Innovation ToSA, Amanda works with schools and educators within San Jose's Campbell Union School District, supporting cross-curricular learning

More recently, Amanda has continued to integrate the use of Raspberry Pi into the classroom, working alongside fellow ToSA Misty Kluesner to create multimedia art projects based on the theme of Awe and Wonder, and the Aurora Borealis. This exploration took the coding practice of computing classes into the arts sector of the school, putting the A in STEAM where we are beginning to see more and more examples of code in art and design.

way to incorporate the use of my grandmother's hi-tech embroidery machine," she explains in her blog post for the project. "Right away I thought it would be fun to embroider the Raspberry Pi logo and from there I realised that a tote bag would be the way to go for my first wearable project."

The result was a tote bag made from scratch that included the Raspberry Pi logo and programmable LED lights. With the conductive thread making up

“ Right away I thought it would be fun to embroider the Raspberry Pi logo

Outside of her work in education, Amanda is a tinkerer. While planning her attendance to multiple education-based conferences and events in 2017, she decided to stand apart from the crowd by integrating a Raspberry Pi-powered wearable into her wardrobe. While many wearables hide their circuits behind folds of fabric, Amanda decided to celebrate hers by using conductive thread and her grandmother's programmable sewing machine. "I loved the idea of making something wearable and blinky, and also wanted to figure out a

the outline for the logo, the LEDs were connected to a Raspberry Pi Zero, and code controlled how and when they blinked as she walked from booth to booth at ITSE 2017, among other events.

In 2015, she was awarded the PBS Digital Innovator Award, and followed this up in 2016 with the SVCUA Outstanding Teacher Award. With her Raspberry Pi Certified Educator pin to boot, Amanda continues to work hard, gaining more recognition along the way, and the North American Raspberry Pi community is proud to have her on board.



magpi.cc/WxKuaD

STEAM AND CS LESSON RESOURCES

Amanda has created a pack of project resources to aid educators in introducing cross-curricular coding into the classroom within her district. Once news of them made its way to Twitter, educators across North America were adding them to their classroom toolkit.



magpi.cc/nikZJv

RASPBERRY PI TOTE BAG

While planning her trips to educational conferences and events in 2017, Amanda decided to create something eye-catching and a little different. With a little help from her sewing machine-ninja grandmother, she created the flashing LED Pi Tote.



magpi.cc/OcglQP

RASPBERRY PI CERTIFIED EDUCATOR

Amanda attended Picademy in California, 2016, becoming one of over 400 Raspberry Pi Certified Educators (RCEs) so far trained in North America. With her Picademy pin in hand, she went on to help the Raspberry Pi North America team train more RCEs at future events.

RASPBERRY JAM EVENT CALENDAR

Find out what community-organised, Raspberry Pi-themed events are happening near you...

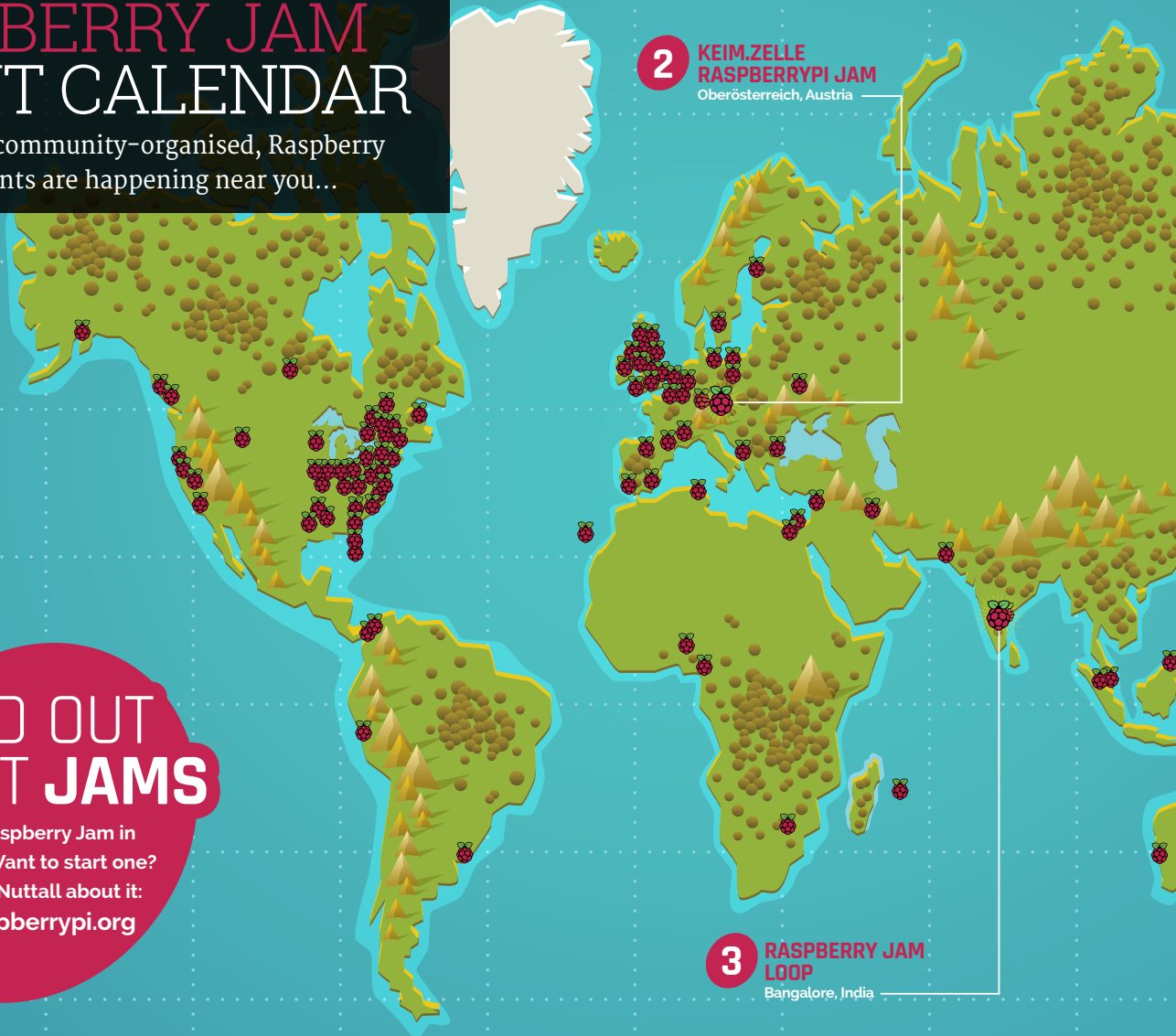

2 KEIM.ZELLE
RASPBERRYPI JAM
Oberösterreich, Austria

3 RASPBERRY JAM
LOOP
Bangalore, India

FIND OUT ABOUT JAMS

Want a Raspberry Jam in your area? Want to start one? Email Ben Nuttall about it: ben@raspberrypi.org



HIGHLIGHTED EVENTS

1 PI JAM!

When: Thursday 5 April
Where: Fab Lab Limerick, Limerick, Ireland
magpi.cc/puDvRT

A belated Big Birthday Jam will be taking place in Limerick, with show-and-tell presentations, demos, and workshops.

3 RASPBERRY JAM LOOP

When: Saturday 14 April
Where: Bangalore, India
magpi.cc/fNBYEa

Are you that person who loves all 'tech stuff'? Then get over to Raspberry Jam LOOP to learn about it!

2 KEIM.ZELLE RASPBERRYPI JAM

When: Saturday 7 April
Where: Lichtenberger Strasse 3, Oberösterreich, Austria
magpi.cc/jejESY

Programming sessions for children and parents, explained step-by-step so that you can work at it together.

4 PI WARS 2018

When: Saturday 21 April
Where: Cambridge Computer Lab, Cambridge, UK
piwars.org

The big moment is here: Raspberry Pi robots duke it out in non-destructive challenges to find out which is the best automaton.

REGULAR EVENTS

5 PRESTON RASPBERRY JAM

When: Monday 2 April
Where: Media Factory Building, Preston, UK
magpi.cc/CbQdLN

PRJ is a community of people who meet in Preston each month to learn, create, and share the potential of Raspberry Pi.

6 CORNWALL TECH JAM

When: Saturday 14 April
Where: Cornwall College, Camborne, UK
cornwalltechjam.uk

Learn about coding on a variety of platforms, including Arduino and Raspberry Pi, in various programming languages.



WE'VE HIGHLIGHTED SOME OF THE AREAS IN NEED OF A JAM!
CAN YOU HELP OUT?



8 LEEDS RASPBERRY JAM
Leeds, UK

5 PRESTON RASPBERRY JAM
Preston, UK

1 PI JAM!
Fab Lab, Limerick

4 PI WARS 2018
Cambridge, UK

7 EGHAM RASPBERRY JAM
Staines-upon-Thames, UK

6 CORNWALL TECH JAM
Camborne, UK

EGHAM RASPBERRY JAM

When: Sunday 29 April

Where: Gartner UK HQ,
Staines-upon-Thames, UK
magpi.cc/stflbP

Primarily a show-and-tell event where people bring along their projects for others to try out and learn from.

7

LEEDS RASPBERRY JAM

When: Wednesday 2 May

Where: Swallow Hill Community
College, Leeds, UK
magpi.cc/Hdaalj

There will be chances to get hands-on with digital making activities through the workshop, and a hackspace area to share projects.

8

RASPBERRY JAM ADVICE:

WHAT TO DO

“When I ran the Manchester Jam, people were happy to work on their own projects. Occasionally we ran a track of talks, or put on a workshop, which was a nice change. Now I run the Jam at Pi Towers, the attendees tended to be mostly beginners – usually parents with their children – so we mostly run workshops and hand out worksheets.”

Ben Nuttall
Raspberry Jam @ Pi Towers

Every Raspberry Jam is entitled to apply for a Jam starter kit, which includes magazine issues, printed worksheets, stickers, flyers, and more. Get the guidebook here: magpi.cc/2q9DHfQ



YOUR LETTERS

CATALOGUING OLD ISSUES

I'm a little bit of a latecomer in the area of trying to read all the old issues of *The MagPi*. It's a tedious task and I have not found a place with a list of all the contents. I tried to copy-paste them from each magazine but have not quite succeeded. For some reason, some of the magazine contents can be copied in a reasonable manner whereas some cannot – usually requiring some editing.

Is there a catalogue and if not could you please make one?

Jukka Salo

Thanks for having a go – unfortunately it's a bit of a big task! We think the best way to get a good highlight of projects and tutorials and reviews is to check out the Official Projects Books that we release every year. The best of the best make it into these books, which have a comprehensive contents section as well!

If anyone has started to create a catalogue of all our contents, though, please let us know! We'd be happy to host it on our GitHub repo and maintain it diligently.



Get an excellent selection of projects and articles the easy way with our Official Projects Books!

RETRO COMPUTING

I love the idea, and have long wanted to do a RetroPie but... years back I ran Sinclair QLs, and managed to get the game Stellaris, a strategy game, keyed in (laboriously, QL SuperBASIC). This was at a time when storage was by tape, basically a cassette recording of the tones of the phone-line modems of the day (perhaps 9600 bits per second – a generous estimate, and yes, bits!), and before that degraded too far I got it over to a 720kB floppy disk.

The keyboards failed and I abandoned them. Meanwhile I had already progressed through IBMs: PC (180kB 5-inch floppy), extender board, XT (360kB floppy), extended to 640kB, 286sx (a rarity – basically an XT with a 286 processor), 286, 386 (720kB floppy, but couldn't read the QL disks :(), a brief fling with Acorn Electron, 486 (1.44MB floppy!), Pentium, discovered

Linux (Slackware!) and onward... meanwhile the QLs (and monitors and floppies) sat in storage.

Now running a Core i3 with Kubuntu and a Pi 3, with a Pi sitting unused, I thought 'why not a RetroPie?' I dug out the QL magazine (QL World, June 1987) and OCR'd the Stellaris program (*much easier than typing it all!*), ending up with a 36kB text file that includes the author's player instructions... and then tried to find a QL emulator. RetroPie doesn't have one.

I think there's one in Windows' 'DOS box' system, but IIRC (it was long ago) I gave up trying to get it to run. Long and short: is there a QL emulator for the Pi (or other Linux), or is there someone adept at translation that could/would translate the QL SuperBASIC into something that could run on the Pi? As I read it, it's rife with text boxes spread around the screen, and of course the screen geometry is all sorts of strange. **Dexter N Muir**

RASPBERRY PI DESKTOP

I understand there is a disc which I can put into my PC that contains the Raspberry Pi Desktop for PC?

I was told that there was a copy in your magazine which would provide me with instructions as well as the disc – what's the situation on getting a copy if this is available?

I'm very keen to get my teeth into this and start learning some new skills. Hopefully you can help me. **Paul**

We've released a disc with the Raspberry Pi Desktop on it a couple of times in the past. However, the easiest way to get it if you can't find a copy is to download it and put it on a USB stick – you can find the downloadable ISO here: magpi.cc/Tdctna.

From there you can use something like Rufu (rufus.akeo.ie) to create a bootable USB stick, and then just follow our video on how to install it: magpi.cc/DEOVGR. It's really that easy!



Keep an eye out for when we put a disc on the cover – it tends to coincide with major updates to Raspberry Pi Desktop x86!

Unfortunately we don't have a direct answer for you, Dexter, and some of the emulators we tried to Google don't all seem to be maintained very well. Hopefully one of our intrepid readers will get in touch and we can sort out some kind of solution and get back to you!

Digital preservation is an important field at the moment, especially with games and computer systems slowly dying without much fanfare. Maybe this could be a step towards saving more old tech?



FROM THE FORUM:

HACKSPACE

MAGAZINE DISCOUNTS

The Raspberry Pi Forum is a hotbed of conversations and problem-solving for the community – join in via raspberrypi.org/forums

Is the discount still available for *The MagPi* subscribers for HackSpace magazine? I didn't subscribe early as I wanted to make sure the content was consistently good and not just for the first couple of issues.

LouisP

If you're a year-long subscriber to *The MagPi*, your discount code for HackSpace magazine shouldn't expire. We had some problems with the original discount code being leaked, though, so if you're having trouble sorting out your discount, please drop us a line and we can try to sort it out.



DINrPlate™

The simple way to mount your Pi!

- Industrial DIN rail mount
- Open frame for better airflow
- Integrated USB strain relief



www.DINrPlate.com

WRITE TO US

Have you got something you'd like to say?

Get in touch via magpi@raspberrypi.org or on The MagPi section of the forum at: raspberrypi.org/forums

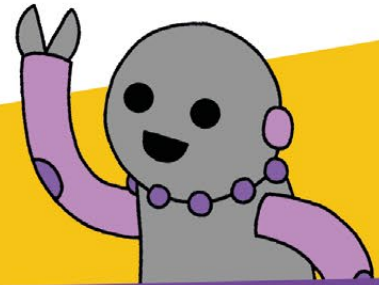
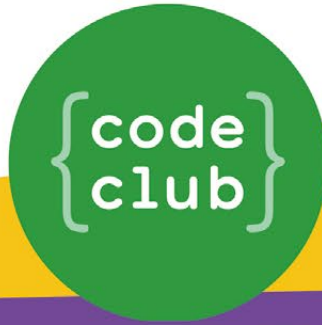

START A CODE CLUB IN YOUR SCHOOL!

Code Club is a network of volunteers and educators who run free coding clubs for young people aged 9-13.

Our aim is to inspire the next generation to get excited about computer science and digital making.



"We use Code Club's fun educational resources to run a weekly after-school club for Year 7 and Year 8 pupils. The students benefit considerably from the extra challenge!"

Karen Dadd, Computing Teacher

- Code Club is free
- Code Club provides step-by-step guides for Scratch, Python, HTML, and Sonic Pi
- Code Club helps children develop skills including logical thinking, creativity, and resilience



We have over 6000 clubs across the UK teaching more than 80,000 young people to code—come and join us!

Find out more at www.codeclub.org.uk



IN ASSOCIATION WITH:

 **Mime
Industries**

WIN! 10 MEARM PI KITS

We've teamed up with Mime Industries to offer ten of these fantastic robot arm kits for Raspberry Pi.

We reviewed the MeArm Pi in issue #62 and found it "a joy to build and use". You can control the MeArm Pi using the twin joysticks, or with code.

Maker Says

“The MeArm Pi is an easy-to-build robot arm kit that's designed to get children (and adults!) learning about technology, engineering, and programming.”

Mime Industries



Enter **now** at magpi.cc/win

Learn more:
shop.mime.co.uk

Terms & Conditions

Competition opens on **28 March 2018** and closes on **19 April 2018**. Prize is offered to participants worldwide aged 13 or over, except employees of the Raspberry Pi Foundation, the prize supplier, their families or friends. Winners will be notified by email no more than 30 days after the competition closes. By entering the competition, the winner consents to any publicity generated from the competition, in print and online. Participants agree to receive occasional newsletters from The MagPi magazine. We don't like spam: participants' details will remain strictly confidential and won't be shared with third parties. Prizes are non-negotiable and no cash alternative will be offered. This promotion is in no way sponsored, endorsed or administered by, or associated with, Instagram or Facebook.

MATT RICHARDSON

Matt Richardson is the Executive Director of the Raspberry Pi Foundation North America and author of *Getting Started with Raspberry Pi*. Contact him on Twitter @MattRichardson.



CHEERS TO THE COMMUNITY

Matt Richardson's take on ensuring community growth for years to come

Just a few weeks ago we celebrated the sixth birthday of Raspberry Pi. To mark the occasion, there were 'Big Birthday Weekend' Raspberry Jams all over the world. They took place at Raspberry Pi's birthplace Cambridge, to my home town Philadelphia, all the way to Tokyo, and pretty much everywhere in between.

Watching these worldwide Jams on Twitter was incredible and a reminder of how large, how widespread, and how enthusiastic the Raspberry Pi community is. The success of the Raspberry Pi over the last six years is due in

“ We owe so much of the success of Raspberry Pi to the amazing community around it

very large part to this community, which includes makers, developers, educators, tech geeks, engineers, gamers, artists, and many more.

We're a diverse group of people and we're all over the globe. But we have something in common. We know that affordable and accessible technology like Raspberry Pi is a powerful force in the world. Raspberry Pi brings computing and digital making to more people so that they can solve problems, express themselves, and have fun.

Get Jammin'

There are some ways that all of us can ensure that this valuable community is growing and can sustain itself for many years ahead. First, if there's a Jam happening near you, all you have to do is show up. Even if you don't have anything to share, it's a great opportunity to show your support and meet other community members. Even better, you can offer help to your local Jam organiser. Having a team of collaborators working on a Jam instead

of a single individual makes a huge difference in the quality and sustainability of a recurring event like a Jam.

If you don't have a Jam near you, you can start one. You don't need permission from us, but if you register your Jam, we can put it on the Jam map and make sure that other Raspberry Pi community members know about it. Don't be intimidated by the big Jams you may have seen online or in *The MagPi*. A Jam often starts with just a few people getting together on a regular basis to share the projects they're making with Raspberry Pi.

Join the forum

Another way to support the Raspberry Pi community is to participate in the forum: raspberrypi.org/forums. Whether you're sharing a project you made, asking questions, providing guidance to others,

or just chatting in the off-topic area, it's such a great way for our community to stay connected. And with over a million posts, the forum has become a massive knowledge base.

The Raspberry Pi is a computer made for making. So sharing what you create with Raspberry Pi is a great way to recruit new members to join our community. Part of this is just showing off what Raspberry Pi is capable of. And if you're sharing the steps to how you made your project, you're contributing to the wealth of online knowledge about Raspberry Pi in addition to empowering others to make.

We owe so much of the success of Raspberry Pi and the Raspberry Pi Foundation to the amazing community around it. When you participate in the community by going to Jams, engaging in the forums, and sharing what you make, you're helping to make sure that it will be around for a long time. Here's to another six years of this kick-ass community!

THE *Official*

RASPBERRY PI BEGINNER'S BOOK

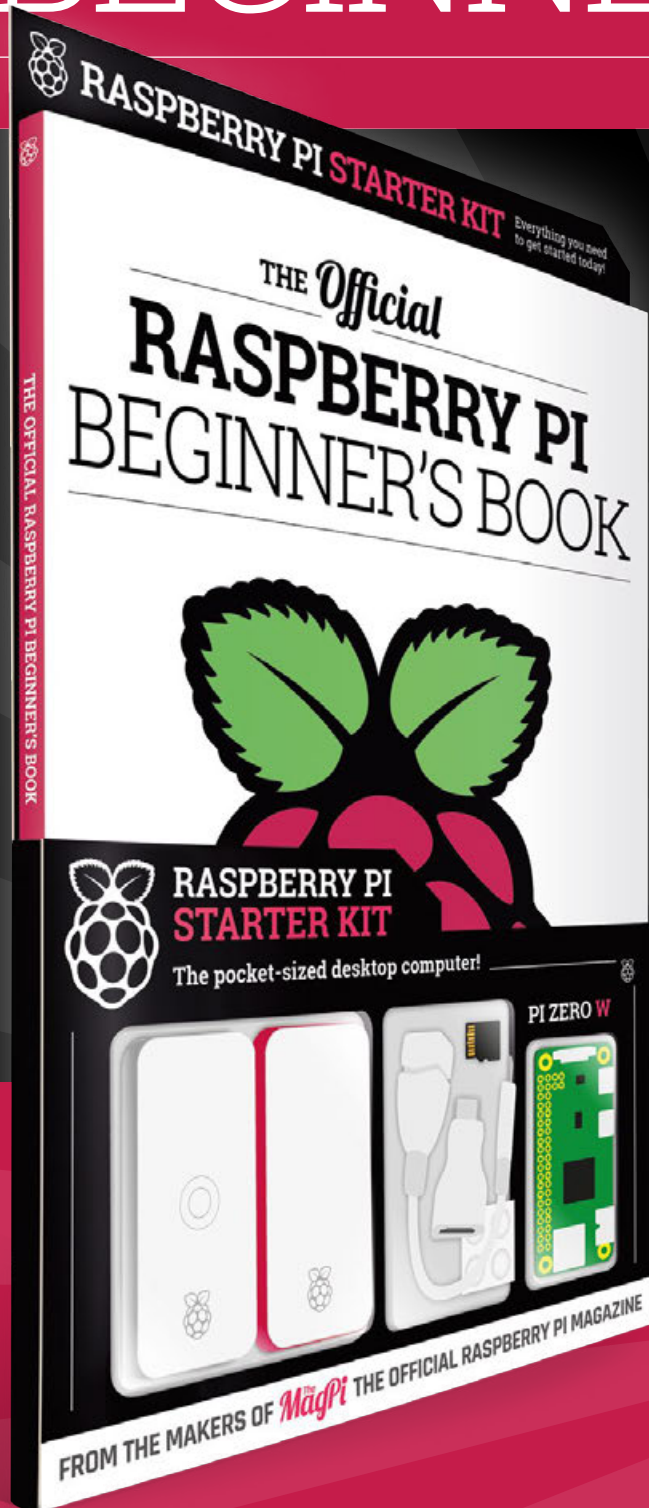

**LEARN
COMPUTING
THE EASY WAY!**

Includes

- Pi Zero W computer
- Official case with three covers
- USB and HDMI adaptors
- 8GB Micro SD card
- 116-page beginner's book

*Available
now*



Buy online: magpi.cc/store

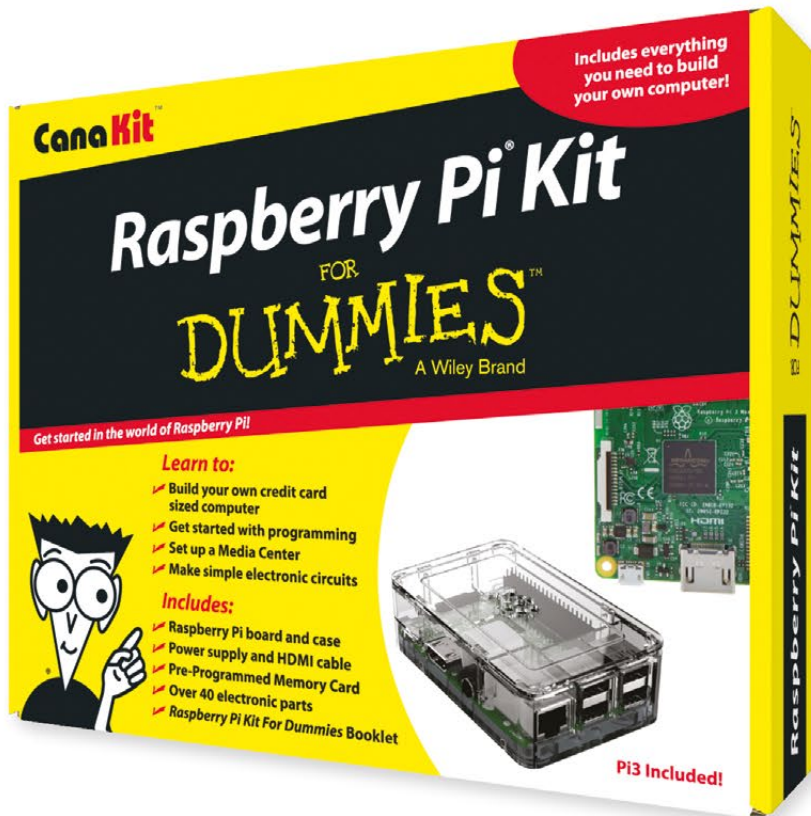

FOR
DUMMIES[®]
A Wiley Brand

Available for worldwide shipping at:

WWW.CANAKIT.COM

Available in Europe
through RS Components



Kit Includes:

- ✓ **Raspberry Pi For Dummies Booklet**
- ✓ **Raspberry Pi 3 Board**
- ✓ **Memory Card**
- ✓ **Plastic Case**
- ✓ **2.5A Power Supply**
- ✓ **HDMI Cable**
- ✓ **Resistors**
- ✓ **LEDs**
- ✓ **Push Button Switches**
- ✓ **Prototyping Breadboard**
- ✓ **Jumper Wires**
- ✓ **Heat Sinks**



\$89^{.99}
US DOLLARS

£69^{.99}
EXCLUDING VAT

Raspberry Pi is a registered trademark of the Raspberry Pi Foundation. For Dummies and the Dummies Man logo are trademarks or registered trademarks of John Wiley & Sons, Inc. Used under license. RS logo is a registered trademark of RS Components Ltd. CanaKit is a registered trademark of Cana Kit Corporation.